

# **RIGOL**

## **User's Guide**

### **DG800 Series Function/Arbitrary Waveform Generator**

Feb. 2019

**RIGOL (SUZHOU) TECHNOLOGIES INC.**



# Guaranty and Declaration

## Copyright

© 2018 **RIGOL** (SUZHOU) TECHNOLOGIES INC. All Rights Reserved.

## Trademark Information

**RIGOL** is a registered trademark of **RIGOL** (SUZHOU) TECHNOLOGIES INC.

## Publication Number

UGB11102-1110

## Software Version

00.00.01

Software upgrade might change or add product features. Please acquire the latest version of the manual from **RIGOL** website or contact **RIGOL** to upgrade the software.

## Notices

- **RIGOL** products are covered by P.R.C. and foreign patents, issued and pending.
- **RIGOL** reserves the right to modify or change parts of or all the specifications and pricing policies at the company's sole decision.
- Information in this publication replaces all previously released materials.
- Information in this publication is subject to change without notice.
- **RIGOL** shall not be liable for either incidental or consequential losses in connection with the furnishing, use, or performance of this manual, as well as any information contained.
- Any part of this document is forbidden to be copied, photocopied, or rearranged without prior written approval of **RIGOL**.

## Product Certification

**RIGOL** guarantees that this product conforms to the national and industrial standards in China as well as the ISO9001:2015 standard and the ISO14001:2015 standard. Other international standard conformance certifications are in progress.

## Contact Us

If you have any problem or requirement when using our products or this manual, please contact **RIGOL**.

E-mail: [service@rigol.com](mailto:service@rigol.com)

Website: [www.rigol.com](http://www.rigol.com)

# Safety Requirement

## General Safety Summary

Please review the following safety precautions carefully before putting the instrument into operation so as to avoid any personal injury or damage to the instrument and any product connected to it. To prevent potential hazards, please follow the instructions specified in this manual to use the instrument properly.

### **Use the BNC output connector properly.**

The BNC output connector on the front panel only allows to output the signal but not to input the signal.

### **Use Proper Power Cord.**

Only the exclusive power cord designed for the instrument and authorized for use within the local country could be used.

### **Ground the Instrument.**

The instrument is grounded through the Protective Earth lead of the power cord. To avoid electric shock, connect the earth terminal of the power cord to the Protective Earth terminal before connecting any input or output terminals.

### **Connect the Probe Correctly.**

If a probe is used, the probe ground lead must be connected to earth ground. Do not connect the ground lead to high voltage. Improper way of connection could result in dangerous voltages being present on the connectors, controls or other surfaces of the oscilloscope and probes, which will cause potential hazards for operators.

### **Observe All Terminal Ratings.**

To avoid fire or shock hazard, observe all ratings and markers on the instrument and check your manual for more information about ratings before connecting the instrument.

### **Use Proper Overvoltage Protection.**

Ensure that no overvoltage (such as that caused by a bolt of lightning) can reach the product. Otherwise, the operator might be exposed to the danger of an electric shock.

### **Do Not Operate Without Covers.**

Do not operate the instrument with covers or panels removed.

### **Do Not Insert Objects Into the Air Outlet.**

Do not insert objects into the air outlet, as doing so may cause damage to the instrument.

**Use Proper Fuse.**

Please use the specified fuses.

**Avoid Circuit or Wire Exposure.**

Do not touch exposed junctions and components when the unit is powered on.

**Do Not Operate With Suspected Failures.**

If you suspect that any damage may occur to the instrument, have it inspected by **RIGOL** authorized personnel before further operations. Any maintenance, adjustment or replacement especially to circuits or accessories must be performed by **RIGOL** authorized personnel.

**Provide Adequate Ventilation.**

Inadequate ventilation may cause an increase of temperature in the instrument, which would cause damage to the instrument. So please keep the instrument well ventilated and inspect the air outlet and the fan regularly.

**Do Not Operate in Wet Conditions.**

To avoid short circuit inside the instrument or electric shock, never operate the instrument in a humid environment.

**Do Not Operate in an Explosive Atmosphere.**

To avoid personal injuries or damage to the instrument, never operate the instrument in an explosive atmosphere.

**Keep Product Surfaces Clean and Dry.**

To avoid dust or moisture from affecting the performance of the instrument, keep the surfaces of the instrument clean and dry.

**Prevent Electrostatic Impact.**

Operate the instrument in an electrostatic discharge protective environment to avoid damage induced by static discharges. Always ground both the internal and external conductors of cables to release static before making connections.

**Use the Battery Properly.**

Do not expose the battery (if available) to high temperature or fire. Keep it out of the reach of children. Improper change of a battery (lithium battery) may cause an explosion. Use the **RIGOL** specified battery only.

**Handle with Caution.**

Please handle with care during transportation to avoid damage to keys, knobs, interfaces, and other parts on the panels.

# Safety Notices and Symbols

## Safety Notices in this Manual:



---

**WARNING**

Indicates a potentially hazardous situation or practice which, if not avoided, will result in serious injury or death.

---



---

**CAUTION**

Indicates a potentially hazardous situation or practice which, if not avoided, could result in damage to the product or loss of important data.

---

## Safety Terms on the Product:

**DANGER** It calls attention to an operation, if not correctly performed, could result in injury or hazard immediately.

**WARNING** It calls attention to an operation, if not correctly performed, could result in potential injury or hazard.

**CAUTION** It calls attention to an operation, if not correctly performed, could result in damage to the product or other devices connected to the product.

## Safety Symbols on the Product:



Hazardous Voltage



Safety Warning



Protective Earth Terminal



Chassis Ground



Test Ground

## Care and Cleaning

### Care

Do not store or leave the instrument where it may be exposed to direct sunlight for long periods of time.

### Cleaning

Clean the instrument regularly according to its operating conditions.

1. Disconnect the instrument from all power sources.
2. Clean the external surfaces of the instrument with a soft cloth dampened with mild detergent or water. Avoid having any water or other objects into the chassis via the heat dissipation hole. When cleaning the LCD, take care to avoid scarifying it.



---

#### CAUTION

To avoid damage to the instrument, do not expose it to caustic liquids.

---



---

#### WARNING

To avoid short-circuit resulting from moisture or personal injuries, ensure that the instrument is completely dry before connecting it to the power supply.

---

## Environmental Considerations

The following symbol indicates that this product complies with the WEEE Directive 2002/96/EC.



### Product End-of-Life Handling

The equipment may contain substances that could be harmful to the environment or human health. To avoid the release of such substances into the environment and avoid harm to human health, we recommend you to recycle this product appropriately to ensure that most materials are reused or recycled properly. Please contact your local authorities for disposal or recycling information.

You can click on the following link

[http://www.rigol.com/Files/RIGOL\\_RoHS2.0&WEEE.pdf](http://www.rigol.com/Files/RIGOL_RoHS2.0&WEEE.pdf) to download the latest version of the RoHS&WEEE certification file.

# DG800 Series Function/Arbitrary Waveform Generator Overview

As a multi-functional signal generator, DG800 series function/arbitrary waveform generator integrates many instruments into 1, such as function generator, arbitrary waveform generator, noise generator, pulse generator, harmonic generator, analog/digital modulator, and frequency counter. As a multi-functional and portable instrument, it offers you a new choice in education, R&D, production, measurement, and other industries with its user-friendly touch screen and high performance at an unprecedented price point.

## Main Features:

- Unique SiFi II (Signal Fidelity II) technology: generate the arbitrary waveforms point by point; recover the signal without distortion; sample rate accurate and adjustable; jitter of all the output waveforms (including Sine, Pulse, etc.) as low as 200 ps
- 2 Mpts memory depth (standard); 8 Mpts memory depth (optional) per channel for arbitrary waveforms
- Optional dual-channel with the same performance, equivalent to two independent signal sources
- High frequency stability:  $\pm 1$  ppm; low phase noise: -105 dBc/Hz
- Built-in up to 8 orders harmonics generator
- Built-in 7 digits/s, 240 MHz bandwidth full featured frequency counter
- Up to 160 built-in arbitrary waveforms, covering the common signals in engineering application, medical electronics, auto electronics, math processing, and other various fields
- Sample rate up to 125 MSa/s, vertical resolution 16 bits
- Arbitrary waveform sequence editing function available; arbitrary waveforms also can be generated through the PC software
- Various analog and digital modulation functions: AM, FM, PM, ASK, FSK, PSK, and PWM.
- Standard waveform combine function, capable of outputting specified waveforms combined with the basic waveforms
- Standard channel tracking function, when enabled, all the parameters of both channels are updated based on users' configurations
- USB HOST&DEVICE interface (standard); USB-GPIB function supported
- 4.3" TFT color touch screen
- RS232, PRBS, and Dualtone outputs supported



# Document Overview

## Main Topics in this Manual

|                                  |  |
|----------------------------------|--|
| Chapter 1 Quick Start            | Introduces the appearance and dimensions of DG800, its front/rear panel, and user interface.               |
| Chapter 2 Front Panel Operations | Introduces the main functions and operation methods of DG800.  |
| Chapter 3 Remote Control         | Introduces how to control DG800 remotely.  |
| Chapter 4 Troubleshooting        | Lists the possible failures and solutions in using DG800.  |
| Chapter 5 Appendix               | Provides the information about the options and accessories list, as well as warranty information of DG800. |

## Format Conventions in this Manual

### 1. Keys:

The keys on the front panel are usually denoted by the format of "Key Name (Bold) + Text Box". For example, **Utility** denotes the Utility key.

### 2. Menu Labels:

The menu labels are usually denoted by the format of "Menu Word (Bold) + Character Shading". For example, **System Setting**.

### 3. Connectors:

The connectors on the front or rear panel are usually denoted by the format of "Connector Name (Bold) + Square Brackets (Bold)". For example, **[Counter]**.

### 4. Operation Procedures:

"→" represents the next step of operation. For example, **Utility** → **System Setting** denotes that first press **Utility** on the front panel, and then tap the **System Setting** menu label.

## Content Conventions in this Manual

- DG800 series function/arbitrary waveform generator includes the following models: This manual takes DG832 as an example to illustrate the operation methods of the DG800 series.

| Model | No. of Channels | Max. Output Frequency |
|-------|-----------------|-----------------------|
| DG812 | 2               | 10 MHz                |
| DG822 | 2               | 25 MHz                |
| DG832 | 2               | 35 MHz                |
| DG811 | 1               | 10 MHz                |
| DG821 | 1               | 25 MHz                |
| DG831 | 1               | 35 MHz                |

2. DG800 series function/arbitrary waveform generator is equipped with two channels (CH1 and CH2). Unless otherwise specified, this manual takes CH1 as an example to introduce the operation methods of the generator. The operation methods of CH2 is the same as that of CH1.

### **Manuals of this Product**

The manuals of this product mainly include the quick guide, user's guide, programming guide, data sheet, and etc. For the latest version of this manual, download it from the official website of **RIGOL** ([www.rigol.com](http://www.rigol.com)).

# Contents

|  |            |
|--|------------|
| <b>Guaranty and Declaration .....</b>                                    | <b>I</b>   |
| <b>Safety Requirement .....</b>  | <b>II</b>  |
| General Safety Summary .....   | II         |
| Safety Notices and Symbols .....   | IV         |
| Care and Cleaning .....  | V          |
| Environmental Considerations .....                                       | V          |
| <b>DG800 Series Function/Arbitrary Waveform Generator Overview .....</b> | <b>VI</b>  |
| <b>Document Overview.....</b>  | <b>VII</b> |
| <b>Chapter 1 Quick Start .....</b>                                       | <b>1-1</b> |
| General Inspection .....   | 1-2        |
| Appearance and Dimensions.....   | 1-3        |
| Front Panel Overview.....  | 1-4        |
| Rear Panel Overview.....   | 1-8        |
| To Prepare for Use.....  | 1-11       |
| To Connect to AC Power .....   | 1-11       |
| Turn-on Checkout .....   | 1-11       |
| To Set the System Language.....  | 1-11       |
| User Interface.....  | 1-12       |
| To Use the Built-in Help System .....                                    | 1-15       |
| <b>Chapter 2 Front Panel Operations .....</b>                            | <b>2-1</b> |
| To Output Basic Waveform .....   | 2-2        |
| To Select Output Channel .....   | 2-2        |
| To Select Basic Waveform .....   | 2-3        |
| To Set Frequency/Period .....  | 2-4        |
| To Set Amplitude/High Level .....  | 2-5        |
| To Set Offset/Low Level.....   | 2-7        |
| To Set Start Phase .....   | 2-8        |
| To Set Duty Cycle (Square) .....   | 2-9        |
| To Set Symmetry (Ramp).....  | 2-10       |
| To Set Pulse Width/Duty Cycle (Pulse) .....                              | 2-11       |
| To Set Rising/Falling Edge (Pulse) .....                                 | 2-12       |
| To Enable Channel Output .....   | 2-13       |
| Align Phase .....  | 2-14       |
| Example: To Output Sine .....  | 2-15       |
| To Output the Arbitrary Waveform.....                                    | 2-17       |
| To Enable Arbitrary Waveforms.....                                       | 2-17       |
| To Select the Waveform.....  | 2-17       |
| To Set Parameters.....   | 2-22       |
| To Output Harmonic .....   | 2-23       |
| Harmonic Overview.....   | 2-23       |

|  |      |
|--|------|
| To Set Fundamental Waveform Parameters ..... | 2-24 |
| To Select Harmonic Type .....                | 2-24 |
| To Set Harmonic Order .....                  | 2-24 |
| To Select Harmonic Amplitude.....            | 2-25 |
| To Set Harmonic Phase .....                  | 2-25 |
| Example: To Output Harmonic .....            | 2-25 |
| DC.....                                      | 2-28 |
| To Output Dual-tone Waveform .....           | 2-29 |
| To Output Advanced Waveform .....            | 2-30 |
| PRBS .....                                   | 2-30 |
| RS232 .....                                  | 2-31 |
| Sequence.....                                | 2-32 |
| Modulation .....                             | 2-34 |
| Amplitude Modulation (AM) .....              | 2-34 |
| Frequency Modulation (FM) .....              | 2-38 |
| Phase Modulation (PM) .....                  | 2-41 |
| Amplitude Shift Keying (ASK) .....           | 2-44 |
| Frequency Shift Keying (FSK) .....           | 2-47 |
| Phase Shift Keying (PSK) .....               | 2-50 |
| Pulse Width Modulation (PWM) .....           | 2-53 |
| Sweep.....                                   | 2-56 |
| To Enable the Sweep Function .....           | 2-56 |
| Sweep Type .....                             | 2-56 |
| Sweep Time .....                             | 2-58 |
| Return Time.....                             | 2-58 |
| Start Frequency and Stop Frequency .....     | 2-59 |
| Center Frequency and Frequency Span .....    | 2-59 |
| Sweep Trigger Source .....                   | 2-60 |
| Marker Freq .....                            | 2-61 |
| Start Hold .....                             | 2-62 |
| Stop Hold .....                              | 2-62 |
| Burst .....                                  | 2-63 |
| To Enable the Burst Function .....           | 2-63 |
| Burst Type .....                             | 2-63 |
| Burst Delay .....                            | 2-65 |
| Burst Period .....                           | 2-66 |
| Idle Level.....                              | 2-66 |
| Burst Trigger Source .....                   | 2-67 |
| Gated Polarity .....                         | 2-68 |
| Frequency Counter .....                      | 2-69 |
| To Enable the Frequency Counter .....        | 2-69 |
| To Set the Frequency Counter .....           | 2-70 |
| Store and Recall.....                        | 2-73 |
| Storage System .....                         | 2-73 |
| File Type.....                               | 2-74 |
| Categories .....                             | 2-74 |

---

|  |            |
|--|------------|
| File Operation.....                              | 2-75       |
| Seamless Interconnection with Oscilloscope ..... | 2-79       |
| Channel Setting.....                             | 2-81       |
| Output Setting.....                              | 2-81       |
| Sync Setting.....                                | 2-83       |
| Coupling Setting .....                           | 2-85       |
| Waveform Combination .....                       | 2-89       |
| Common Settings.....                             | 2-90       |
| System Setting .....                             | 2-90       |
| Interface.....                                   | 2-92       |
| System Info.....                                 | 2-96       |
| Option .....                                     | 2-96       |
| Display Setting .....                            | 2-96       |
| Print Setting .....                              | 2-97       |
| System Utility Function .....                    | 2-98       |
| To Restore Preset.....                           | 2-98       |
| Channel Copy.....                                | 2-102      |
| To Install the Option.....                       | 2-103      |
| To Lock the Keyboard.....                        | 2-105      |
| <b>Chapter 3 Remote Control .....</b>            | <b>3-1</b> |
| Remote Control via USB .....                     | 3-2        |
| Remote Control via LAN .....                     | 3-2        |
| Remote Control via GPIB.....                     | 3-4        |
| <b>Chapter 4 Troubleshooting .....</b>           | <b>4-1</b> |
| <b>Chapter 5 Appendix .....</b>                  | <b>5-1</b> |
| Appendix A: Accessories and Options .....        | 5-1        |
| Appendix B: Warranty .....                       | 5-2        |
| <b>Index .....</b>                               | <b>1</b>   |



# Chapter 1 Quick Start

This chapter briefly introduces the appearance and dimensions of DG800 series function/arbitrary waveform generator, its front/rear panel, and user interface.

Contents in this chapter:

- General Inspection
- Appearance and Dimensions
- Front Panel Overview
- Rear Panel Overview
- To Prepare for Use
- User Interface
- To Use the Built-in Help System

## General Inspection

### 1. Inspect the packaging

If the packaging has been damaged, do not dispose the damaged packaging or cushioning materials until the shipment has been checked for completeness and has passed both electrical and mechanical tests.

The consigner or carrier shall be liable for the damage to the instrument resulting from shipment. **RIGOL** would not be responsible for free maintenance/rework or replacement of the instrument.

### 2. Inspect the instrument

In case of any mechanical damage, missing parts, or failure in passing the electrical and mechanical tests, contact your **RIGOL** sales representative.

### 3. Check the accessories

Please check the accessories according to the packing lists. If the accessories are damaged or incomplete, please contact your **RIGOL** sales representative.



## Appearance and Dimensions

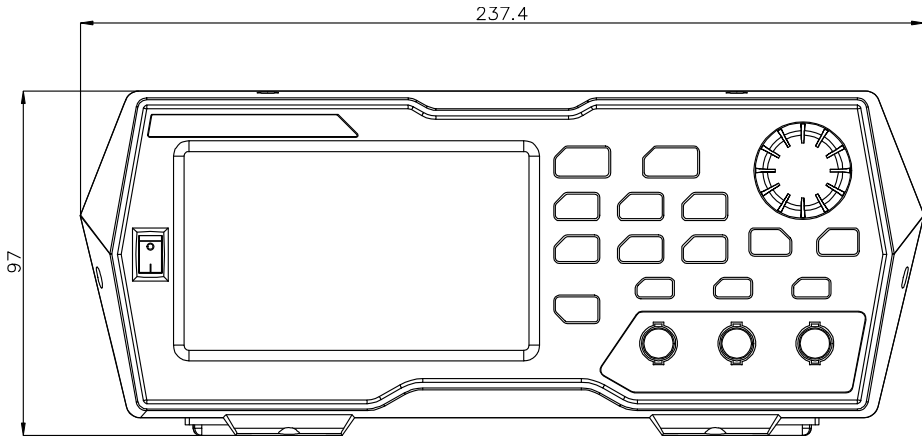

Front View

Unit: mm

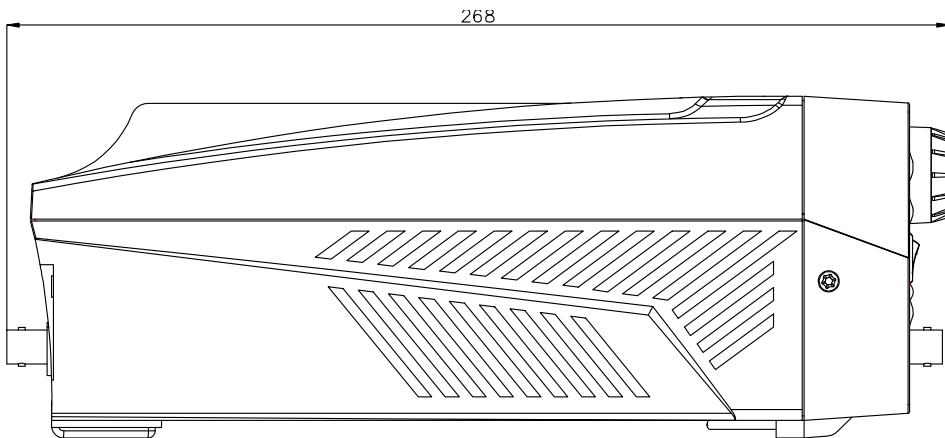

Side View

Unit: mm

# Front Panel Overview

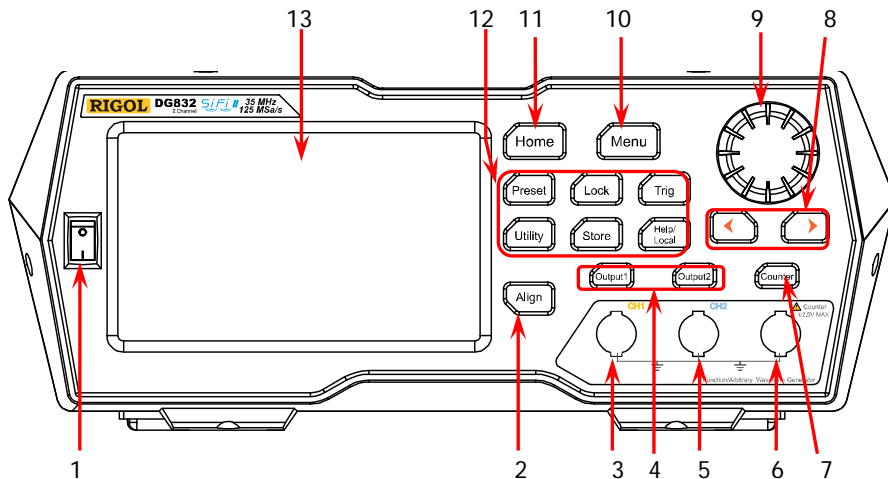

Figure 1-1 Front Panel

### 1. Power Key

Turns on or off the generator.

### 2. Align Key

Performs the phase alignment operation. For details, refer to descriptions in "Align Phase".

### 3. CH1 Output Connector

BNC connector, with 50 Ω nominal output impedance.

When **Output1** is enabled (the backlight turns on), this connector outputs waveforms according to the current configuration of CH1.

### 4. Channel Control Area



It is used to control the output of CH1.

- Press this key to enable the output of CH1, the backlight turns on. At this time, the **[CH1]** connector outputs the waveforms according to the current configuration of CH1.
- Press this key again to disable the output of CH1, and the backlight turns off.



It is used to control the output of CH2.

- Press this key to enable the output of CH2, the backlight turns on. At this time, the **[CH2]** connector outputs the waveforms according to the current configuration of CH2.
- Press this key again to disable the output of CH2, and the backlight turns off.

## 5. CH2 Output Connector

BNC connector, with 50  $\Omega$  nominal output impedance.

When **Output2** is enabled (the backlight turns on), this connector outputs waveforms according to the current configuration of CH2.

## 6. Counter Measurement Signal Input Connector

BNC connector, with 1 M $\Omega$  input impedance. It is used to receive the signal measured by the counter.



### CAUTION

To avoid damages to the instrument, the input signal voltage cannot exceed  $\pm 2.5$  V.

---

## 7. Frequency Counter

Enables or disables the frequency counter.

- Press this key to enable the frequency counter, and the backlight turns on and blinks continuously.
- Press this key again to disable the frequency counter, and the backlight turns off. At this time, the frequency counter is disabled.

**Note:** When the frequency counter is enabled, no waveforms will be output from the CH2 connector. When the frequency counter is disabled, waveforms are allowed to be output from the CH2 connector.

## 8. Arrow Key

- It is used to move the cursor to select the digit to be edited when you use the knob to set the parameters (pressing down the knob can enter the editing mode).
- In the user interface, it is used to move left or right the cursor.

## 9. Knob

- When you select a menu label in the interface, the knob can be used to move the cursor down (clockwise) or up (counterclockwise).
- It can be used to increase (clockwise) or decrease (counterclockwise) the value marked by the cursor when you use the knob to set the parameters (pressing down the knob can enter the editing mode). Press down the knob again to exit the editing mode.
- It can be used to select the desired waveform by moving the cursor with the knob when you select the waveform (pressing the right arrow key will locate the cursor to the right of the interface). Press down the knob to select the desired waveform.
- When you store or read a file, it can be used to select a storage location or select a file to be read. Press down the knob to unfold the currently selected directory.
- It can be used to select the desired parameter by moving the cursor with the knob when you set the common information (pressing the right arrow key will locate the cursor to the right of the interface). Press down the knob

to select the desired parameter. Then, rotate the knob to modify the parameter, and press it down again to confirm your modification.

- It is used to select the desired configuration type in the Preset interface. Press down the knob to confirm your selection. At this time, a dialog box is displayed. Use the knob to select the corresponding button, then press down the knob to perform the corresponding operation (note that only when the button turns green, can your operation on the knob be valid).

## 10. Menu Key

Enters the waveform mode selection interface.

## 11. Home Key

Enters the main interface of the instrument.

## 12. Function Keys



Restores the instrument to its preset state. At most 10 states can be preset.



Locks or unlocks the front-panel keys and the touch screen. In the unlocked state, press **Lock** to lock the front-panel keys and the touch screen. At this time, except the **Lock** key, all other keys on the front panel and the touch screen operation are invalid. Press the **Lock** key again to unlock the keys and the touch screen.



Used for manual trigger.

- The default trigger setting for the generator is Internal trigger. In this mode, when you select the sweep or burst mode, the generator outputs the waveforms continuously. At this time, press the **Trig** key, and instrument automatically switches to the manual trigger mode from auto trigger.
- Each time you press the **Trig** key, one sweep will be triggered manually or one burst will be output.



It is used to set the utility function parameters and system parameters.



Stores or recalls the instrument state or the user-defined arbitrary waveform data. A non-volatile memory (Disk C) is built in, and a USB storage device (Disk D) can be externally connected.



Gets the help information of any front-panel keys and the help information of the current interface.

**Note:** When the instrument is in the remote mode, press this key to return to the local mode.

### 13. LCD

4.3-inch TFT (480×272) color LCD display. The menu label and parameter settings of the current function, system state, prompt messages, and other information can be clearly displayed on the LCD. For details, refer to descriptions in "**User Interface**".

## Rear Panel Overview

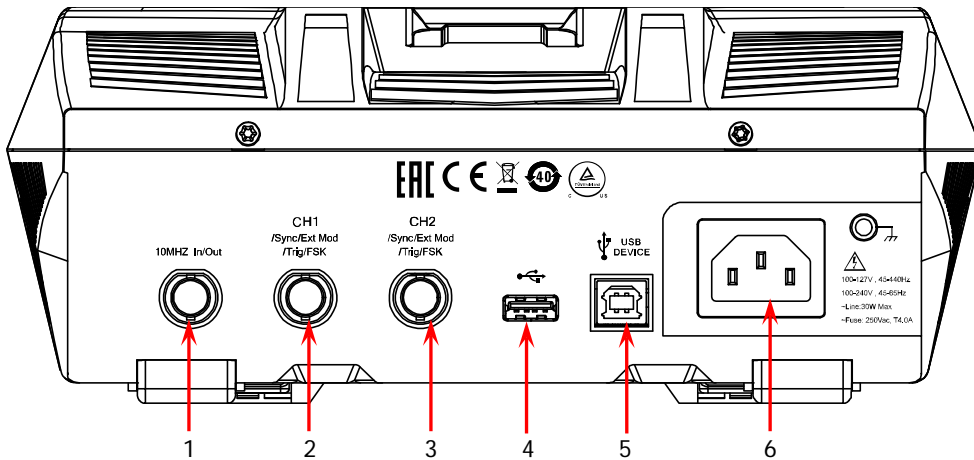

Figure 1-2 Rear Panel

### 1. [10MHz In/Out]

BNC female connector, with 50  $\Omega$  nominal impedance. Its function is determined by the clock type used by the instrument.

1) When internal clock source is selected, this connector (as 10MHz Out) outputs the 10 MHz clock signal generated by the internal crystal oscillator inside the generator.

2) When external clock source is selected, this connector (as 10MHz In) receives an external 10 MHz clock signal.

This connector is usually used to realize synchronization among multiple instruments. For details about the signals mentioned above, please refer to the descriptions in "**Clock Source**".

### 2. [CH1/Sync/Ext Mod/Trig/FSK]

BNC female connector, with 50  $\Omega$  nominal impedance. Its function is determined by the current working mode of CH1.

#### 1) Sync

When the output of CH1 is enabled, this connector outputs the corresponding sync signal that matches the current configuration of CH1. For detailed information about the characteristics of the sync signals that correspond to various output signals, refer to the descriptions in "**Sync Setting**".

#### 2) Ext Mod

When AM, FM, PM, or PWM of CH1 is enabled and external modulation source is selected, this connector receives an external modulation signal. Its input impedance is 1000  $\Omega$ . For details, refer to descriptions in "**Modulation**".

- 3) **FSK**  
When ASK, FSK, or PSK of CH1 is enabled and external modulation source is selected, this connector receives an external modulation signal whose polarity can be set by users. Its input impedance is 1000  $\Omega$ . For details, refer to descriptions in "**Modulation**".
  - 4) **Trig In**  
When Sweep or Burst of CH1 is enabled and external trigger source is selected, this connector receives an external trigger signal whose polarity can be set by users.
  - 5) **Trig Out**  
When Burst of CH1 is enabled, and the internal/manual trigger source is selected, this connector outputs a trigger signal with specified edge type.
3. **[CH2/Sync/Ext Mod/Trig/FSK]**  
BNC female connector, with 50  $\Omega$  nominal impedance. Its function is determined by the current working mode of CH2.
- 1) **Sync**  
When the output of CH2 is enabled, this connector outputs the corresponding sync signal that matches the current configuration of CH2. For detailed information about the characteristics of the sync signals that correspond to various output signals, refer to the descriptions in "**Sync Setting**".
  - 2) **Ext Mod**  
When AM, FM, PM or PWM of CH2 is enabled and external modulation source is selected, this connector receives an external modulation signal. Its input impedance is 1000  $\Omega$ . For details, refer to descriptions in "**Modulation**".
  - 3) **FSK**  
When ASK, FSK, or PSK of CH2 is enabled and external modulation source is selected, this connector receives an external modulation signal whose polarity can be set by users. Its input impedance is 1000  $\Omega$ . For details, refer to descriptions in "**Modulation**".
  - 4) **Trig In**  
When Sweep or Burst of CH2 is enabled and external trigger source is selected, this connector receives an external trigger signal whose polarity can be set by users.
  - 5) **Trig Out**  
When Burst of CH2 is enabled, and the internal/manual trigger source is selected, this connector outputs a trigger signal with specified edge type.
4. **USB HOST**  
Supports FAT32 format Flash type USB storage device, **RIGOL** TMC digital oscilloscope (DS), and the USB-GPIB interface converter.
- USB storage device: reads the waveform files or state files saved in the USB storage device; or stores the current instrument states or edited waveform data into the USB storage device. Besides, the contents displayed on the

screen can also be saved to the USB storage device in the format of an image (\*.Bmp).

- TMC DS: seamlessly interconnects with the **RIGOL** DS that meets the TMC standard. Reads and stores the waveform data collected by the DS and rebuilds waveforms without distortion.
- USB-GPIB interface converter (optional accessory): extends the GPIB interface for **RIGOL** instruments that integrates the USB HOST interface but not the GPIB interface.

## 5. USB DEVICE

It is used to connect the generator to a computer which can control the generator remotely by using PC software or by programming.

## 6. AC Power Cord Connector

The rated AC power source supported by the signal generator is (100-127 V, 45-440 Hz) or (100-240 V, 45-65 Hz), and its maximum input power shall not exceed 30 W. The specification of the fuse is 250 Vac, T4.0 A.



## To Prepare for Use

### To Connect to AC Power

Please use the power cord provided in the accessories to connect the signal generator to the AC power source, as shown in the figure below. The rated AC power source supported by the signal generator is (100-127 V, 45-440Hz) or (100-240 V, 45-65Hz), and its maximum input power shall not exceed 30 W. When the signal generator is connected to the AC power source via the power cord, the instrument automatically adjusts itself to within the proper voltage range, and you do not need to select the voltage range manually.

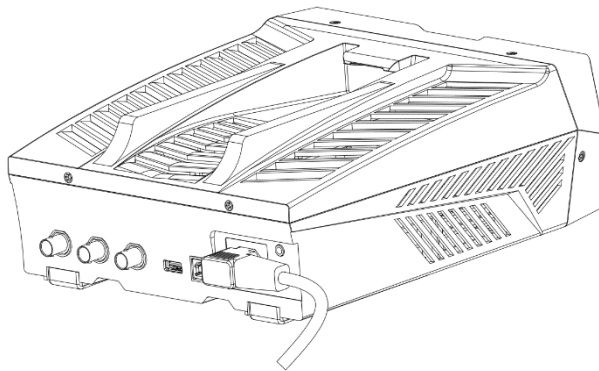

#### CAUTION

To avoid electric shock, ensure that the instrument is correctly grounded.

### Turn-on Checkout

After connecting the instrument to the power source properly, press  on the front panel to start the signal generator. During the start-up, the instrument will undergo the initialization and self-check process. Then, it will enter a default interface. If you still fail to power on the instrument normally, refer to the methods in "**Troubleshooting**" to resolve the problem.

### To Set the System Language

DG800 arbitrary waveform generator supports multiple languages. You can press **Utility** → **System Setting**, and then select a desired language from the "Language" drop-down list.

# User Interface

The DG800 user interface is shown in the following figure.

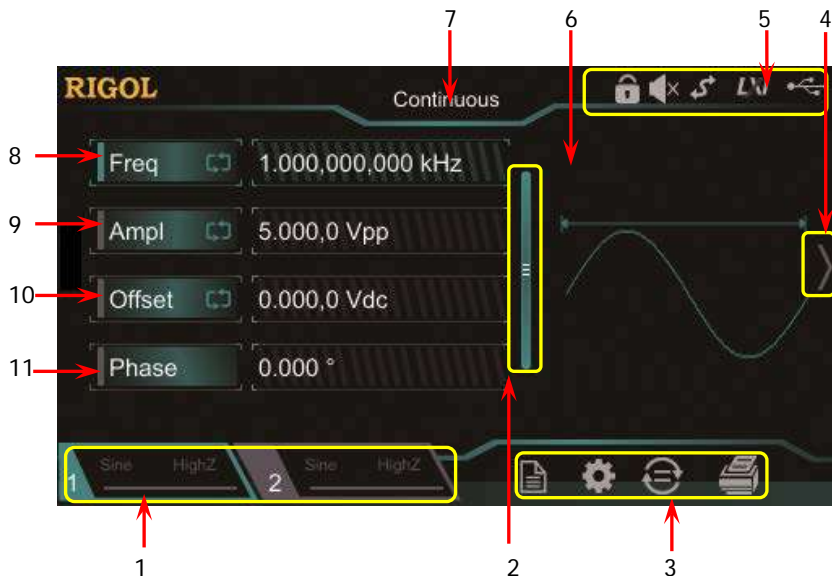

Figure 1-1 User Interface

## 1. Channel Output Configuration Status Bar

Displays the current output configuration of the channel.

- Selected Waveform: Sine/Square/Ramp/Pulse/Noise/Prbs/Dualtone/Harm /Rs232/DC/Arb/Sequence
- Modulation Type: AM/FM/PM/ASK/FSK/PSK/PWM
- Sweep Type: Linear/Log/Step
- Burst Type: Ncycle/Infinite/Gated



**Channel Output State:**  
ON: illuminated in yellow.  
OFF: grayed out.

**Output Impedance Type:**  
High impedance: displays HighZ.  
Load: displays impedance (the default is 50 Ω and the range is from 1 Ω to 10 kΩ).

**Note:** Two channels can be enabled simultaneously, but you cannot select both channels at the same time.

## 2. Up and Down Scroll Bar

Prompts you to move up and down with your fingers on the screen to view and set parameters.

## 3. Information Setting



: opens the Store interface.



: opens the Utility interface.



: performs the channel copy function.



: performs the screen print operation.

## 4. Right Arrow

Prompts you to slide right on the screen to switch to the waveform selection interface.

## 5. Status Bar



: indicates that the front-panel keys and the screen are locked.



: indicates that the beeper is disabled.



: indicates that the instrument is in programming-controlled mode.



: indicates that the instrument has been successfully connected to the local area network by using the network cable.



: indicates that a USB storage device is found.

## 6. Waveform

Displays the currently selected waveform of each channel.

## 7. Interface Label

Displays the label of the current interface.

## 8. Frequency

Displays the frequency of the current waveform of each channel. Tap the **Freq** parameter input field to modify the parameter with the pop-up numeric keypad. You can also use the arrow keys and the knob to modify the parameter.

## 9. Amplitude

Displays the amplitude of the current waveform of each channel. Tap the **Ampl** parameter input field to modify the parameter with the pop-up numeric keypad. You can also use the arrow keys and the knob to modify the parameter.

## 10. Offset

Displays the DC offset of the current waveform of each channel. Tap the **Offset** parameter input field to modify the parameter with the pop-up numeric keypad. You can also use the arrow keys and the knob to modify the parameter.

**11. Phase**

Displays the phase of the current waveform of each channel. Tap the **Phase** parameter input field to modify the parameter with the pop-up numeric keypad. You can also use the arrow keys and the knob to modify the parameter.

## To Use the Built-in Help System

DG800 series provides the help information for each front-panel function menu and the current display interface. You can view the help information if you have any questions during the operation process.

### 1. Obtain the help information of the front panel keys

To get the help information about any front-panel key or menu softkey, press the **Help/Local** key first, and then press the desired key for the help information. Then, the corresponding help information is displayed.

### 2. Obtain the common help topics

Press **Help/Local** on the front panel, and then the following interface is displayed below. Tap **"Help"** to enter the help interface. At this time, you can tap on the touch screen to move up and down the help items or rotate the knob to scroll up and down the list to select the desired help item. Then, the help information for the item is displayed in the interface.

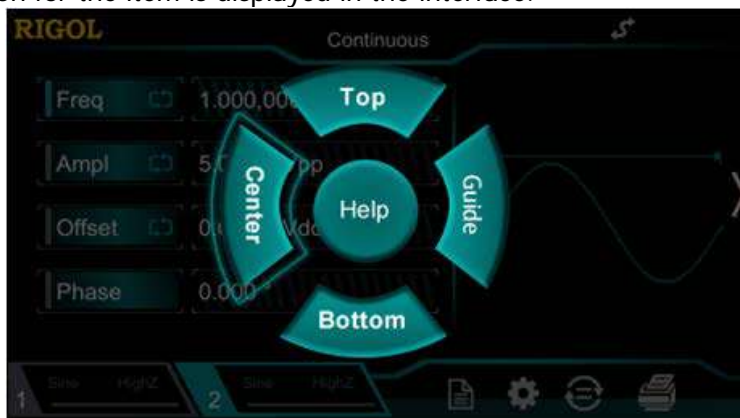

### 3. Obtain the descriptions of the data in the interface

Press **Help/Local** on the front panel to enter the interface, as shown above. Tap **"Center"** to view the descriptions for the data in the center of the current interface. Tap **"Top"** to view the descriptions for the data in the top part of the current interface. Tap **"Bottom"** to view the descriptions for the data in the bottom part of the current interface. Tap **"Guide"** to enter the guide interface.

### 4. Page up/down operation

When the help information is displayed in multiple pages, you can tap to move up and down the touch screen to view the help information.

### 5. Close the current help information

When the help information is displayed in the interface, press **Help/Local** on the front panel to close the help information currently displayed on the screen.



## Chapter 2 Front Panel Operations

Introduces the main functions and operation methods of DG800.

Contents in this chapter:

- To Output Basic Waveform
- To Output the Arbitrary Waveform
- To Output Harmonic
- DC
- To Output Dual-tone Waveform
- To Output Advanced Waveform
- Modulation
- Sweep
- Burst
- Frequency Counter
- Store and Recall
- Channel Setting
- Common Settings
- System Utility Function

## To Output Basic Waveform

DG800 series can output basic waveforms (including Sine, Square, Ramp, Pulse, and Noise) from one channel or from both two channels at the same time. At start-up, the dual channels are configured to output a sine waveform with 1 kHz frequency and 5 Vpp amplitude by default. Users can configure the instrument to output various basic waveforms.

## To Select Output Channel

At start-up, the instrument displays the CH1 parameter interface by default. You can press **Output1** or **Output2** (also, you can tap the channel output configuration status bar or ) to switch between CH1 and CH2 as the currently selected channel.

After the desired channel is selected, you can configure the waveform and parameters of the selected channel.

### Key Points:





CH1 and CH2 cannot be both selected at the same time. You can first select CH1, after configuring the waveform and parameters of CH1, then select CH2 for configuration.



## To Select Basic Waveform

DG800 can output 5 basic waveforms, including Sine, Square, Ramp, Pulse and Noise. Press **Menu** on the front panel, then tap the touch screen to select the desired waveform. After selecting the desired waveform, you are automatically directed to the waveform parameter setting interface. To go back to the waveform selection interface, tap to slide right or press the **Menu** key on the front panel. At start-up, Sine is selected by default.

Table 2-1 Basic Waveforms

| Basic Waveforms | Sine   | Square   | Ramp   | Pulse  | Noise   |
|-----------------|--|--|--|--|---|
|                 |  Sine |  Square |  Ramp |  Pulse |  Noise |
| Function Name   | Sine   | Square   | Ramp   | Pulse  | Noise   |
| Freq/Period     | ✓  | ✓  | ✓  | ✓  |   |
| Ampl/HighL      | ✓  | ✓  | ✓  | ✓  | ✓   |
| Offset/LowL     | ✓  | ✓  | ✓  | ✓  | ✓   |
| Start Phase     | ✓  | ✓  | ✓  | ✓  |   |
| Align Phase     | ✓  | ✓  | ✓  | ✓  |   |
| Duty            |  | ✓  |  | ✓  |   |
| Symmetry        |  |  | ✓  |  |   |
| Width/Duty      |  |  |  | ✓  |   |
| RisEdge         |  |  |  | ✓  |   |
| FallEdge        |  |  |  | ✓  |   |

## To Set Frequency/Period

Frequency is one of the most important parameters of basic waveforms. For different instrument models and waveforms, the setting ranges of frequency are different. The default frequency is 1 kHz.

|             | Sine                 | Square               | Ramp                  | Pulse                | Noise (-3 dB)     |
|-------------|----------------------|----------------------|-----------------------|----------------------|-------------------|
| DG812/DG811 | 1 $\mu$ Hz to 10 MHz | 1 $\mu$ Hz to 5 MHz  | 1 $\mu$ Hz to 200 kHz | 1 $\mu$ Hz to 5 MHz  | 100 MHz Bandwidth |
| DG822/DG821 | 1 $\mu$ Hz to 25 MHz | 1 $\mu$ Hz to 10 MHz | 1 $\mu$ Hz to 500 kHz | 1 $\mu$ Hz to 10 MHz | 100 MHz Bandwidth |
| DG832/DG831 | 1 $\mu$ Hz to 35 MHz | 1 $\mu$ Hz to 10 MHz | 1 $\mu$ Hz to 1 MHz   | 1 $\mu$ Hz to 10 MHz | 100 MHz Bandwidth |

The frequency displayed on the screen is the default value or the frequency previously set. When the instrument function is changed, if this frequency is valid under the new function, the instrument will still use this frequency; otherwise, the instrument would display a prompt message and set the frequency to the frequency upper limit of the new function automatically.

Tap the **Freq** parameter input field to input the desired frequency value with the numeric keypad, then select the unit. Tap "Ok".

- The frequency units available are MHz, kHz, Hz, mHz, and  $\mu$ Hz.
- Tap the label again to switch to Period setting.
- The period units available are s, ms,  $\mu$ s, and ns.

You can also use the arrow keys and the knob to set the parameter value: press down the knob to enter the editing mode, use the arrow keys to move the cursor to select the digit to be edited, and then rotate the knob to modify the value. Besides, you can use the knob to switch between different parameters.

## To Set Amplitude/High Level

The amplitude setting range is limited by the "Impedance" and "Freq/Period" settings. By default, it is 5 Vpp.

The amplitude displayed on the screen is the default value or the amplitude previously set. When the instrument configuration (e.g. frequency) is changed, if this amplitude is valid, the instrument will still use this amplitude; otherwise, the instrument would display a prompt message and set the amplitude to the amplitude upper limit of the new configuration automatically. You can also use "High Level" or "Low Level" to set the amplitude.

Tap the **Ampl** parameter input field to input the desired frequency value with the numeric keypad, then select the unit. Tap **"Ok"**.

- The amplitude units available are Vpp, mVpp, Vrms, mVrms, and dBm (invalid in HighZ).
- Tap the label again to switch to High Level setting.
- The high level units available are V and mV.

You can also use the arrow keys and the knob to set the parameter value: press down the knob to enter the editing mode, use the arrow keys to move the cursor to select the digit to be edited, and then rotate the knob to modify the value. Besides, you can use the knob to switch between different parameters.

### Key Points:

#### 1. How to convert the amplitude in Vpp to the corresponding value in Vrms?

##### Method:

Vpp is the unit for signal peak-peak value and Vrms is the unit for root-mean-square value. The default unit is Vpp. When you set the amplitude, input a decimal point in the numeric keypad, and then select a unit. Tap **"Ok"** to switch to the unit of the current amplitude.

##### Remarks:

For different waveforms, the relation between Vpp and Vrms is different. The relation of the two units is as shown in the figure below (take sine waveform as an example).

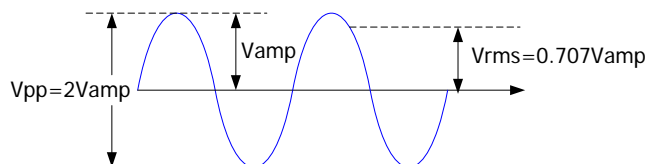





According to the figure above, the conversion relation between  $V_{pp}$  and  $V_{rms}$  fulfills the following equation:

$$V_{pp} = 2\sqrt{2}V_{rms}$$

For example, if the current amplitude is 5  $V_{pp}$ , input a decimal point in the numeric keypad, and then select a unit  $V_{rms}$ . Tap "Ok". Then, it can be converted to a value with  $V_{rms}$  as the unit. For sine waveform, the converted value is 1.768  $V_{rms}$ .

## 2. How to set the amplitude of the waveform in dBm?

### Method:

- 1) Press **Output1** or **Output2** (also, you can tap the channel output configuration status bar or  ) to select the desired channel.
- 2) Tap the channel output configuration status bar  (CH1) or  (CH2). In the channel setting interface, tap the **OutputSet** menu label and select "Off". Then use the numeric keypad to set a proper load value.
- 3) Select the desired waveform, tap the **Ampl** menu label, and then input the desired value by using the numeric keypad. Then select the unit "dBm" from the pop-up menu.

### Remarks:

dBm is the unit for signal power absolute value, and the conversion relation between dBm and  $V_{rms}$  fulfills the following equation:

$$dBm = 10\lg\left(\frac{V_{rms}^2}{R} \times \frac{1}{0.001W}\right)$$

Wherein, R represents the channel output impedance value and it must be a specific value, so the unit dBm is not available when the output impedance is "HighZ".

For example, if the current output impedance is 50  $\Omega$  and the amplitude is 1.768  $V_{rms}$  (i.g. 5  $V_{pp}$ ), input a decimal point in the numeric keypad and then select "dBm". Tap "Ok" to convert the amplitude value to the corresponding value in dBm. The converted value is 17.9601 dBm.

## To Set Offset/Low Level

The DC offset setting range is limited by the "Impedance" and "Amplitude/High Level" settings. The default value is  $0 V_{dc}$ .

The DC offset voltage displayed on the screen is the default value or the offset previously set. When the instrument configuration (e.g. impedance) is changed, if this offset is valid, the instrument will still use this offset; otherwise, the instrument would display a prompt message and set the offset to the offset upper limit of the new configuration automatically.

Tap the **Offset** parameter input field to input the desired offset value with the numeric keypad, then select the unit. Tap **"Ok"**.

- The DC offset voltage units available are  $V_{dc}$  and  $mV_{dc}$ .
- Tap the label again to switch to Low Level setting.
- The low level should be at least 1 mV smaller than the high level (output impedance:  $50 \Omega$ ).
- The low level units available are V and mV.

You can also use the arrow keys and the knob to set the parameter value: press down the knob to enter the editing mode, use the arrow keys to move the cursor to select the digit to be edited, and then rotate the knob to modify the value. Besides, you can use the knob to switch between different parameters.

## To Set Start Phase

The setting range of start phase is from 0° to 360°. The default is 0°.

The start phase displayed on the screen is the default value or the phase previously set. When the instrument function is changed, the new function will still use this phase.

Tap the **Phase** parameter input field to input the desired phase value with the numeric keypad, then select the unit "°". Tap **Ok**.

You can also use the arrow keys and the knob to set the parameter value: press down the knob to enter the editing mode, use the arrow keys to move the cursor to select the digit to be edited, and then rotate the knob to modify the value. Besides, you can use the knob to switch between different parameters.

## To Set Duty Cycle (Square)

Duty cycle is defined as the percentage that the high level takes up in the whole period (as shown in the figure below). This parameter is only available when Square or Pulse is selected.

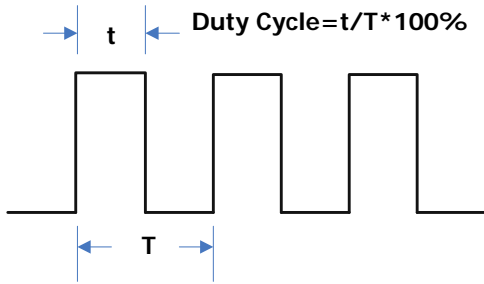

The available range of the duty cycle is from 0.01% to 99.99% (limited by the current frequency setting). The default is 50%.

Tap the **Duty** parameter input field to input the desired duty cycle value with the numeric keypad, then select the unit "%". Tap **Ok**.

You can also use the arrow keys and the knob to set the parameter value: press down the knob to enter the editing mode, use the arrow keys to move the cursor to select the digit to be edited, and then rotate the knob to modify the value. Besides, you can use the knob to switch between different parameters.

## To Set Symmetry (Ramp)

Symmetry is defined as the percentage that the rising period of the ramp takes up in the whole period (as shown in the figure below). This parameter is only available when Ramp is selected.

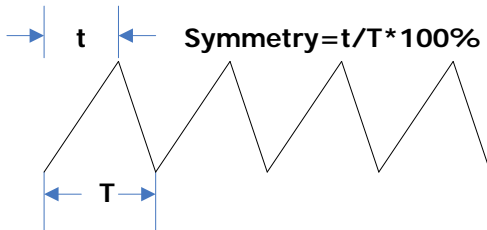

The setting range of symmetry is from 0% to 100%. The default is 50%.

Tap the **Symm** parameter input field to input the desired symmetry value with the numeric keypad, then select the unit "%". Tap **Ok**.

You can also use the arrow keys and the knob to set the parameter value: press down the knob to enter the editing mode, use the arrow keys to move the cursor to select the digit to be edited, and then rotate the knob to modify the value. Besides, you can use the knob to switch between different parameters.



## To Set Pulse Width/Duty Cycle (Pulse)

Pulse width is defined as the time from the 50% threshold of a pulse's rising edge to the 50% threshold of the next falling edge (as shown in the figure below).

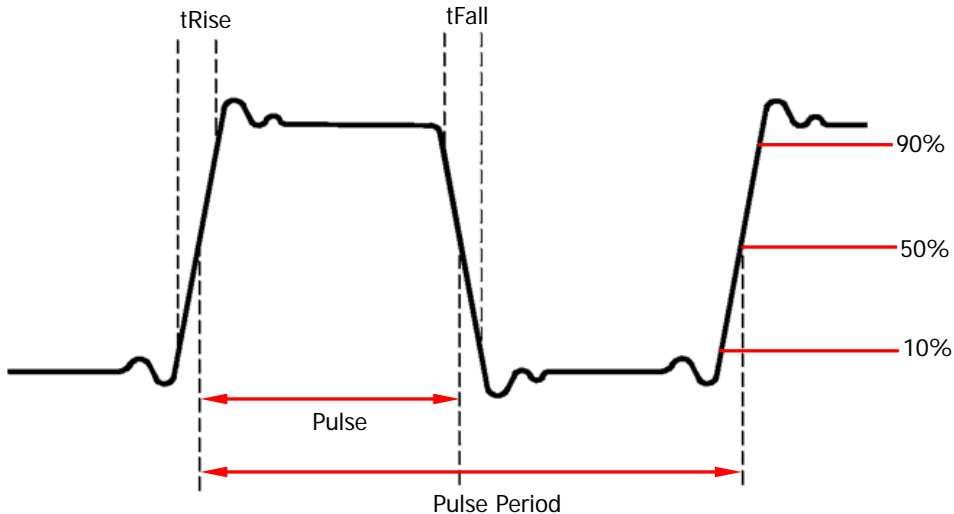

The settable range of the pulse width is from 16 ns to 999.999982118 ks (limited by "minimum pulse width" and "pulse period"). The default is 500  $\mu$ s.

- Pulse Width  $\geq$  Minimum Pulse Width
- Pulse Width  $<$  Pulse Period - 2  $\times$  Minimum Pulse Width

Pulse duty cycle is defined as the percentage that the pulse width takes up in the whole pulse period.

Pulse duty cycle and pulse width are correlative. Modifying either of them (pulse duty cycle or pulse width) will automatically affect the other. The settable range of the pulse duty cycle is from 0.001% to 99.999% (limited by "minimum pulse width" and "pulse period"). The default is 50%.

- Pulse Duty Cycle  $\geq$  100  $\times$  Minimum Pulse Width  $\div$  Pulse Period
- Pulse Duty Cycle  $<$  100  $\times$  (1 - 2  $\times$  Minimum Pulse Width  $\div$  Pulse Period)

Tap the **Width** parameter input field to input the desired pulse width value with the numeric keypad, then select the unit. Tap "Ok".

- The pulse width units available are s, ms,  $\mu$ s, and ns.
- Tap this menu label again to switch to duty cycle setting.

You can also use the arrow keys and the knob to set the parameter value: press down the knob to enter the editing mode, use the arrow keys to move the cursor to select the digit to be edited, and then rotate the knob to modify the value. Besides, you can use the knob to switch between different parameters.

## To Set Rising/Falling Edge (Pulse)

The rising edge time is defined as the duration of the pulse amplitude rising from 10% to 90% threshold, while falling edge time is defined as the duration of the pulse amplitude moving down from 90% to 10% threshold (as shown in the figure below).

The setting range of rising/falling edge time is limited by the currently specified pulse width limit (as shown in the formula below). DG800 will automatically adjust the edge time to match the specified pulse width if the value currently set exceeds the limit value.

$$\text{Rising/Falling Edge Time} \leq 0.625 \times \text{Pulse Width}$$

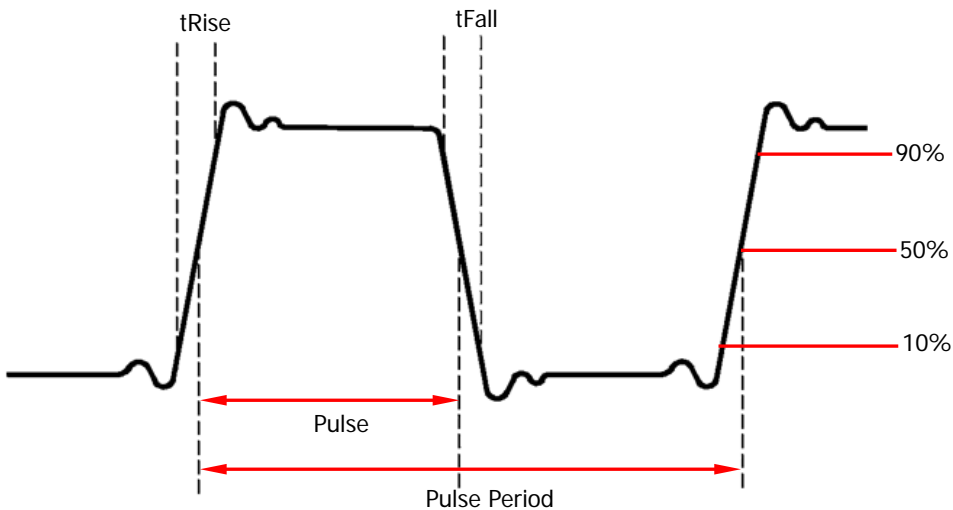

Tap the **RisEdge** or **FallEdge** parameter input field. Use the numeric keypad to input the desired value and then select the desired unit from the pop-up menu.



- The pulse width units available are sec, msec,  $\mu$ sec, and nsec.
- The rising and falling edge time are independent of each other, and users can set them separately.

You can also use the arrow keys and the knob to set the parameter value: press down the knob to enter the editing mode, use the arrow keys to move the cursor to select the digit to be edited, and then rotate the knob to modify the value. Besides, you can use the knob to switch between different parameters.

## To Enable Channel Output

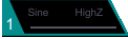
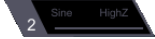
After configuring the parameters of the waveform selected, enable the channel to output the waveforms.

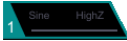
Before enabling channel output, you can also tap  or  and then tap the corresponding menu label in the channel setting interface to set the parameters related with the channel output. For details, refer to descriptions in "**Channel Setting**".

Press **Output1** or **Output2** on the front panel, and then the backlight turns on. You can also tap the channel output configuration status bar  or  enable the channel output in the channel setting interface. When the channel status bar is highlighted, (i.g. ) , the configured waveforms are output from the corresponding output connector on the front panel.

## Align Phase

DG800 series dual-channel function/arbitrary waveform generator enables you to align the phases of the two channels. Press **Align** on the front panel, then the instrument will re-configure the two channels and enable the generator to output with specified frequency and start phase.

For two signals whose frequencies are the same or in multiple relationship, this operation can align their phases. For example, assume a sine waveform (1 kHz, 5 Vpp, 0°) is output from CH1, while another one (1 kHz, 5 Vpp, 180°) from CH2. Use the oscilloscope to acquire the waveforms of the two channels and stably display the waveforms. It can be found that the phase deviation between the two waveforms is no longer 180°. At this point, press **Align** on the generator and the waveforms shown on the oscilloscope will have a phase deviation of 180° without manual adjustment of the start phase of the generator.

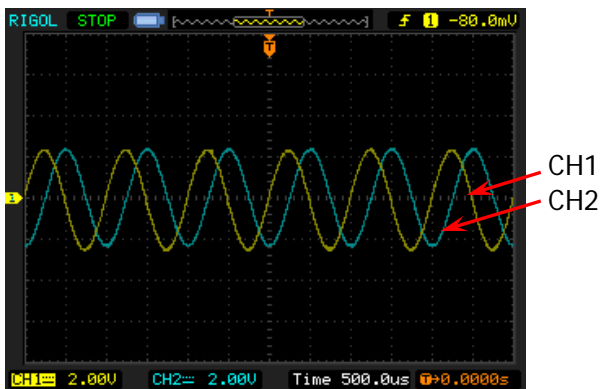

Figure 2-1 Before Aligning Phase

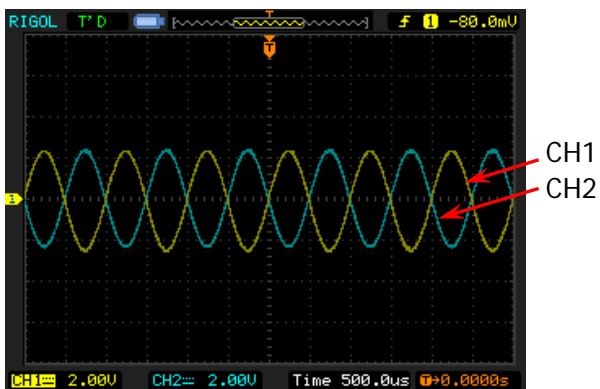
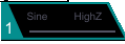



Figure 2-2 After Aligning Phase

## Example: To Output Sine

This section mainly introduces how to output Sine waveforms (frequency 20 kHz, amplitude 2.5 V<sub>pp</sub>, offset 500 mV<sub>dc</sub>, start phase 90°) from the [CH1] connector.

- 1. Select the output channel:** Press **Output1** on the front panel or tap the channel output configuration status bar  to select CH1.
- 2. Select Sine waveforms:** Press **Menu** on the front panel, and then the waveform selection interface is displayed. Tap **Continuous** and then select the "Sine" icon to go to the sine waveform parameter setting interface automatically.
- 3. Set frequency:** Tap the **Freq** parameter input field to input 20 with the pop-up numeric keypad, and then select the unit "kHz". Tap "Ok".
- 4. Set amplitude:** Tap the **Ampl** parameter input field to input 2.5 with the pop-up numeric keypad, and then select "Vpp" as the unit. Tap "Ok".
- 5. Set offset voltage:** Tap the **Offset** parameter input field to input 500 with the pop-up numeric keypad, and then select "mVdc" as the unit. Tap "Ok".
- 6. Set start phase:** Tap the **Phase** parameter input field to input 90 with the pop-up numeric keypad, and then select "°" as the unit. Tap "Ok".
- 7. Enable channel output:** Press **Output1** and the backlight turns on. Also, you can tap the channel output configuration status bar  to enable the channel output. Then, the channel status is highlighted (i.g. ) , and the Sine signal is output from the [CH1] connector based on the current configurations.
- 8. Observe the output waveform:** Connect the [CH1] connector of DG800 to the oscilloscope by using the BNC cable. The waveform is as shown in the figure below.

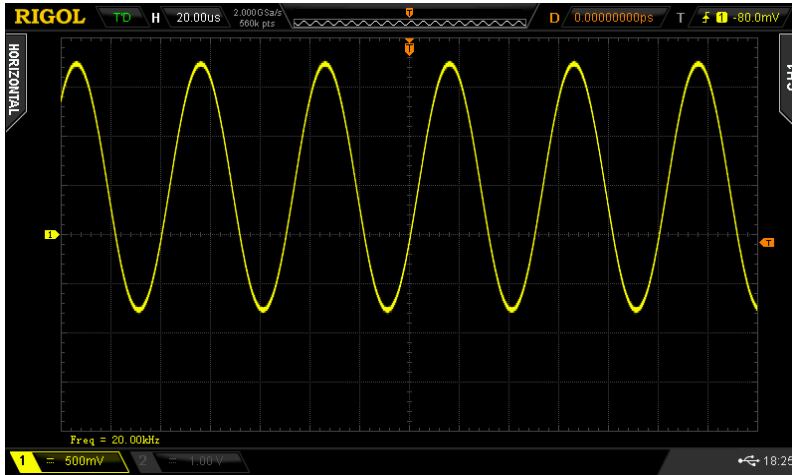

Figure 2-3 Sine Waveform

## To Output the Arbitrary Waveform

DG800 can output built-in waveforms from a single channel or from two channels at the same time. The 160 kinds of built-in arbitrary waveforms are stored in the internal non-volatile memory.

## To Enable Arbitrary Waveforms

Press **Menu** → **Continuous** → "Arb" to enable arbitrary waveform function and open the arbitrary waveform selection interface, as shown in the figure below.



Figure 2-4 Arbitrary Waveform Selection Interface

## To Select the Waveform

DG800 allows users to select 160 built-in waveforms and arbitrary waveforms stored in the internal or external memory of the instrument.

### Key Points:

After selecting the desired waveform, press the corresponding channel output control key (**Output1** or **Output2**), and the specified waveform will be output from the channel. For details, refer to descriptions in "**To Enable Channel Output**". Note that when the frequency of the arbitrary waveforms is greater than 1 MHz, some waveforms will be distorted.

## Built-in Waveform

DG800 has 160 built-in arbitrary waveforms, as shown in Table 2-2. In the arbitrary waveform selection interface, tap the **Engineering**, **Medical**, **AutoElec**, or **Maths** menu label to select the corresponding type. Tap or rotate the knob (pressing the right arrow key will locate the cursor to the right of the interface) to select the desired waveform (the selected waveform is highlighted). The waveforms under the **Common** menu label are most frequently selected ones by users. At most, 8 waveforms can be stored.

Table 2-2 160 Built-in Arbitrary Waveforms

| Type               | Waveform | Remarks   |
|--------------------|----------|---|
| <b>Engineering</b> |          |   |
|                    | Sinc     | Sinc function                                   |
|                    | Lorentz  | Lorentz function                                |
|                    | Log      | Logarithm function and the base is 10           |
|                    | GausPul  | Gauss pulse                                     |
|                    | NegRamp  | Negative ramp                                   |
|                    | NPulse   | Negative pulse                                  |
|                    | PPulse   | Positive pulse                                  |
|                    | SineTra  | Sine-Tra waveform                               |
|                    | SineVer  | Sine-Ver waveform                               |
|                    | StairDn  | Stair-down waveform                             |
|                    | StairUD  | Stair-up and stair-down waveform                |
|                    | StairUp  | Stair-up waveform                               |
|                    | Trapezia | Trapezia waveform                               |
|                    | AmpALT   | Gain oscillation curve                          |
|                    | AttALT   | Attenuation oscillation curve                   |
|                    | RouHalf  | RoundHalf Wave                                  |
|                    | RousPM   | RoundsPM Waveform                               |
|                    | BlaWave  | Time-velocity curve of explosive vibration      |
|                    | DampOsc  | Time-displacement curve of damped oscillation   |
|                    | SwigOsc  | Kinetic energy- time curve of swing oscillation |
|                    | Dischar  | Discharge curve of Ni-MH battery                |
|                    | Pahcur   | Current waveform of DC brushless motor          |
|                    | Combin   | Combination function                            |
|                    | SCR      | SCR firing profile                              |
|                    | Bworth   | Butterworth filter                              |
|                    | Chshev1  | Chebyshev1 filter                               |



|                |          |                                |
|----------------|----------|--------------------------------|
|                | Chshev2  | Chebyshev2 filter              |
|                | TV       | TV signal                      |
|                | Voice    | Voice signal                   |
|                | Surge    | Surge signal                   |
|                | Radar    | Radar signal                   |
|                | DualTone | Dual-tone signal               |
|                | Ripple   | Power ripple                   |
|                | Quake    | Analog quake waveform          |
|                | Gamma    | Gamma signal                   |
|                | StepResp | Step-response signal           |
|                | BandLim  | Bandwidth-limited signal       |
|                | CPulse   | C-Pulse signal                 |
|                | CWPulse  | CW pulse signal                |
|                | GateVibr | Gate self-oscillation signal   |
|                | LFMPulse | Linear FM pulse signal         |
|                | MCNoise  | Mechanical construction noise  |
|                | AM       | Sectioned sine AM signal       |
|                | FM       | Sectioned sine FM signal       |
|                | PFM      | Sectioned pulse FM signal      |
|                | PM       | Sectioned sine PM signal       |
|                | PWM      | Sectioned PWM signal           |
| <b>Medical</b> |          |                                |
|                | Cardiac  | Cardiac signal                 |
|                | EOG      | Electro-oculogram              |
|                | EEG      | Electroencephalogram           |
|                | EMG      | Electromyogram                 |
|                | Pulgram  | Pulsilogram                    |
|                | ResSpd   | Speed curve of the respiration |
|                | ECG1     | Electrocardiogram 1            |
|                | ECG2     | Electrocardiogram 2            |
|                | ECG3     | Electrocardiogram 3            |
|                | ECG4     | Electrocardiogram 4            |
|                | ECG5     | Electrocardiogram 5            |
|                | ECG6     | Electrocardiogram 6            |
|                | ECG7     | Electrocardiogram 7            |
|                | ECG8     | Electrocardiogram 8            |
|                | ECG9     | Electrocardiogram 9            |
|                | ECG10    | Electrocardiogram 10           |
|                | ECG11    | Electrocardiogram 11           |
|                | ECG12    | Electrocardiogram 12           |
|                | ECG13    | Electrocardiogram 13           |
|                | ECG14    | Electrocardiogram 14           |
|                | ECG15    | Electrocardiogram 15           |

|                 |           |   |
|-----------------|-----------|---|
|                 | LFPulse   | Waveform of the low frequency pulse electrotherapy            |
|                 | Tens1     | Waveform 1 of the nerve stimulation electrotherapy            |
|                 | Tens2     | Waveform 2 of the nerve stimulation electrotherapy            |
|                 | Tens3     | Waveform 3 of the nerve stimulation electrotherapy            |
| <b>AutoElec</b> |           |   |
|                 | Ignition  | Ignition waveform of the automotive motor                     |
|                 | SP        | Automotive starting profile with ringing                      |
|                 | VR        | Automotive supply voltage profile for resetting               |
|                 | TP1       | Automotive transients arising from disconnection              |
|                 | TP2A      | Automotive transients arising from inductance in wiring       |
|                 | TP2B      | Automotive transients arising from the ignition switching off |
|                 | TP3A      | Automotive transients arising from switching                  |
|                 | TP3B      | Automotive transients arising from switching                  |
|                 | TP4       | Automotive working profile during start-up                    |
|                 | TP5A      | Automotive transients arising from cut-off of battery power   |
|                 | TP5B      | Automotive transients arising from cut-off of battery power   |
| <b>Maths</b>    |           |   |
|                 | Airy      | Airy function   |
|                 | Besseli   | Bessel functions of the first kind                            |
|                 | Bessely   | Bessel functions of the second kind                           |
|                 | Cubic     | Cubic function  |
|                 | Dirichlet | Dirichlet function  |
|                 | Erf       | Error function  |
|                 | Erfc      | Complementary error function                                  |
|                 | ErfcInv   | Inverted complementary error function                         |
|                 | ErfInv    | Inverted error function                                       |
|                 | ExpFall   | Exponential fall function                                     |
|                 | ExpRise   | Exponential rise function                                     |
|                 | HavSin    | HaverSine function  |

|          |  |
|----------|--|
| Laguerre | 4-times Laguerre polynomial                  |
| Legend   | 5-times Legend polynomial                    |
| Versiera | Versiera                                     |
| ARB_X2   | Square function                              |
| Gauss    | Gaussian distribution or normal distribution |
| Weibull  | Weibull distribution                         |
| LogNorm  | Logarithmic normal distribution              |
| Laplace  | Laplace distribution                         |
| Maxwell  | Maxwell distribution                         |
| Rayleigh | Rayleigh distribution                        |
| Cauchy   | Cauchy distribution                          |
| CosH     | Hyperbolic cosine                            |
| CosInt   | Integral cosine                              |
| Cot      | Cotangent                                    |
| CotHCon  | Concave hyperbolic cotangent                 |
| CotHPro  | Protuberant hyperbolic cotangent             |
| CscCon   | Concave cosecant                             |
| CscPro   | Protuberant cosecant                         |
| CschCon  | Concave hyperbolic cosecant                  |
| CschPro  | Protuberant hyperbolic cosecant              |
| RecipCon | Concave reciprocal                           |
| RecipPro | Protuberant reciprocal                       |
| SecCon   | Concave secant                               |
| SecPro   | Protuberant secant                           |
| SecH     | Hyperbolic secant                            |
| SinH     | Hyperbolic sine                              |
| SinInt   | Integral sine                                |
| Sqrt     | Square root                                  |
| Tan      | Tangent                                      |
| TanH     | Hyperbolic tangent                           |
| AbsSine  | Absolute value of sine                       |
| AbsSinH  | Absolute value of half sine                  |
| ACos     | Arc cosine                                   |
| ACosH    | Arc hyperbolic cosine                        |
| ACotCon  | Concave arc cotangent                        |
| ACotPro  | Protuberant arc cotangent                    |
| ACotHCon | Concave arc hyperbolic cotangent             |
| ACotHPro | Protuberant arc hyperbolic cotangent         |
| ACscCon  | Concave arc cosecant                         |
| ACscPro  | Protuberant arc cosecant                     |
| ACschCon | Concave arc hyperbolic cosecant              |
| ACschPro | Protuberant arc hyperbolic cosecant          |
| ASecCon  | Concave arc secant                           |

|          |   |
|----------|---|
| ASecPro  | Protuberant arc secant                                |
| ASecH    | Arc hyperbolic secant                                 |
| ASin     | Arc Sinc  |
| ASinH    | Arc hyperbolic sine                                   |
| ATan     | Arc tangent   |
| ATanH    | Arc hyperbolic tangent                                |
| Bartlett | Bartlett window                                       |
| BarWin   | Modified Bartlett-Hann window                         |
| Blkman   | Blackman window                                       |
| BlkmanH  | Blackman-Harris window                                |
| BohWin   | Bohman window   |
| Boxcar   | Rectangular window                                    |
| ChebWin  | Chebyshev window                                      |
| FlatWin  | Flat Top weighted window                              |
| Ham      | Hamming window  |
| Hanning  | Hanning window  |
| Kaiser   | Kaiser window   |
| NutWin   | Nuttall-defined minimum 4-term Blackman-Harris window |
| ParWin   | Parzen window   |
| TayWin   | Taylor window   |
| Triang   | Triangle window (Fejer window)                        |
| TukWin   | Tukey (tapered cosine) window                         |

## To Set Parameters

After selecting the desired waveform, you are automatically directed to the waveform parameter setting interface.

1. **Freq/Period:** sets the output frequency/period of the arbitrary waveform.
2. **Ampl/HighL:** sets the output amplitude/high level of the arbitrary waveform.
3. **Offset/LowL:** sets the output offset/low level of the arbitrary waveform.
4. **Phase:** sets the output start phase of the arbitrary waveform.

Please refer to "**To Output Basic Waveform**" to configure the parameters and output for the channel.

## To Output Harmonic

DG800 can be used as a harmonic generator to output harmonic with specified order, amplitude and phase. It is usually used in the test of harmonic detector device or harmonic filter device. This section introduces how to configure the generator to output harmonic.

### Harmonic Overview

According to Fourier transform, time domain waveform is the superposition of a series of sine waveforms, as shown in the equation below:

$$f(t) = A_1 \sin(2\pi f_1 t + \varphi_1) + A_2 \sin(2\pi f_2 t + \varphi_2) + A_3 \sin(2\pi f_3 t + \varphi_3) + \dots$$

Generally, component with  $f_1$  frequency is called fundamental waveform,  $f_1$  is the fundamental waveform frequency,  $A_1$  is the fundamental waveform amplitude, and  $\varphi_1$  is the fundamental waveform phase. The frequencies of the other components (called harmonics) are all integral multiple of the fundamental waveform frequency. Components whose frequencies are odd multiples of the fundamental waveform frequency are called odd harmonics, and components whose frequencies are even multiples of the fundamental waveform frequency are called even harmonics.

At most, 8th harmonic can be output by DG800. After selecting CH1 or CH2, press **Menu** → **Continuous** → "Harm" to enter the harmonic setting menu. You can set fundamental waveform parameters, select the type of output harmonic, specify the highest order of harmonic, and set the amplitude and phase of each order of harmonic.

After completing the harmonic parameters setting, press **Output1**, and the backlight turns on. The instrument outputs the specified harmonic from the corresponding output terminal. For details, refer to descriptions in "**To Enable Channel Output**".

## To Set Fundamental Waveform Parameters

DG800 allows users to set various fundamental waveform parameters such as frequency, period, amplitude, DC offset voltage, high level, low level, and start phase. It also supports align phase operation. To set the above fundamental waveform parameters, refer to descriptions in "**To Output Basic Waveform**".

## To Select Harmonic Type

DG800 can output even harmonic, odd harmonic, both harmonics, and user-defined order of harmonic. After entering the harmonic setting interface, tap the **Type** parameter selection field to select the desired harmonic type.

1. **Even:** outputs fundamental waveform and even harmonics.
2. **Odd:** outputs fundamental waveform and odd harmonics.
3. **Both:** outputs fundamental waveform and all the harmonics in order.
4. **User:** outputs the user-defined orders of harmonics. The highest order is 8.

8 bits binary data are used to represent the output status of the 8 orders of harmonics respectively. Wherein, 1 represents enabling the output of the corresponding harmonic, and 0 represents disabling the output of the corresponding harmonic. You only need to tap the **User** parameter input field, and then modify the value of each data bit by using the numeric keypad (note that the leftmost bit representing fundamental waveform is always X and cannot be modified). For example, if you set the 8 bits data to X001 0001, it indicates that the fundamental waveform, 4th and 8th orders of harmonics are output.

**Note:** The actually output harmonics is determined by the currently specified harmonic order and harmonic type.

## To Set Harmonic Order

The highest order of harmonic output from DG800 cannot be greater than the specified value.

After entering the harmonic setting interface, tap the **Count** parameter selection field to input a value with numeric keypad.

- The range is limited by the maximum output frequency of the instrument and current fundamental waveform frequency.
- Range: **2** to **maximum output frequency ÷ fundamental waveform**

- **frequency**, an integer.
- The maximum is 8.

You can also use the arrow keys and the knob to set the parameter value: press down the knob to enter the editing mode, use the arrow keys to move the cursor to select the digit to be edited, and then rotate the knob to modify the value. Besides, you can use the knob to switch between different parameters.

## To Select Harmonic Amplitude

After entering the harmonic setting interface, tap the **Harm Ampl** parameter input field to set the amplitude of each order of harmonic.

- 1) **No.:** selects the sequence number of the harmonic to be set.
- 2) **Harm Ampl:** sets the amplitude of the specified order of harmonic. Use the numeric keypad to input the amplitude value, and then select the desired unit. Tap "Ok". The amplitude units available are Vpp, mVpp, Vrms, mVrms, and dBm (invalid in HighZ).

## To Set Harmonic Phase



After entering the harmonic setting interface, tap the **Harm Phase** parameter input field to set the phase of each order of harmonic.

1. **No.:** selects the sequence number of the harmonic to be set.
2. **Harm Phase:** sets the phase of the specified order of harmonic. Use the numeric keypad to input the phase value, and then select the desired unit "°". Tap "Ok".

## Example: To Output Harmonic

This section introduces how to output 2th order of harmonic (harmonic amplitude: 2 Vpp, harmonic phase: 30°) and 4th orders of harmonic (harmonic amplitude: 1 Vpp, harmonic phase: 50°) from the **[CH1]** connector.

1. **Select the output channel:** Press **Output1** on the front panel or tap the channel output configuration status bar  to select CH1. At this time, the channel is indicated in red in the status bar.

2. **Set fundamental waveform parameters:** In this example, various parameters of the fundamental waveform take the default values. You can also refer to descriptions in "**To Output Basic Waveform**" to set various fundamental waveform parameters such as frequency/period, amplitude/high level, offset/low level, and start phase.
3. **Enable harmonic function:** Press **Menu** on the front panel, and then the waveform selection interface is displayed. Tap **Continuous** and then select the **"Harm"** icon to go to the harmonic parameter setting interface automatically.
4. **Set harmonic count:** In the harmonic parameter setting interface, tap the **Count** parameter input field to input a value 5 with pop-up numeric keypad. Tap **"Ok"**.
5. **Select the harmonic type:** In the harmonic parameter setting interface, tap the **Type** parameter selection field to select the desired even harmonic.
6. **Set harmonic amplitude:** In the harmonic parameter setting menu, set the amplitude of 2th and 4th orders of harmonic.
  - 1) Tap the **No.** parameter input field to input 2 with the pop-up numeric keypad, and then tap **"Ok"**.
  - 2) Tap the **Harm Ampl** parameter input field to input 2 with the pop-up numeric keypad, select the unit "Vpp". Then tap **"Ok"**.
  - 3) Refer to Step 1 and Step 2 to set the amplitude of the 4th order harmonic to 1 Vpp.
7. **Set harmonic phase:** In the harmonic parameter setting menu, set the phases of 2th and 4th orders of harmonic in sequence.
  - 1) Tap the **No.** parameter input field to input 2 with the pop-up numeric keypad, and then tap **"Ok"**.
  - 2) Tap the **Harm Phase** parameter input field to input 30 with the pop-up numeric keypad, select the unit "°". Then tap **"Ok"**.
  - 3) Refer to Step 1 and Step 2 to set the phase of the 4th order harmonic to 50°.
8. **Enable channel output:** Press **Output1**, and the backlight turns on. Also, you can tap the channel output configuration status bar  to enable the channel output. Then, the channel status is highlighted (i.g. ) , and the fundamental waveform, 2th and 4th order of harmonics are output from the **[CH1]** connector based on the current configurations.
9. **Observe the output waveform:** Connect the **[CH1]** connector of DG800 to the oscilloscope by using the BNC cable. The waveform is as shown in the figure below.



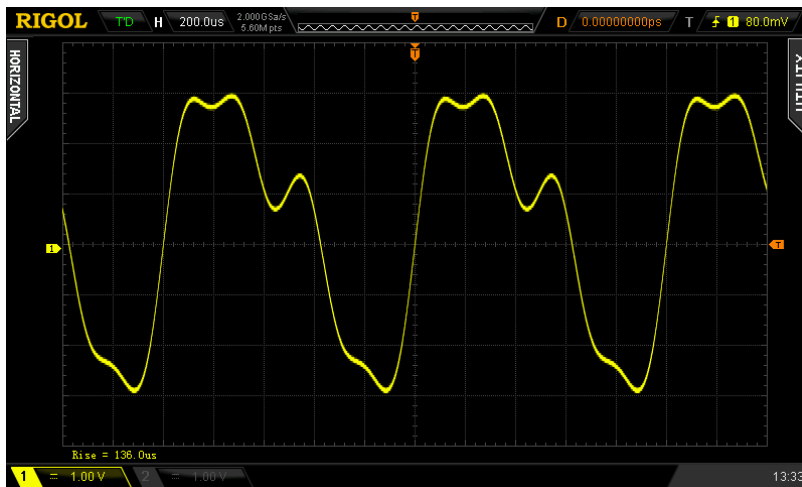

Figure 2-5 Harmonic

## DC

DG800 can output DC signal with amplitude range from -10 V to 10 V (HighZ) or from -5 V to 5 V (when the load is 50  $\Omega$ ). The figure below shows a sketch of the DC signal. Press **Menu** → **Continuous** → "DC" to select the DC signal.

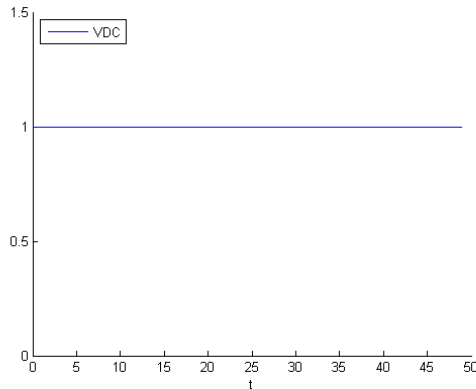

Figure 2-6 Sketch of DC signal

Tap the **Offset** parameter input field to input the desired offset value with the numeric keypad, then select the unit. Tap **Ok**.

You can also use the arrow keys and the knob to set the parameter value: press down the knob to enter the editing mode, use the arrow keys to move the cursor to select the digit to be edited, and then rotate the knob to modify the value.

## To Output Dual-tone Waveform

Press **Menu** → **Continuous** → "Dualtone" to enter the dual-tone signal parameter setting interface.

1. **Freq1/CentFreq:** sets the output frequency/period of Signal 1 in the dual-tone signal.
2. **Freq2/OffsFreq:** sets the output frequency/period of Signal 2 in the dual-tone signal.
3. **Ampl/HighL:** sets the output amplitude/high level of the dual-tone signal.
4. **Offset/LowL:** sets the output offset/low level of the dual-tone signal.

Please refer to "**To Output Basic Waveform**" to configure the parameters and output for the channel.

## To Output Advanced Waveform

DG800 provides three advanced waveforms: PRBS, RS232, and Sequence.

**Note:** When one channel is set to one of the advanced waveforms, the other channel will automatically switch to the set advanced waveform from other waveform.

### PRBS

A PRBS is generated by a linear-feedback shift register (LFSR), as shown below.

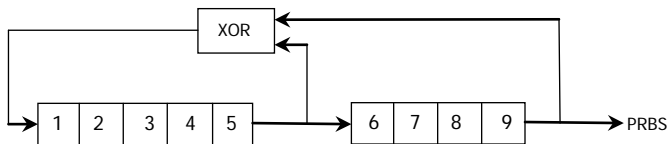

An LFSR is specified by the number of stages it contains ( $L$ ) and which stages (taps) feed the exclusive-or (XOR) gates in its feedback network. The PRBS output is taken from the last stage. After selecting proper taps, an  $L$ -stage LFSR produces a repetitive PRBS of length  $2^L - 1$ . The clock frequency of LFSR determines the "bit rate" of PRBS.

Press **Menu** → **Advanced** → **"PRBS"** to open the PRBS parameter setting interface.

1. **Bit Rate:** sets the output bit rate of the PRBS waveform.
2. **Ampl/HighL:** sets the output amplitude/high level of the PRBS waveform.
3. **Offset/LowL:** sets the output offset/low level of the PRBS waveform.
4. **Data:** selects the data type of the PRBS waveform to PRBS7, PRBS9, PRBS11, resulting in sequences of 127, 511, and 2047 bits in length. By default, it is PRBS7.

Please refer to **"To Output Basic Waveform"** to configure the parameters and output for the channel.

## RS232

In RS232 serial protocol, a character is transmitted as a frame of data. The frame consists of 1 start bit, 5-8 data bits, 0-1 check bit, and 1-2 stop bits. Its format diagram is as shown in the figure below. RS232 uses "Negative Logic", i.g. high level is logic "0" and low level is logic "1".

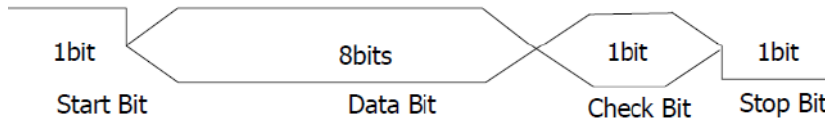

Press **Menu** → **Advanced** → **"RS232"** to open the RS232 waveform parameter setting interface.

1. **Baud Rate:** sets the output baud rate of RS232 waveform.
2. **Ampl/HighL:** sets the output amplitude/high level of RS232 waveform.
3. **Offset/LowL:** sets the output offset/low level of RS232 waveform.
4. **Data Bits:** sets the data bits of RS232 waveform to 5, 6, 7, or 8.
5. **Stop Bits:** sets the stop bits of RS232 waveform to "1", "1.5", or "2".
6. **Parity Bit:** sets the check bit of RS232 waveform to "Odd", "Even", or "None".
7. **Data:** sets the data of RS232 waveform. The available value is from 0 to 255.

Please refer to **"To Output Basic Waveform"** to configure the parameters and output for the channel.

## Sequence

You can self-define the sequence, and the edited waveforms can be stored in the internal or external memory of the instrument in "\*.SEQ" format.

Press **Menu** → **Advanced** → "Sequence" to open the Sequence parameter setting interface. Tap the icon  at the upper-right corner of the interface to enter the Sequence editing interface, as shown in the figure below.



Figure 2-7 Sequence Editing Interface

**No.:** indicates the serial number represented by "n". The available range of "n" is from 1 to 8.

**Wave:** selects the waveform that corresponds to the current No.

**Period:** sets the number of cycles of the currently selected waveform in "n".

Tap **Ok** to confirm the current editing and go back to the Sequence parameter setting interface. You can preview the currently set waveforms in the right section of the interface and set the waveform parameters at the left section of the interface.

Tap **Store** to save the currently edited Sequence waveform to the internal non-volatile memory (Disk C) or the external memory (Disk D, when a USB storage device is inserted).

1. **Filter:** selects the filter type of Sequence.
  - Smooth: The frequency response is relatively wide and flat. The edge time is fast but the sharp transitions will have overshoot and ringing.
  - Step: The sharp transitions are relatively ideal, with a narrower frequency bandwidth and the edge time is relatively slow.
  - Interpolation: An abrupt change may occur among the output points-to-points. The edge time can be adjustable.
2. **Samp. Rate:** sets the output sample rate of Sequence.
3. **Ampl/HighL:** sets the output amplitude/high level of Sequence.
4. **Offset/LowL:** sets the output offset/low level of Sequence.

5. **Phase:** sets the output start phase of Sequence.
6. **Edge Time:** sets the edge time of Sequence.

Please refer to "**To Output Basic Waveform**" to configure the parameters and output for the channel.

## Modulation

DG800 can output modulated waveforms from a single channel or from dual channels at the same time. Modulation is the process of modifying certain parameters (e.g. amplitude, frequency, or phase) of the carrier waveform signal according to the changes of the modulating signal. The carrier waveform can be Sine, Square, Ramp, Arbitrary waveform, or Pulse (only in PWM). The modulating waveform can be from internal or external modulation source. The modulation types supported by DG800 include AM, FM, PM, ASK, FSK, PSK, and PWM.

### Amplitude Modulation (AM)

For amplitude modulation (AM), the amplitude of the carrier waveform varies with the instantaneous voltage of the modulating waveform.

#### To Select AM Modulation

Press **Menu** → **Modulation** → "AM" to enable the AM function. When **Modulation** is enabled, **Sweep** or **Burst** will be automatically disabled (if enabled currently). Tap the icon  at the upper-right corner of the interface (when Sine is selected as the carrier waveform) to view and set the parameters of the current carrier waveform.

Tap the icon  at the upper-right corner of the interface again to go back to the current modulation parameter interface.

#### To Select the Carrier Waveform

AM carrier waveform could be Sine, Square, Ramp, or Arbitrary waveform. The default is Sine.

- Press **Menu** → **Continuous** to select the desired carrier waveform.
- Pulse, Noise, Harmonic, Dual-tone, and DC could not be used as carrier waveform.

#### To Set Carrier Waveform Parameters

The different settings of various parameters (e.g. frequency, amplitude, offset, and start phase) of the carrier waveform will affect the output AM modulated waveform. For different carrier waveform shapes, the ranges of the various parameters are different (the ranges are related to the instrument model that you are using and the currently selected carrier waveform). For all carrier waveform shapes, the default values are 1 kHz frequency, 5 Vpp amplitude, 0 Vdc offset, and 0° start phase.



- When the carrier waveform currently selected is Sine, Square, or Ramp, please refer to descriptions in **"To Output Basic Waveform"** to set the parameters of the carrier waveform currently selected.
- When the carrier waveform currently selected is arbitrary waveform, please refer to descriptions in **"To Output the Arbitrary Waveform"** to set the parameters of the carrier waveform currently selected.

## To Select Modulation Source

DG800 can receive modulating waveform from the internal or external modulation source. Tap the **Source** parameter selection field to select an "Internal" or "External" modulation source.

### 1. Internal Source

When the internal modulation source is selected, tap the **Mod.Wave** parameter selection field to select Sine, Square, Triangle, UpRamp, DnRamp, Noise, or Arb as modulating waveform. By default, Sine is selected.

- Square: 50% duty cycle.
- Triangle: 50% symmetry.
- UpRamp: 100% symmetry.
- DnRamp: 0% symmetry.
- Arb: the arbitrary waveform selected for the current channel.

**Note:** Noise can be used as the modulating waveform but cannot be used as carrier waveform.

### 2. External Source

When the external modulation source is selected, **Mod.Wave** and **Mod.Freq** will be grayed out and disabled. The generator receives the external modulating signal from the rear-panel **[CH1/Sync/Ext Mod/Trig/FSK]** connector. At this time, amplitude of the modulated waveform is controlled by the  $\pm 5$  V signal level of the connector. For example, if the modulation depth is set to 100%, the output amplitude will be the maximum when the modulating signal is +5 V and the minimum when the modulating signal is -5 V.

**Key Points:**

**How to realize the intermodulation between dual channels? The following example takes the output signal of CH2 as the modulating waveform.**

1. Connect the CH2 output terminal to the rear-panel **[CH1/Sync/Ext Mod/Trig/FSK]** connector by using the dual BNC cable.
2. Select CH1, then press **Menu** → **Modulation** to select the desired modulation type and set the corresponding parameters. After that, select the external modulation source.
3. Select CH2 and set the desired modulating waveform and the corresponding parameters.
4. Press **Output1** to enable the output of CH1.

## To Set Modulating Waveform Frequency

When the internal modulation source is selected, tap the **Mod.Freq** parameter input field, use the numeric keypad to input the modulating waveform frequency.

- You can also use the arrow keys and the knob to input a desired frequency value.
- The modulating waveform frequency ranges from 2 mHz to 1 MHz, and the default value is 100 Hz.

**Note:** When the external modulation source is selected, this menu will be grayed out and disabled.

## To Set the Modulation Depth

Modulation depth indicates the amplitude variation. It is expressed in percentage. The AM modulation depth ranges from 0% to 120%. Tap the **Mod.Depth** parameter input field to set the AM modulation depth.

- At 0% depth, the output amplitude is half of the carrier waveform amplitude.
- At 100% depth, the output amplitude is equal to carrier waveform amplitude.
- At >100% depth, the output amplitude of the instrument will not exceed 10 V<sub>pp</sub> (into a 50 Ω load).

When the external modulation source is selected, the output amplitude of the instrument is controlled by the ±5 V signal level of the rear-panel **[CH1/Sync/Ext Mod/Trig/FSK]** connector. For example, if the modulation depth is set to 100%, the output amplitude will be the maximum when the modulating signal is +5 V and the minimum when the modulating signal is -5 V.



## Carrier Waveform Suppression

DG800 supports two types of amplitude modulation: normal amplitude modulation and double sideband suppressed carrier (DSSC) amplitude modulation. In the normal amplitude modulation, the modulated waveform contains carrier waveform components. Because carrier waveform components carry no information, the modulation is less efficient. In order to improve the modulation efficiency, the carrier waveform components are suppressed on the basis of the normal amplitude modulation. At this time, the modulated waveforms all carry information. This method is called double sideband suppressed carrier modulation. By default, DG800 selects the normal amplitude modulation. Tap the **DSSC** parameter selection field to select "On" to enable the double sideband suppressed carrier modulation.

## Frequency Modulation (FM)

For frequency modulation (FM), the frequency of the carrier waveform varies with the instantaneous voltage of the modulating waveform.

### To Select FM Modulation

Press **Menu** → **Modulation** → "FM" to enable the FM function. When **Modulation** is enabled, **Sweep** or **Burst** will be automatically disabled (if enabled currently). Tap the icon  at the upper-right corner of the interface (when Sine is selected as the carrier waveform) to view and set the parameters of the current carrier waveform. Tap the icon  at the upper-right corner of the interface again to go back to the current modulation parameter interface.

### To Select the Carrier Waveform

FM carrier waveform could be Sine, Square, Ramp, or Arbitrary waveform. The default is Sine.

- Press **Menu** → **Continuous** to select the desired carrier waveform.
- Pulse, Noise, Harmonic, Dual-tone, and DC could not be used as carrier waveform.

### To Set Carrier Waveform Parameters

The different settings of various parameters (e.g. frequency, amplitude, offset, and start phase) of the carrier waveform will affect the output FM modulated waveform. For different carrier waveform shapes, the ranges of the various parameters are different (the ranges are related to the instrument model that you are using and the currently selected carrier waveform). For all carrier waveform shapes, the default values are 1 kHz frequency, 5 Vpp amplitude, 0 Vdc offset, and 0° start phase.

- When the carrier waveform currently selected is Sine, Square, or Ramp, please refer to descriptions in "**To Output Basic Waveform**" to set the parameters of the carrier waveform currently selected.
- When the carrier waveform currently selected is arbitrary waveform, please refer to descriptions in "**To Output the Arbitrary Waveform**" to set the parameters of the carrier waveform currently selected.

## To Select Modulation Source

DG800 can receive modulating waveform from the internal or external modulation source. Tap the **Source** parameter selection field to select an "Internal" or "External" modulation source.

### 1. Internal Source

When internal modulation source is selected, tap the **Mod.Wave** parameter selection field to select Sine, Square, Triangle, UpRamp, DnRamp, Noise, or Arb as modulating waveform. By default, Sine is selected.

- Square: 50% duty cycle.
- Triangle: 50% symmetry.
- UpRamp: 100% symmetry.
- DnRamp: 0% symmetry.
- Arb: the arbitrary waveform selected for the current channel.

**Note:** Noise can be used as the modulating waveform but cannot be used as carrier waveform.

### 2. External Source

When the external modulation source is selected, **Mod.Wave** and **Mod.Freq** will be grayed out and disabled. The generator receives the external modulating signal from the rear-panel **[CH1/Sync/Ext Mod/Trig/FSK]** connector. At this time, the frequency deviation of the modulated waveform is controlled by the  $\pm 5$  V signal level of the connector. For example, if the frequency deviation is set to 1 kHz, +5 V signal level corresponds to a 1 kHz increase in frequency and -5 V signal level corresponds to a 1 kHz decrease in frequency.

## To Set Modulating Waveform Frequency

When the internal modulation source is selected, tap the **Mod.Freq** parameter input field and use the numeric keypad to set the modulating waveform frequency.

- You can also use the arrow keys and the knob to input a desired frequency value.
- The modulating waveform frequency ranges from 2 mHz to 1 MHz, and the default value is 100 Hz.

**Note:** When the external modulation source is selected, this menu will be grayed out and disabled.

## To Set the Frequency Deviation

Frequency deviation indicates the variation in the modulating waveform frequency from the carrier frequency. Tap the **Freq.Dev** parameter input field to set the FM frequency deviation.

- The frequency deviation must be smaller than or equal to the carrier frequency.
- The sum of frequency deviation and carrier frequency must be smaller than or equal to the the upper limit of the current carrier frequency plus 1 kHz.

**Note:** If Sine is selected currently as the carrier waveform, the carrier amplitude will be limited at 2 Vpp when the sum of the frequency deviation and the carrier frequency is greater than the frequency upper limit of the current carrier.

When the external modulation source is selected, the frequency deviation is controlled by the  $\pm 5$  V signal level on the rear-panel **[CH1/Sync/Ext Mod/Trig/FSK]** connector. Positive signal level corresponds to frequency increase, and negative signal level corresponds to frequency decrease. Lower signal levels produce less deviation. For example, if the frequency deviation is set to 1 kHz, +5 V signal level corresponds to a 1 kHz increase in frequency and -5 V signal level corresponds to a 1 kHz decrease in frequency.

## Phase Modulation (PM)

For phase modulation (PM), the phase of the carrier waveform varies with the instantaneous voltage of the modulating waveform.

### To Select PM Modulation

Press **Menu** → **Modulation** → "PM" to enable the PM function. When **Modulation** is enabled, **Sweep** or **Burst** will be automatically disabled (if enabled currently). Tap the icon  at the upper-right corner of the interface (when Sine is selected as the carrier waveform) to view and set the parameters of the current carrier waveform.

Tap the icon  at the upper-right corner of the interface again to go back to the current modulation parameter interface.

### To Select the Carrier Waveform

PM carrier waveform could be Sine, Square, Ramp, or Arbitrary waveform. The default is Sine.

- Press **Menu** → **Continuous** to select the desired carrier waveform.
- Pulse, Noise, Harmonic, Dual-tone, and DC could not be used as carrier waveform.

### To Set Carrier Waveform Parameters

The different settings of various parameters (e.g. frequency, amplitude, and offset) of the carrier waveform will affect the output PM modulated waveform. For different carrier waveform shapes, the ranges of the various parameters are different (the ranges are related to the instrument model that you are using and the currently selected carrier waveform). For all carrier waveform shapes, the default values are 1 kHz frequency, 5 Vpp amplitude, and 0 Vdc offset.

- When the carrier waveform currently selected is Sine, Square, or Ramp, please refer to descriptions in "**To Output Basic Waveform**" to set the parameters of the carrier waveform currently selected.
- When the carrier waveform currently selected is arbitrary waveform, please refer to descriptions in "**To Output the Arbitrary Waveform**" to set the parameters of the carrier waveform currently selected.

**Note:** After the PM function is enabled, the start phase of the carrier waveform cannot be set.

## To Select Modulation Source

DG800 can receive modulating waveform from the internal or external modulation source. Tap the **Source** parameter selection field to select an "Internal" or "External" modulation source.

### 1. Internal Source

When internal modulation source is selected, tap the **Mod.Wave** parameter selection field to select Sine, Square, Triangle, UpRamp, DnRamp, Noise, or Arb as modulating waveform. By default, Sine is selected.

- Square: 50% duty cycle.
- Triangle: 50% symmetry.
- UpRamp: 100% symmetry.
- DnRamp: 0% symmetry.
- Arb: the arbitrary waveform selected for the current channel.

**Note:** Noise can be used as the modulating waveform but cannot be used as carrier waveform.

### 2. External Source

When the external modulation source is selected, **Mod.Wave** and **Mod.Freq** will be grayed out and disabled. The generator receives the external modulating signal from the rear-panel **[CH1/Sync/Ext Mod/Trig/FSK]** connector. At this time, the phase deviation of the modulated waveform is controlled by the  $\pm 5$  V signal level of the connector. For example, if the phase deviation is set to  $180^\circ$ , +5 V signal level corresponds to a  $180^\circ$  phase variation. The lower external signal levels produce less deviation.

## To Set Modulating Waveform Frequency

When the internal modulation source is selected, tap the **Mod.Freq** parameter input field and use the numeric keypad to set the modulating waveform frequency.

- You can also use the arrow keys and the knob to input a desired frequency value.
- The modulating waveform frequency ranges from 2 mHz to 1 MHz, and the default value is 100 Hz.

**Note:** When the external modulation source is selected, this menu will be grayed out and disabled.



## To Set Phase Deviation

Phase deviation indicates the deviation of the modulating waveform phase from the carrier waveform phase. Tap the **Phas.Dev** parameter input field and use the numeric keypad to set the PM phase deviation.



- You can also use the arrow keys and the knob to input a desired phase value.
- The setting range of the phase deviation is from 0° to 360°, and the default is 90°.

When the external modulation source is selected, the phase deviation is controlled by the  $\pm 5$  V signal level on the rear-panel **[CH1/Sync/Ext Mod/Trig/FSK]** connector. For example, if the phase deviation is set to 180°, +5 V signal level corresponds to a 180° phase variation. The lower external signal levels produce less deviation.

## Amplitude Shift Keying (ASK)

When using ASK (Amplitude Shift Keying), you can configure the generator to "shift" its output amplitude between two preset amplitude values ("carrier amplitude" and "modulating amplitude").

### To Select ASK Modulation

Press **Menu** → **Modulation** → "ASK" to enable the ASK function. When **Modulation** is enabled, **Sweep** or **Burst** will be automatically disabled (if enabled currently). Tap the icon  at the upper-right corner of the interface (when Sine is selected as the carrier waveform) to view and set the parameters of the current carrier waveform. Tap the icon  at the upper-right corner of the interface again to go back to the current modulation parameter interface.

### To Select the Carrier Waveform

ASK carrier waveform could be Sine, Square, Ramp, or Arbitrary waveform. The default is Sine.

- Press **Menu** → **Continuous** to select the desired carrier waveform.
- Pulse, Noise, Harmonic, Dual-tone, and DC could not be used as carrier waveform.

### To Set Carrier Waveform Parameters

The different settings of various parameters (e.g. frequency, amplitude, offset, and start phase) of the carrier waveform will affect the output ASK modulated waveform. For different carrier waveform shapes, the ranges of the various parameters are different (the ranges are related to the instrument model that you are using and the currently selected carrier waveform). For all carrier waveform shapes, the default values are 1 kHz frequency, 5 Vpp amplitude, 0 Vdc offset, and 0° start phase.

- When the carrier waveform currently selected is Sine, Square, or Ramp, please refer to descriptions in "**To Output Basic Waveform**" to set the parameters of the carrier waveform currently selected.
- When the carrier waveform currently selected is arbitrary waveform, please refer to descriptions in "**To Output the Arbitrary Waveform**" to set the parameters of the carrier waveform currently selected.

## To Select Modulation Source

Tap the **Source** parameter selection field to select an "Internal" or "External" modulation source.

### 1. Internal Source

When the internal source is selected, the modulating waveform is set as a Square with 50% duty cycle. At this time, the rate at which the output amplitude "shifts" between "carrier amplitude" and "modulating amplitude" is determined by the modulation rate.

### 2. External Source

When the external source is selected, the generator receives the external modulating signal from the rear-panel **[CH1/Sync/Ext Mod/Trig/FSK]** connector.

**Note:** The **[CH1/Sync/Ext Mod/Trig/FSK]** connector controlling ASK modulation externally is different from controlling AM/FM/PM modulations externally. While controlling the ASK modulation, you can set the polarity.

## To Set Modulating Rate

When the internal source is selected, tap the **Mod.Rate** parameter input field and use the numeric keypad to set the rate at which the output amplitude shifts between "carrier amplitude" and "modulating amplitude".

- You can also use the arrow keys and the knob to input a desired frequency value.
- The frequency range is from 2 mHz to 1 MHz, and the default is 100 Hz.

**Note:** When the external modulation source is selected, this menu will be grayed out and disabled.

## To Set the Modulation Amplitude

Tap the **Mod.Ampl** parameter input field and use the numeric keypad to set the modulation amplitude.

- You can also use the arrow keys and the knob to input a desired amplitude value.
- The range of amplitude (HighZ) is from 0 to 10 Vpp, and the default is 2 Vpp.

## To Set the Modulation Polarity

Tap the **Polarity** parameter selection field to select "Positive" or "Negative" polarity of the modulating waveform to control the output amplitude.



In the internal modulation, set the polarity to "Positive", and the generator will output an amplitude whichever is smaller between the carrier amplitude and modulating amplitude when the modulating waveform is a logic low level. It will output an amplitude whichever is greater between the carrier amplitude and modulating amplitude when the modulating waveform is a logic high level. The situation is the opposite when the polarity is set to "Negative".

In the external modulation, set the polarity to "Positive", and the generator will output an amplitude whichever is smaller between the carrier amplitude and modulating amplitude when the external input signal is a logic low level. It will output an amplitude whichever is greater between the carrier amplitude and the modulating amplitude when the external input signal is a logic high level. The situation is the opposite when the polarity is set to "Negative".

## Frequency Shift Keying (FSK)

When using FSK (Frequency Shift Keying), you can configure the generator to "shift" its output frequency between two preset frequency values ("carrier amplitude" and "hop frequency").

### To Select FSK Modulation

Press **Menu** → **Modulation** → "FSK" to enable the FSK function. When **Modulation** is enabled, **Sweep** or **Burst** will be automatically disabled (if enabled currently). Tap the icon  at the upper-right corner of the interface (when Sine is selected as the carrier waveform) to view and set the parameters of the current carrier waveform. Tap the icon  at the upper-right corner of the interface again to go back to the current modulation parameter interface.

### To Select the Carrier Waveform

FSK carrier waveform could be Sine, Square, Ramp, or Arbitrary waveform. The default is Sine.

- Press **Menu** → **Continuous** to select the desired carrier waveform.
- Pulse, Noise, Harmonic, Dual-tone, and DC could not be used as carrier waveform.

### To Set Carrier Waveform Parameters

The different settings of various parameters (e.g. frequency, amplitude, offset, and start phase) of the carrier waveform will affect the output FSK modulated waveform. For different carrier waveform shapes, the ranges of the various parameters are different (the ranges are related to the instrument model that you are using and the currently selected carrier waveform). For all carrier waveform shapes, the default values are 1 kHz frequency, 5 V<sub>pp</sub> amplitude, 0 V<sub>dc</sub> offset, and 0° start phase.

- When the carrier waveform currently selected is Sine, Square, or Ramp, please refer to descriptions in "**To Output Basic Waveform**" to set the parameters of the carrier waveform currently selected.
- When the carrier waveform currently selected is arbitrary waveform, please refer to descriptions in "**To Output the Arbitrary Waveform**" to set the parameters of the carrier waveform currently selected.

## To Select Modulation Source

Tap the **Source** parameter selection field to select an "Internal" or "External" modulation source.

### 1. Internal Source

When the internal source is selected, the modulating waveform is set as a Square with 50% duty cycle. At this time, the rate at which the output frequency "shifts" between "carrier frequency" and "hop frequency" is determined by the modulation rate.

### 2. External Source

When the external source is selected, the generator receives the external modulating signal from the rear-panel **[CH1/Sync/Ext Mod/Trig/FSK]** connector.

**Note:** The **[CH1/Sync/Ext Mod/Trig/FSK]** connector controlling ASK modulation externally is different from controlling AM/FM/PM modulations externally. While controlling the FSK modulation, you can set the polarity.

## To Set Modulating Rate

When the internal source is selected, tap the **Mod.Rate** parameter input field and use the numeric keypad to set the rate at which the output frequency shifts between "carrier frequency" and "hop frequency".

- You can also use the arrow keys and the knob to input a desired frequency value.
- The frequency range is from 2 mHz to 1 MHz, and the default is 100 Hz.

**Note:** When the external modulation source is selected, this menu will be grayed out and disabled.

## To Set Hop Frequency

Hop frequency indicates the frequency of the modulating waveform. The range of the hop frequency is determined by the currently selected carrier waveform. Tap the **Hop Freq** parameter input field and use the numeric keypad to input a desired frequency value. You can also use the arrow keys and the knob to input a desired frequency value.

- Sine: 1  $\mu$ Hz to 35 MHz
- Square: 1  $\mu$ Hz to 10 MHz
- Ramp: 1  $\mu$ Hz to 1 MHz
- Arb: 1  $\mu$ Hz to 10 MHz

## To Set the Modulation Polarity

Tap the **Polarity** parameter selection field to select "Positive" or "Negative" polarity of the modulating waveform to control the output frequency.



In the internal modulation, set the polarity to "Positive", and the generator will output the carrier frequency when the modulating waveform amplitude is a logic low level. It will output the hop frequency when the modulating waveform amplitude is a logic high level. The situation is the opposite when the polarity is set to "Negative".

In the external modulation, set the polarity to "Positive", and the generator will output the carrier frequency when the external input signal is a logic low level. It will output the hop frequency when the external input signal is a logic high level. The situation is the opposite when the polarity is set to "Negative".

## Phase Shift Keying (PSK)

When using PSK (Phase Shift Keying), you can configure the generator to "shift" its output phase between two preset phase values ("carrier phase" and "modulating phase").

### To Select PSK Modulation

Press **Menu** → **Modulation** → "PSK" to enable the PSK function. When **Modulation** is enabled, **Sweep** or **Burst** will be automatically disabled (if enabled currently). Tap the icon  at the upper-right corner of the interface (when Sine is selected as the carrier waveform) to view and set the parameters of the current carrier waveform. Tap the icon  at the upper-right corner of the interface again to go back to the current modulation parameter interface.

### To Select the Carrier Waveform

PSK carrier waveform could be Sine, Square, Ramp, or Arbitrary waveform. The default is Sine.

- Press **Menu** → **Continuous** to select the desired carrier waveform.
- Pulse, Noise, Harmonic, Dual-tone, and DC could not be used as carrier waveform.

### To Set Carrier Waveform Parameters

The different settings of various parameters (e.g. frequency, amplitude, offset, and start phase) of the carrier waveform will affect the output PSK modulated waveform. For different carrier waveform shapes, the ranges of the various parameters are different (the ranges are related to the instrument model that you are using and the currently selected carrier waveform). For all carrier waveform shapes, the default values are 1 kHz frequency, 5 V<sub>pp</sub> amplitude, 0 V<sub>dc</sub> offset, and 0° start phase.

- When the carrier waveform currently selected is Sine, Square, or Ramp, please refer to descriptions in "**To Output Basic Waveform**" to set the parameters of the carrier waveform currently selected.
- When the carrier waveform currently selected is arbitrary waveform, please refer to descriptions in "**To Output the Arbitrary Waveform**" to set the parameters of the carrier waveform currently selected.



## To Select Modulation Source

Tap the **Source** parameter selection field to select an "Internal" or "External" modulation source.

### 1. Internal Source

When the internal source is selected, the modulating waveform is set as a Square with 50% duty cycle. At this time, the rate at which the output phase "shifts" between "carrier phase" and "modulating phase" is determined by the modulation rate.

### 2. External Source

When the external source is selected, the generator receives the external modulating signal from the rear-panel **[CH1/Sync/Ext Mod/Trig/FSK]** connector.

**Note:** The **[CH1/Sync/Ext Mod/Trig/FSK]** connector controlling PSK modulation externally is different from controlling AM/FM/PM modulations externally. While controlling the PSK modulation, you can set the polarity.

## To Set Modulating Rate

When the internal source is selected, tap the **Mod.Rate** parameter input field and use the numeric keypad to set the rate at which the output phase shifts between "carrier phase" and "modulating phase".

- You can also use the arrow keys and the knob to input a desired frequency value.
- The frequency range is from 2 mHz to 1 MHz, and the default is 100 Hz.

**Note:** When the external modulation source is selected, this menu will be grayed out and disabled.

## To Set Modulating Phase

Modulating phase indicates the phase of the modulating waveform. Tap the **Phase** parameter input field and use the numeric keypad to set the modulation phase.

- You can also use the arrow keys and the knob to input a desired phase value.
- The phase range is from 0° to 360°, and the default is 180°.

## To Set Modulation Polarity

Tap the **Polarity** parameter selection field to select "Positive" or "Negative" polarity of the modulating waveform to control the output phase.



In the internal modulation, set the polarity to "Positive", and the generator will output the carrier phase when the modulating waveform amplitude is a logic low level. It will output the modulating phase when the modulating waveform amplitude is a logic high level. The situation is the opposite when the polarity is set to "Negative".

In the external modulation, set the polarity to "Positive", and the generator will output the carrier phase when the external input signal is a logic low level. It will output the modulation phase when the external input signal is a logic high level. The situation is the opposite when the polarity is set to "Negative".

## Pulse Width Modulation (PWM)

For PWM (Pulse Width Modulation), the pulse width of the carrier waveform varies with the instantaneous voltage of the modulating waveform.

### To Select PWM Modulation

PWM can only be used to modulate pulse. To select PWM modulation, first select **Pulse**, then press **Menu** → **Modulation** → "PWM" to enable PWM function. Tap the icon  at the upper-right corner of the interface to view and set the parameters of the current carrier waveform. Tap the icon  at the upper-right corner of the interface again to go back to the current modulation parameter interface.

- If the "Pulse" waveform is not selected, PWM modulation is unavailable.
- When **Modulation** is enabled but the modulation type is not PWM, pressing "Pulse" will select PWM automatically.
- When **Modulation** is enabled, **Sweep** or **Burst** will be automatically disabled (if enabled currently).

### To Select the Carrier Waveform

As mentioned before, the carrier waveform of PWM can only be Pulse. To select Pulse waveform, press **Menu** → **Continuous** → "Pulse".

### To Set Carrier Waveform Parameters

The different settings of various parameters (e.g. frequency, amplitude, offset, pulse width, and duty cycle) of the Pulse waveform will affect the output PWM modulated waveform. For all the pulses, the ranges of the various parameters are different. The default values are 1 kHz frequency, 5 Vpp amplitude, 0 Vdc offset, 500  $\mu$ s pulse width, and 50% duty cycle.

Please refer to descriptions in "To Output Basic Waveform" to set the parameters of the carrier waveform.

## To Select Modulation Source

Tap the **Source** parameter selection field to select an "Internal" or "External" modulation source.

### 1. Internal Source

When internal modulation source is selected, tap the **Mod.Wave** parameter selection field to select Sine, Square, Triangle, UpRamp, DnRamp, Noise, or Arb as modulating waveform. By default, Sine is selected.

- Square: 50% duty cycle.
- Triangle: 50% symmetry.
- UpRamp: 100% symmetry.
- DnRamp: 0% symmetry.
- Arb: the arbitrary waveform selected for the current channel.

**Note:** Noise can be used as the modulating waveform but cannot be used as carrier waveform.

### 2. External Source

When the external modulation source is selected, **Mod.Wave** and **Mod.Freq** will be grayed out and disabled. The generator receives the external modulating signal from the rear-panel **[CH1/Sync/Ext Mod/Trig/FSK]** connector. At this time, the width deviation or the duty cycle deviation of the modulated waveform is controlled by the  $\pm 5$  V signal level on the connector. For example, if the width deviation is set to 10 s, the +5 V signal level corresponds to a 10 s width variation.

## To Set Modulating Waveform Frequency

When the internal modulation source is selected, tap the **Mod.Freq** parameter input field and use the numeric keypad to set the modulating waveform frequency.

- You can also use the arrow keys and the knob to input a desired frequency value.
- The modulating waveform frequency ranges from 2 mHz to 1 MHz, and the default value is 100 Hz.

**Note:** When the external modulation source is selected, this menu will be grayed out and disabled.

## To Set Width/Duty Deviation

If "Width" is currently selected in the pulse of the specified channel, "Width Dev" is displayed in the interface when the PWM modulation function is enabled; if the "Duty" is currently selected in the pulse of the specified channel, "Duty Dev" is displayed in the interface when the PWM modulation function is enabled.

Tap the **Width Dev** (or **Duty Dev**) parameter input field and use the numeric keypad to input a desired value. You can also use the arrow keys and the knob to input a desired value.

- Width deviation represents the variation of the modulated waveform pulse width relative to the original pulse width (the available units are ns,  $\mu$ s, ms, s, and ks). Width deviation cannot exceed the current pulse width.  
The width deviation is limited by the minimum pulse width and current edge time setting.
- Duty deviation represents the variation of the modulated waveform pulse duty cycle relative to the original duty cycle (expressed in %).  
Duty deviation cannot exceed the current duty cycle of the pulse.  
The duty deviation is limited by the minimum duty cycle and current edge time setting.

When the external modulation source is selected, the width deviation is controlled by the  $\pm 5$  V signal level on the rear-panel **[CH1/Sync/Ext Mod/Trig/FSK]** connector. For example, if the width deviation is set to 10 s, the +5 V signal level corresponds to a 10 s width variation.

## Sweep

DG800 can output sweep waveforms from a single channel or from dual channels at the same time. In sweep mode, the generator outputs a signal variably from the start frequency to stop frequency within the specified sweep time. DG800 supports linear, log, and step sweep modes; allows users to set start hold, stop hold, and return time; supports internal, external, or manual trigger source; and capable of generating sweep output for Sine, Square, Ramp, and Arbitrary waveform.

### To Enable the Sweep Function

Press **Menu** → **Sweep** to select "Linear", "Log", or "Step" to enable the sweep function. The **Modulation** or **Burst** function will be disabled automatically (if enabled currently). At this time, the generator will generate the sweep waveform from the corresponding channel (if enabled currently) according to the current configuration. You can also reset the sweep parameters. For details, refer to the following section.

### Sweep Type

DG800 provides Linear, Log, and Step sweep types.

#### Linear Sweep

In the linear sweep type, the output frequency of the instrument varies linearly in the way of "several Hertz per second". The variation is controlled by "Start Frequency", "Stop Frequency" and "Sweep Time".

Press **Menu** → **Sweep** → "Linear" to enable the linear sweep. A straight line is displayed on the waveform on the screen, indicating that the output frequency varies linearly.

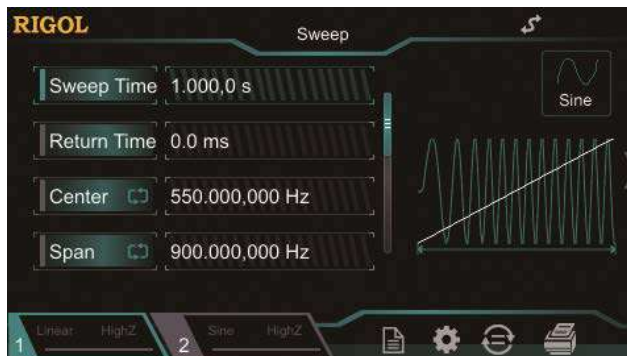

Figure 2-8 Linear Sweep

## Log Sweep

In Log Sweep type, the output frequency of the instrument varies in a logarithmic fashion, that is, the output frequency changes in the way of "octave per second" or "decade per second". The variation is controlled by "Start Frequency", "Stop Frequency", and "Sweep Time".

When Log Sweep is enabled, you can set the following parameter: start frequency  $F_{start}$ , stop frequency  $F_{stop}$ , and sweep time  $T_{sweep}$ . The function prototype of Log Sweep is:

$$F_{current} = P^T$$

$F_{current}$  is the instantaneous frequency of the current output. The parameter  $P$  and  $T$  can be expressed with the above parameter.

$$P = 10^{\lg(F_{stop} / F_{start}) / T_{sweep}}$$

$$T = t + \lg(F_{start}) / \lg(P)$$

Wherein,  $t$  is the time from the start of the sweep, and its range is from 0 to  $T_{sweep}$ .

Press **Menu** → **Sweep** → "Log" to enable the log sweep. An exponential function curve is displayed on the screen, indicating that the output frequency changes in a logarithmic mode.



Figure 2-9 Log Sweep

## Step Sweep

In Step Sweep type, the output frequency of the instrument "steps" from "Start Frequency" to "Stop Frequency" with a stepwise increase. The duration of the output signal on each frequency point is determined by "Sweep Time" and "Steps".

Press **Menu** → **Sweep** → "Step" to enable the step sweep. A step waveform is displayed on the screen, indicating that the output frequency varies with a stepwise

increase. At this point, tap to slide the screen or use the knob to page up or down. Tap the **Step** parameter input field and use the numeric keypad to set the step. You can also use the arrow keys and the knob to set the step. By default, it is 2, and its settable range is from 2 to 1024.

**Note:** In the "Linear" and "Log" sweep modes, the **Step** menu label is grayed out and disabled.



Figure 2-10 Step Sweep

## Sweep Time

When the sweep function is enabled, tap the **Sweep Time** parameter input field and use the numeric keypad to modify the sweep time. You can also use the arrow keys and the knob to modify the sweep time. By default, it is 1 s, and its settable range is from 1 ms to 500 s. The generator will restart to sweep and output from the specified "Start Frequency" after the sweep time is modified.

## Return Time

Return time indicates the time that the output signal restores from "End Freq" to "Start Freq" after the signal generator sweeps from "Start Freq" to "End Freq" and the "StopHold" time expires.

When the sweep function is enabled, tap the **Return Time** parameter input field and use the numeric keypad to modify the return time. You can also use the arrow keys and the knob to modify the return time. By default, it is 0 s, and its settable range is from 0 s to 500 s.

The generator will restart to sweep and output from the specified "Start Frequency" once the return time is modified.



## Start Frequency and Stop Frequency

Start frequency and stop frequency are the upper and lower limits of the frequency for frequency sweep. The generator always sweeps from the start frequency to the stop frequency, and then returns back to the start frequency.

- Start Frequency < Stop Frequency: the generator sweeps from low frequency to high frequency.
- Start Frequency > Stop Frequency: the generator sweeps from high frequency to low frequency.
- Start Frequency = Stop Frequency: the generator outputs with a fixed frequency.

After the sweep function is enabled, tap the **Start/Center** menu label to enable the display of "Start". Notice that the "Stop" in **Stop/Span** menu label will also be highlighted at the same time. Input the desired frequency value by using the numeric keypad, the arrow keys, or the knob. By default, the start frequency is 100 Hz, and the stop frequency is 1 kHz. Different sweep waveforms correspond to different start frequency and stop frequency ranges.

After modifying the "Start Freq" or "Stop Freq", the signal generator will restart to output from the specified "Start Freq".

## Center Frequency and Frequency Span

You can also set the frequency boundaries of frequency sweep through center frequency and frequency span.

- Center Frequency = (|Start Frequency + Stop Frequency|)/2
- Frequency Span = Stop Frequency – Start Frequency

After the sweep function is enabled, tap the **Start/Center** menu label to enable the display of "Center". At this time, the "Span" in **Stop/Span** menu label will also be highlighted at the same time. Input the desired frequency value by using the numeric keypad, the arrow keys, or the knob. By default, the center frequency is 550 Hz, and the frequency span is 900 Hz. Different sweep waveforms correspond to different center frequency and frequency span ranges. Besides, the center frequency and frequency span are mutually affected.

Define the minimum frequency of the currently selected waveform  $F_{\min}$ , the maximum frequency as  $F_{\max}$  and  $F_m = (F_{\min} + F_{\max})/2$ .

- The available range of the center frequency is from  $F_{\min}$  to  $F_{\max}$ . The parameters of different waveforms are as follows:  
Sine: 1  $\mu$ Hz to 35 MHz  
Square: 1  $\mu$ Hz to 10 MHz

Ramp: 1  $\mu$ Hz to 1 MHz

Arb: 1  $\mu$ Hz to 10 MHz

- The range of the frequency span is affected by the center frequency.  
Center frequency  $< F_m$  : the range of the frequency span is  $\pm 2 \times$  (center frequency  $- F_{\min}$ );  
Center frequency  $\geq F_m$  : the range of the frequency span is  $\pm 2 \times (F_{\max} -$  center frequency).

Take sine as an example.  $F_{\min}$  is 1  $\mu$ Hz,  $F_{\max}$  is 35 MHz, and  $F_m$  is 17.5 MHz.

If the center frequency is 550 Hz, the frequency span range is  $\pm 2 \times (550 \text{ Hz} - 1 \mu\text{Hz}) = \pm 1.099999998 \text{ kHz}$ ; if the center frequency is 20 MHz, the frequency span range is  $\pm 2 \times (35 \text{ MHz} - 20 \text{ MHz}) = \pm 30 \text{ MHz}$ .

The generator will restart to sweep from the specified "start frequency" after the "center frequency" or "frequency span" is modified.

### Tip:

In large-scale sweep, the amplitude characteristic of the output signal might change.

## Sweep Trigger Source

The trigger sources of the sweep can be Internal, External, or Manual. When the signal generator receives a trigger signal, a sweep output is generated, and then the signal generator waits for another trigger signal. After the sweep function is enabled, tap the **Source** to select "Internal", "External", or "Manual". The default is "Internal".

### 1. Internal Trigger

The generator outputs continuous sweep waveforms when the internal trigger is selected. The trigger period is determined by the specified sweep time, return time, start hold, and stop hold time.

### 2. External Trigger

In the External trigger, the signal generator receives the trigger signal input from the rear-panel **[CH1/Sync/Ext Mod/Trig/FSK]** connector. Once it receives a TTL pulse with a specified polarity, a sweep is initiated. To specify the polarity of the TTL pulse, tap the **Trig In** to select "RisEdge" or "FallEdge". By default, it is "RisEdge".

### 3. Manual Trigger

In the Manual trigger, when you press **Trig** on the front panel for one time, one sweep is immediately launched for the corresponding channel.

#### Key Points:

When "External" trigger is selected, tap the **Trig In** to select "RisEdge" or "FallEdge". The rear-panel **[CH1/Sync/Ext Mod/Trig/FSK]** connector is used as the input terminal of the external trigger signal. When "RisEdge" is selected, the instrument triggers one sweep at the rising edge of the input signal. When "FallEdge" is selected, the instrument triggers one sweep at the falling edge of the input signal.

## Marker Freq

The sync signal output from the rear-panel **[CH1/Sync/Ext Mod/Trig/FSK]** connector that corresponds to the channel on the front panel always changes from low level to high level at the start of each sweep. When the "Marker" function is disabled, the sync signal will change to low level at the center frequency point. When the "Marker" function is enabled, the sync signal changes to low level at the specified marker frequency point.

After the sweep function is enabled, tap the **Marker** menu label to select "On". Then tap the **Marker Freq** menu label, and use the numeric keypad to modify the marker frequency. You can also use the arrow keys and the knob to modify the marker frequency. The default value is 550 Hz, and the available range is limited by "Start Frequency" and "Stop Frequency".

The generator will restart to sweep and output from the specified "Start Frequency" after the mark frequency is modified.

#### Key Points:

For step sweep (the sweep points determined by the start frequency, stop frequency, and step respectively are  $f_1, f_2, \dots, f_n, f_{n+1}, \dots$ ), if the marker frequency setting is one of the sweep points values, the sync signal is TTL high level at the start of the sweep and will change to low level at the marker frequency point. If the set marker frequency is not equal to the value at the sweep point, the sync signal will change to low level at the sweep point which is closest to this marker frequency.

## Start Hold

Start hold is the duration that the output signal outputs with the "Start Frequency" after the sweep starts. After the start hold time expires, the generator will continue outputting with varied frequencies according to the current sweep type.

When the sweep function is enabled, tap the **StartHold** menu label and use the numeric keypad to modify the start hold time. You can also use the arrow keys and the knob to modify the start hold time. By default, it is 0 s, and its settable range is from 0 s to 500 s.

The generator will restart to sweep and output from the specified "Start Frequency" once the Start Hold time is changed.

## Stop Hold

Stop Hold is the duration that the output signal continues outputting with the "Stop Frequency" after the generator has swept from the "Start Frequency" to the "Stop Frequency".

When the sweep function is enabled, tap the **StopHold** menu label and use the numeric keypad to modify the stop hold time. You can also use the arrow keys and the knob to modify the stop hold time. By default, it is 0 s, and its settable range is from 0 s to 500 s.

The generator will restart to sweep and output from the specified "Start Frequency" after the Stop Hold time is modified.

## Burst

DG800 can output the waveforms with a specified number of cycles (Burst) from a single channel or from dual channels at the same time. DG800 supports control of burst output by internal, manual or external trigger source; supports three kinds of burst types, including N cycle, Infinite, and Gated. The generator can generate burst by using Sine, Square, Ramp, Pulse, Noise (only for gated burst), arbitrary waveform, PRBS, RS232, or Sequence.

### To Enable the Burst Function

Press **Menu** → **Burst** to select "N Cycle", "Infinite", or "Gated" to enable the pulse function. The **Modulation** or **Sweep** function will be disabled automatically (if enabled currently). At this time, the generator will output burst waveform from the corresponding channel (if currently turned on) according to the current configuration. You can also reset the burst function menu. Please refer to the following section for details.

### Burst Type

DG800 can output three types of bursts, including N cycle, Infinite and Gated.

Table 2-3 Relations among Burst type, Trigger Source, and Carrier Waveforms

| Type     | Trigger Source           | Carrier Waveform  |
|----------|--------------------------|---|
| N Cycle  | Internal/External/Manual | Sine, Square, Ramp, Pulse, Arbitrary Waveform, PRBS, RS232, Sequence        |
| Infinite | External/Manual          | Sine, Square, Ramp, Pulse, Arbitrary Waveform, PRBS, RS232, Sequence        |
| Gated    | External                 | Sine, Square, Ramp, Pulse, Noise, Arbitrary Waveform, PRBS, RS232, Sequence |

### N Cycle

In N Cycle mode, the generator will output waveforms with a specified number of cycles after receiving the trigger signal.

Press **Menu** → **Burst** → "N Cycle" to enable the N Cycle burst. Tap the **Cycles** menu label, then use the numeric keypad to input the number of cycles. You can also use the arrow keys and the knob to modify the number of cycles. The default is 1, and the range is from 1 to 1,000,000 (external or manual trigger) or from 1 to 500,000 (internal trigger).

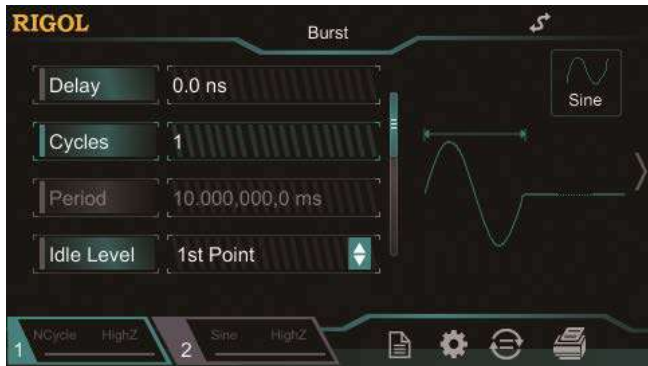

Figure 2-11 N Cycle Burst

For N cycle burst, "Internal", "External", or "Manual" trigger source could be selected. Besides, you can also set the parameters of "Period" (internal trigger), "Delay", "Trig In" (external trigger) and "Trig Out" (internal and manual trigger).

### Infinite Burst

In Infinite mode, the cycle number of the waveform is set as an infinite value. The generator outputs a continuous waveform after receiving a trigger signal.

Press **Menu** → **Burst** → "Infinite" to enable the Infinite burst. The instrument will set the trigger source to "Manual" automatically. A diagram of an infinite cycle burst will appear on the screen.



Figure 2-12 Infinite Burst

For the Infinite burst, "External" or "Manual" trigger source could be selected. Besides, users can set the parameters of "Delay", "Trig In" (external trigger), and "Trig Out" (manual trigger).

## Gated Burst

In Gated Burst Mode, the generator controls the waveform output according to the external signal level input from the rear-panel [CH1/Sync/Ext Mod/Trig/FSK] connector.

Press **Menu** → **Burst** → "Gated" to enable the gated burst. Then tap the **Polarity** menu label to select "Positive" or "Negative". Only when the gated signal is Positive or Negative, can the waveforms be output.



Figure 2-13 Gated Burst

When the gated signal is "True", the generator outputs a continuous waveform. When the gated signal is "False", the generator first completes the output of the current period and then stops. For Noise waveform, the output will stop immediately once the gated signal becomes "False".

Gated Burst could only be triggered by "External" trigger source.

## Burst Delay

Burst delay is only available for N cycle and Infinite burst mode. It is defined as the duration from the time when the generator receives the trigger signal to the time when it starts to output the N Cycle (or Infinite) burst.

Press **Menu** → **Burst** to select "N Cycle" or "Infinite", and then tap the **Delay** menu label and use the numeric keypad to input the desired delay time. You can also use the arrow keys and the knob to input a desired delay time. The range of the delay time is:  $0 \text{ s} \leq \text{delay time} \leq 100 \text{ s}$ . The default is 0 s.

## Burst Period

Burst period is only available for N cycle burst in the internal trigger. It is defined as the time from the start of a burst to the time when the next burst starts.

- Burst Period  $\geq 1 \mu\text{s} + \text{waveform period} \times \text{number of bursts}$ . Wherein, the waveform period indicates the period of burst function (e.g. Sine and Square).
- If the burst period currently set is too small, the generator will increase this period automatically to allow the output of the specified number of cycles.

Press **Menu** → **Burst** → "N**Cycle**" to enable the N Cycle burst. Tap the **Source** menu label to select "Internal", and then tap the **Period** menu label to input the desired period by using the numeric keypad. You can also use the arrow keys and the knob to input a desired period. By default, it is 10 ms, and its available range is from 1  $\mu\text{s}$  to 500 s.

## Idle Level

In burst mode, the generator outputs the carrier waveform with a specified number of cycles and then outputs a level, as shown in the figure below. The level is defined as idle level.

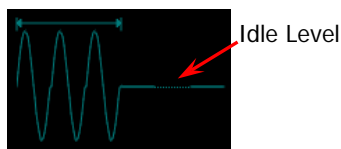

Figure 2-14 Definition of Idle Level

When Burst is enabled, tap **Idle Level** to select your desired menu to set the idle level.

1. 1st Point  
Sets the level at the first point of the carrier waveform as the idle level.
2. Top  
Sets the level at the top point of the carrier waveform as the idle level.
3. Center  
Sets the level at the center point of the carrier waveform as the idle level.
4. Bottom  
Sets the level at the bottom point of the carrier waveform as the idle level.
5. User  
Sets the level at the specified point of the carrier waveform as the idle level.



Tap the **User** menu label, and input the desired value by using the numeric keypad. You can also use the arrow keys and the knob to input a desired value. Its range is from 0 to 65535.

## Burst Trigger Source

Burst trigger source can be internal, external, or manual. The generator will generate a burst output when a trigger signal is received, and then it waits for the next trigger signal. After the burst function is enabled, tap the **Source** to select "Internal", "External", or "Manual". The default is "Internal".

### 1. Internal Trigger

When internal trigger is selected, the generator can only output N cycle burst, and the output burst frequency is determined by the "Burst Period".

Tap the **Trig Out** menu label to select "RisEdge" or "FallEdge". The rear-panel **[CH1/Sync/Ext Mod/Trig/FSK]** connector will output the trigger signal with a specified edge. If you select "Off", the trigger output is disabled.

### 2. External Trigger

When external trigger is selected, the generator can only output N cycle burst, Infinite burst, or Gated burst. The signal generator receives the trigger signal input from the rear-panel **[CH1/Sync/Ext Mod/Trig/FSK]** connector. Once it receives a TTL pulse with a specified polarity, a burst output is initiated. To specify the polarity of the TTL pulse, tap **Trig In** to select "RisEdge" or "FallEdge". By default, it is "RisEdge".

### 3. Manual Trigger

When manual trigger is selected, the generator can output N cycle burst or Infinite burst. When you press **Trig** on the front panel for one time, one burst output is immediately launched for the corresponding channel (if enabled currently).

Tap the **Trig Out** menu label to select "RisEdge" or "FallEdge". The rear-panel **[CH1/Sync/Ext Mod/Trig/FSK]** connector will output the trigger signal with a specified edge. If you select "Off", the trigger output is disabled.

## Gated Polarity

Gated polarity is only available in gated burst mode.

The instrument outputs the burst when the gated signal on the rear-panel **[CH1/Sync/Ext Mod/Trig/FSK]** connector is "High Level" or "Low Level".

Press **Menu** → **Burst** → **"Gated"** to enable the gated burst. Tap the **Polarity** to select "Positive" or "Negative", and the default is "Positive".

## Frequency Counter

DG800 provides a frequency counter which can measure various parameters (e.g. frequency, period, duty cycle, positive pulse width, and negative pulse width) of the external input signal and make statistics of measurement results. When the statistical function is enabled, the instrument calculates the maximum, minimum, average, and standard deviation of the measurement values automatically and displays the variation tendency of the measurement values in "Digital" or "Curve" mode. In addition, CH1 output can work normally while the frequency counter is making measurements.

### To Enable the Frequency Counter

Press **Counter** on the front panel (the backlight turns on) to enable the frequency counter function and enter the frequency counter setting interface.

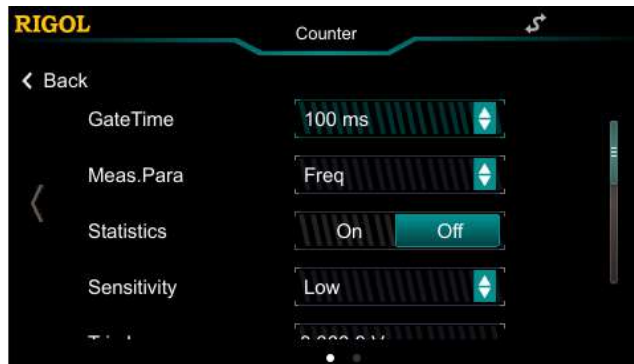

Figure 2-15 Frequency Counter Parameter Setting Interface

If the frequency counter is currently turned on and the screen displays the frequency counter interface, press **Counter** again to disable the frequency counter function. If the frequency counter is currently enabled and the screen displays interfaces other than the frequency counter interface, press **Counter** again to switch to the frequency counter interface.

**Note:** When the frequency counter is enabled, the output of CH2 will be disabled.

## To Set the Frequency Counter

### 1. Gate Time

Tap the **GateTime** parameter selection field to select the gate time for the measurement system. The default is "100ms". When "Auto" is selected, the instrument will select an appropriate gate time automatically according to the characteristics of the signal to be measured.

|        |            |
|--------|------------|
| 1 ms   | 1.048 ms   |
| 10 ms  | 8.389 ms   |
| 100 ms | 134.218 ms |
| 1 s    | 1.074 s    |
| 10 s   | 8.590 s    |
| >10 s  | >8.590 s   |

### 2. To Select the Parameters to be Measured

Tap the **Meas.Para** parameter selection field to select the type of parameter to be measured by the frequency counter. The frequency counter can measure the following parameters: frequency, period, duty cycle, positive pulse width, and negative pulse width. The default is "frequency".

### 3. Statistical Function

Tap the **Statistics** parameter selection field to enable or disable the statistical function of the frequency counter. When the statistical function is enabled, the instrument calculates the maximum, minimum, average, and standard deviation of the measurement values automatically and displays the variation tendency of the measurement values in "Digital" or "Curve" mode. Slide left the touch screen to switch to the statistics display interface.

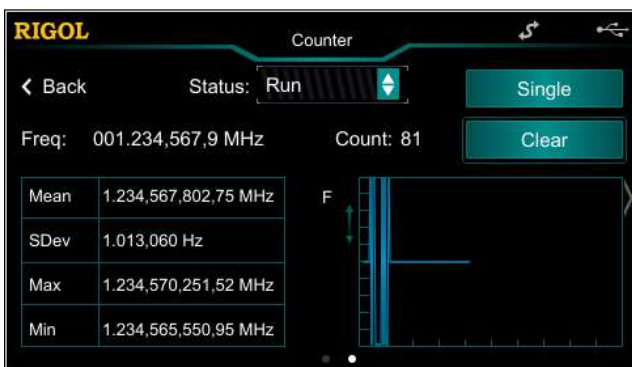

Figure 2-16 Statistics Display Interface

**(1) To Clear the Statistics Results**

Tap the "Clear" menu label, and the signal generator clears the current statistics results.

**(2) Operating Status**

Tap the **Status** parameter selection field to select the running status of the frequency counter. When you press **Counter** on the front panel, the frequency counter enters "Run" state automatically and it will continuously measure the input signal according to the current configuration. Tap the **Status** menu label to select "Single". After finishing the current measurement, it enters the "Stop" status.

When the frequency counter enters the "Stop" status, each time you press the **Single** menu label, the frequency counter executes one measurement.

**Note:** When the statistical function is disabled, sliding left in the frequency counter parameter setting interface will switch to the frequency counter parameter measurement interface.



Figure 2-17 Frequency Counter Parameter Measurement Interface

**4. Sensitivity**

Sets the trigger sensitivity of the measurement system. Tap the **Sensitivity** parameter selection field to select "High" or "Low".

**5. Trigger Level**

Sets the trigger level of the measurement system. The system triggers and gets the measurement readings when the input signal reaches the specified trigger level. The default is 0 V, and the range available is from -2.5 V to 2.5 V. Tap the **Trig Lev** parameter input field to input the desired value by using the numeric keypad and select the unit "V" or "mV" from the pop-up menu.

**6. Coupling**

Sets the coupling mode of the input signal to "AC" or "DC". The default is "DC".

## 7. High Frequency Rejection

High frequency rejection can be used to filter out the high-frequency components and improve the measurement accuracy in low-frequency signal measurement. Tap the **High Freq Rejection** parameter selection field to enable or disable the high frequency rejection function.

**Note:** Enable the high frequency rejection when low-frequency signal with less than 200 kHz frequency is measured to filter out the high-frequency noise interference. Disable the high frequency rejection when high-frequency signal with greater than 200 kHz frequency is measured. At this time, the maximum input frequency can be 240 MHz.

## Store and Recall

DG800 can store the current instrument state and user-defined Sequence waveforms in the internal or external memory. You can recall them when needed. DG800 can also seamlessly interconnect with **RIGOL**'s oscilloscopes that support USB-TMC; rebuild and output the waveform data collected by the oscilloscope losslessly.

Press **Store** on the front panel or tap the  icon in the information setting area at the lower-right corner of the user interface to enable the Store/Recall function and open the Store/Recall interface as shown in the figure below.



Figure 2-18 Store and Recall Interface

## Storage System

DG800 can store the current instrument state and user-defined Sequence waveforms in the internal or external memory. You can recall them when needed. DG800 provides an internal non-volatile memory (Disk C) and an external memory (Disk D).

- 1. Disk C:** You can store instrument states and Sequence waveform files (created by users or downloaded through remote commands) to Disk C. Also, you can copy the files from Disk C to the USB storage device.
- 2. Disk D:** available when the USB storage device is detected by the rear-panel USB HOST interface.  
You can store state files or arbitrary waveform files to Disk D. The number of the files that can be stored is determined by the storage capacity of the USB storage device.  
The Csv files and Bmp files stored in the USB storage device can also be read.

**Note:** DG800 can only identify the file whose filename is named in the filename input interface. If other characters are used to name the file, the name might not be normally displayed in the store and recall interface.

## File Type

The file types supported by DG800 include State File, Arb File, Csv File, and Bmp File.

### 1. State File

Stores the instrument state in the internal or external memory in "\*.RSF" format.

The state file stored includes the dual-channel selected waveform, frequency, amplitude, offset, duty cycle, symmetry, phase, modulation, sweep, burst parameters, frequency counter parameters, as well as utility function parameters and system parameters under the Utility menu.

### 2. Arb File

Stores the user-defined arbitrary waveform in the internal or external memory in "\*.RAF" format.

For the arbitrary waveform file, the voltage values corresponding to each waveform point are stored in binary data format. The voltage value at each point takes up 2 bytes (16 bits). Therefore, its format of the binary data is from 0x0000 to 0xFFFF.

The stored arbitrary waveform files can be read by the DG800 series. Besides, the arbitrary waveform files stored in the USB storage device can be opened and edited by data editing tools (e.g. WinHex or UltraEdit) on the PC.

### 3. Csv File

Reads the data file in Csv format from the external memory. After finishing reading the file, the instrument automatically enters the arb waveform function interface. The arbitrary waveforms that have been read are stored in the RAM.

### 4. Bmp File

Reads the "\*.BMP" format bitmap file from the external memory. It is only available when you self-define splash screen.

## Categories

In the Store and Recall interface, tap the "**Arb File**" or "**State File**" under the **Categories** menu label to view the arb file or state file in the first-level folder of Disk C and D (when inserted with a USB storage device).

You can also use the Left arrow key to locate the cursor to the left side of the user interface, and then rotate the knob to select the "**Arb File**" or the "**State File**" folder. Press down the knob to enter the current directory.



## File Operation

In the Disk C or D (when inserted with a USB storage device), you can perform a series of operations on the files, including Save, Read, Copy, Paste, and Delete.

### Save

#### 1. To Select the Save Path

Selects Disk C or D (when inserted with a USB storage device) as the current save path.

You can tap Disk C or D to enter the current directory. You can also use the Left arrow key to locate the cursor to the left side of the user interface, and then rotate the knob to select Disk C or D. Press down the knob to enter the current directory.

Only the state file and the arb file can be saved locally. If the current file is "Arb File", press **Menu** → **Advanced** → **"Sequence"**. In the Sequence editing interface, tap **"Store"** to save the file.

#### 2. To Open the Filename Input Interface

After selecting the path, tap **Save** to enter the filename input interface, as shown in the following figure.

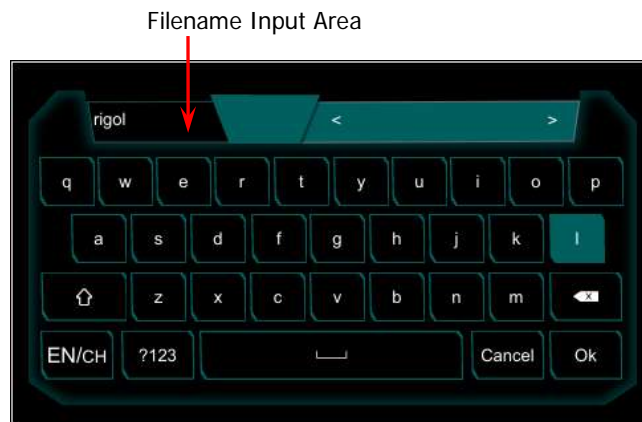



Figure 2-19 Filename Input Interface (English)

#### 3. To Input a Filename

The length of the filename is limited to 7 characters.

- Input English Letters:

Tap **EN/CH** in the filename input interface to select English input method (EN is highlighted). Tap **↕** to switch between the upper-case and lower-case letters.

Tap the desired character, and the selected character will be displayed in the filename input area. Use the same method to input all the characters of the filename. You can also tap  the delete the unwanted characters in the filename input area.

- Input Numbers



Tap  in the filename input interface to switch to the numbers and symbols selection interface, as shown in the following figure. The input method is similar with that of the English input.



Figure 2-20 Filename Input Interface (Numbers)

- Input Chinese



Tap  in the filename input interface to select Chinese input method (CH is highlighted). Note that if the current interface is number input interface, tap  to switch to English input interface. Then, select Chinese input.

Filename Input Area   Pinyin Input Area   Chinese Character Display Area



Figure 2-21 Filename Input Interface (Chinese)

Tap the desired character, and the selected character will be displayed in

the Pinyin input area. After inputting the Pinyin for a Chinese character, tap the desired Chinese character in the Chinese character display area (if no proper Chinese character exists, tap  or  to page down to search for the desired Chinese character). The selected Chinese character will be displayed in the filename input area. Use the same method to input all the Chinese characters of the filename. You can also tap  to delete the unwanted characters in the Pinyin input area, and then delete the Chinese character located ahead of the cursor in the filename input area.

#### 4. To Save a File

After finishing inputting filename in the filename input interface, press "Ok", and the generator will save the file with the specified filename to the currently selected directory. Tap "Cancel" to cancel the save operation.

## Read

#### 1. To Select the Read Path

Selects Disk C or D (when inserted with a USB storage device) as the current read path.

You can tap Disk C or D to enter the current directory. You can also use the Left arrow key to locate the cursor to the left side of the user interface, and then rotate the knob to select Disk C or D. Press down the knob to enter the current directory.

#### 2. To Select the File to be Read

In the selected path, tap or use the knob to select the file to be read.

For Disk C, only state file and arb file can be read. For Disk D, the state files, arb waveform files, Csv files, and bitmap files can be read. Note: the bitmap file can only be read when you self-define splash screen.

#### 3. Read a file

Press **Read**, and the generator will read the currently selected file and display the corresponding prompt message when the file is read successfully.

## Copy and Paste

#### 1. To Select a File to be Copied

In the selected path, tap or use the knob to select the file to be copied.

#### 2. To Copy a File

Tap **Copy**, the generator will copy the currently selected file.

**3. To Select a Paste Location**

- When copying file from Disk C to Disk D, tap or use the knob to select the Disk D directory.
- When copying file from Disk D to Disk C, tap or use the knob to select the Disk C directory.

**4. To Paste a File**

Tap **Paste**, the generator will paste the copied file to the currently selected directory. After that, a corresponding prompt message will be displayed, indicating that the paste operation is completed.

**Delete****1. To Select a File to be Deleted**

In the selected path, tap or use the knob to select the file to be deleted.

**2. To Delete a File or Folder**

Tap **Delete**, the generator will delete the currently selected file.

## Seamless Interconnection with Oscilloscope

DG800 can also seamlessly interconnect with **RIGOL's** oscilloscopes that support USB-TMC; rebuild and output the waveform data collected by the oscilloscope losslessly. The connection method between the instruments is as shown in the figure below.

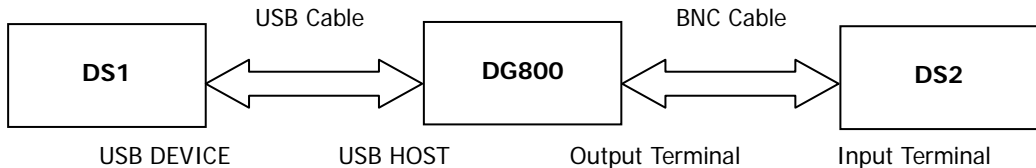

### Operation Procedures:

1. Make sure the signal under test is displayed stably on the screen of DS1.
2. Connect the USB HOST interface of DG800 with the USB DEVICE interface of DS1 by using the USB cable. Now, DS1 will enter the remote mode automatically.
3. Use DG800 to read the signal under test that is displayed currently on the screen of DS1: Press **Store** on the front panel of DG800 to enter the store and recall interface. At this time, the **Oscilloscope** menu label is displayed below the **Categories** menu label, and the model identifier of DS1 will be displayed under **Oscilloscope**. Tap or use the knob of DG800 to select the DS1 model identifier to enter the seamless interconnection operation interface.



Figure 2-22 Seamless Interconnection Operation Interface

All the channels of DS1 and their on/off status are displayed at the left section of the interface. The parameter settings are displayed at the right section of the interface. Tap the first parameter selection field to set the data type of the current channel to be read to "Screen Data" or "Ram Data". Tap the second parameter selection field to set the data position (only available when data type

is set to "Ram Data"), and its available choices include "Head Pos", "Trig Pos", and "Tail Pos".

Tap or use the knob to select the channel to be read, and then set the parameters of the corresponding channel. Tap **Read**. At this time, DS1 will enter the "Stop" status automatically, and DG800 will read the arbitrary waveform data (i.g. the waveform data collected by DS1) automatically. After reading the data, the instrument saves them to the internal RAM of the current channel and switches to Sequence mode (if the current mode is not Sequence mode) automatically.

4. Use the BNC cable to connect the output of the current channel of DG800 to the input of DS2. Turn on the channel output and DG800 will output the arbitrary waveform collected by DS1. You can observe the waveform collected by DS1 from DS2 by setting DS2.

## Channel Setting

The function and setting methods of CH2 are the same as that of CH1. This section takes CH1 as an example to introduce the channel setting method. To set the CH2 channel output parameters, select CH2 (refer to "**To Select Output Channel**") and then set the channel according to the descriptions in this section.



Tap the channel output configuration status bar  or  under the user interface to enter the channel setting interface. Tap the corresponding menu label to set the parameters related with the channel.



Figure 2-23 Channel Setting Interface

## Output Setting

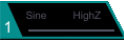
### 1. Output On/Off

Enable or disable the signal on the **[CH1]** connector. In the channel setting interface, tap the **OutputSet** menu label, and then tap the **Output** parameter selection field to select "On" or "Off" to enable or disable the signal output. By default, it is set to "Off".

### 2. Output Polarity

Set the signal on the **[CH1]** connector as Normal or Inverted. Waveform is inverted relative to the offset voltage. In the channel setting interface, tap the **OutputSet** menu label, and then tap the **Inverted** parameter selection field to select "On" or "Off". By default, it is set to "Off". If "Off", the instrument outputs the normal waveform; if "On", the instrument outputs the inverted waveform. For example, if Inverted is "Off" (normal mode), the first half period of the waveform in the cycle is Positive; if Inverted is "On", the first half period of the waveform in the cycle is Negative, as shown in the figure below.

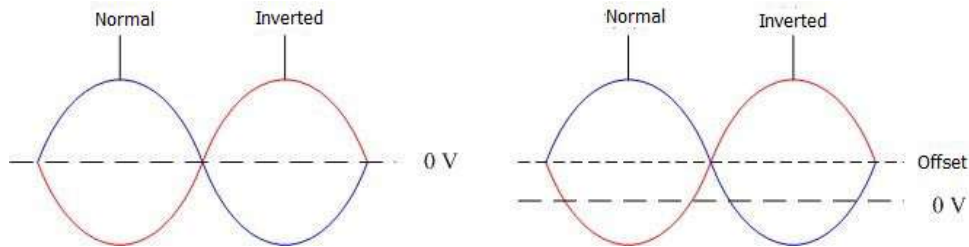

**Note:** When the waveform is inverted, the sync signal related to the waveform is not inverted. To set the invert of the sync signal, tap **SyncSet** → **Polarity** to select "Negative".

### 3. Output Impedance

The output impedance setting affects the output amplitude and DC offset. The instrument has a  $50\ \Omega$  fixed serial output impedance for the front-panel **[CH1]** connector. If the actual load is different from the specified value, then the displayed voltage level will not match the voltage level of the components under test. To ensure a correct voltage level, ensure that the load impedance setting must match the actual load.

In the channel setting interface, tap the **OutputSet** menu label, and then tap the **HighZ** parameter selection field to select "On" or "Off". The default is "On". When "Off", tap the **Impedance** menu label, and input the desired value by using the numeric keypad. You can also use the arrow keys and the knob to set the impedance. The default is  $50\ \Omega$ , and the range is from  $1\ \Omega$  to  $10\ \text{k}\Omega$ . Impedance setting will be displayed on the screen.

The generator will adjust the output amplitude and offset voltage automatically once the impedance setting is modified. For example, the current amplitude is 5 Vpp. At this point, modify the output impedance from " $50\ \Omega$ " to "HighZ". Then, the amplitude value displayed on the screen will be doubled to 10 Vpp. If the output impedance is modified from "HighZ" to " $50\ \Omega$ ", the amplitude value will be reduced to half of the previous value (i.g. 2.5 Vpp). Note that only the displayed values change with the parameter and the actual output from the generator does not change.

### 4. Level Limit

Enables or disables the level limit function.

In the channel setting interface, tap the **OutputSet** menu label, and then tap the **Level Limit** parameter selection field to select "On" or "Off". By default, it is set to "Off". When "On", the set high level and low level values will be limited within the range of the "HighL Limit" and "LowL Limit".

Tap **HighL Limit** and **LowL Limit** respectively, and then use the numeric keypad to set the desired high level limit and low level limit. The settable ranges of the high level limit and low level limit are determined by the currently set amplitude and offset values.



## Sync Setting

DG800 can output the basic waveforms (except Noise and DC), arb waveforms, harmonics, sweep waveforms, burst waveforms, and the sync signal of the modulated waveforms from a single channel or the dual channels at the same time. The signal will be output from the rear-panel **[CH1/Sync/Ext Mod/Trig/FSK]** connector.

### 1. Sync Switch

Enables or disables the sync signal on the **[CH1/Sync/Ext Mod/Trig/FSK]** connector. In the channel setting interface, tap the **SyncSet** menu label, and then tap the **SyncState** parameter selection field to select "On" or "Off" to enable or disable the sync signal output. By default, it is "On". That is, send the sync signal to the **[CH1/Sync/Ext Mod/Trig/FSK]** connector. When disabling the sync signal, the output level on the **[CH1/Sync/Ext Mod/Trig/FSK]** connector is the logic low level.

### 2. Sync Polarity

Sets the signal on the **[CH1/Sync/Ext Mod/Trig/FSK]** connector as "Normal" or "Inverted". In the channel setting interface, tap the **SyncSet** menu label, and then tap the **Polarity** parameter selection field to select "Positive" or "Negative".

- Positive: outputs the normal sync signal.
- Negative: outputs the inverted sync signal.

### Key Points:

#### Sync signals of various waveforms:

##### 1. Basic Waveforms

- 1) When the frequency of the basic waveform is less than or equal to 100 kHz:

The sync signal is a Square with 50% duty cycle, and the same frequency as that of the basic waveform. When the first waveform point is output, the sync signal is TTL high level.

- 2) When the frequency of the basic waveform is greater than 100 kHz:

- Sine and Ramp: the sync signal is a Square with 50% duty cycle.
  - Square and Pulse: the sync signal is a Square with a variable duty cycle. The duty cycle varies with the duty cycle of the output signal.
- Take 0 V voltage or the DC offset of the basic waveform as the reference, the sync signal is TTL high level when the corresponding value of the output signal is greater than the reference value. When the frequency of the basic waveform is less than or equal to 30 MHz, the sync signal has the same frequency as the basic waveform. When the frequency of the basic waveform is greater than 30 MHz, the frequency of the sync signal

is (the basic waveform frequency  $\div 2^n$ ). Wherein, n represents the frequency dividing coefficient and it is 1 when the frequency of the basic waveform is greater than 30 MHz and less than or equal to 60 MHz.

3) Noise: there is no sync signal output.

## 2. Harmonic

For harmonics, the sync signal is a Square with 50% duty cycle, and its frequency is the same as that of the fundamental waveform. When the first waveform point is output, the sync signal is TTL high level.

## 3. Arbitrary Waveform

For arbitrary waveforms, the sync signal is a Square with 50% duty cycle, and its frequency is the same as that of the arbitrary waveform. When the first waveform point is output, the sync signal is TTL high level.

## 4. Modulated Waveform

1) When internal modulation source is selected, the sync signal is a Square with 50% duty cycle.

- For AM, FM, PM, and PWM, the frequency of the sync signal is the modulating frequency.
- For ASK, FSK, and PSK, the frequency of the sync signal is the modulating rate.

2) When external modulation source is selected:

The terminal is used to receive the external modulation signal, and there is no sync signal output.

## 5. Sweep Output Waveform

1) When the internal or manual trigger source is selected:

- For the sweep with "Marker Freq" off:  
The sync signal is a Square with 50% duty cycle. The sync signal is TTL high level at the start of the sweep and changes to low level at the mid-point of the sweep. The frequency of the sync signal is the reciprocal of the sum of the specified sweep time, return time, start hold, and stop hold time.
- For the sweep with "Marker Freq" on:  
For linear and log sweep, the sync signal is TTL high level at the start of the sweep and changes to low level at the marker frequency.

For step sweep (the sweep points determined by the start frequency, stop frequency, and step respectively are  $f_1, f_2, \dots, f_n, f_{n+1}, \dots$ ), if the marker frequency setting is one of the sweep points values, the sync signal is TTL high level at the start of the sweep and will change to low level at the marker frequency point. If the set marker frequency is not equal to the value at the sweep point, the sync signal will change to low level at the sweep point which is closest to

this marker frequency.

- 2) When external trigger source is selected:  
The terminal is used to receive the external trigger signal, and there is no sync signal output.

#### 6. Burst Waveform

- 1) When the internal or manual trigger source is selected:
  - Infinite burst: the sync signal is the same as that of the basic waveform.
  - N cycle burst: the sync signal is TTL high level at the start of the burst and will change to TTL low level after the specified number of cycles is finished. For the sync signal, the frequency is the **reciprocal of the Burst Period** and the duty cycle is **Carrier Period\*Cycles/Burst Period**.
  - Gated burst: the terminal is used to receive the external gate signal, and there is no sync signal output.
- 2) When external trigger source is selected:  
The terminal is used to receive the external trigger signal, and there is no sync signal output.

## Coupling Setting

DG800 supports frequency, amplitude, and phase couplings. You can set the frequency deviation (frequency ratio), amplitude deviation (amplitude ratio), or phase deviation (phase ratio) of the two channels. When the corresponding coupling functions are enabled, CH1 and CH2 are mutual base sources. When the frequency, amplitude, or phase of one channel (as the base source) is changed, the corresponding parameter of the other channel will be changed automatically and always keeps the specified frequency deviation (ratio), amplitude deviation (ratio), or phase deviation (ratio) relative to the base channel.

In the channel setting interface, tap the **CoupleSet** menu label to enter the channel coupling setting interface.

## Frequency Coupling

### 1. To Enable the Coupling Function

Tap the **Freq Cpl** parameter selection field to select "On" or "Off" to enable or disable the frequency coupling function. By default, it is set to "Off".

### 2. Freq Coupling Mode

Tap the **FreqCplMode** parameter selection field to select "Deviation" or "Ratio". Then, tap the **Freq Dev** or **Freq Ratio** parameter selection field to input the

desired value by using the numeric keypad, the arrow keys, or the knob.

- **Freq Deviation:** indicates the frequency deviation between CH1 and CH2. The relations among the parameters are as follows:  $F_{CH2}=F_{CH1}+F_{Dev}$  (take CH1 as the reference source);  $F_{CH1}=F_{CH2}+F_{Dev}$  (take CH2 as the reference source).
- **Freq Ratio:** indicates the ratio of the frequencies of CH1 to that of CH2. The relations among the parameters are as follows:  $F_{CH2}=F_{CH1}*F_{Ratio}$  (take CH1 as the reference source);  $F_{CH1}=F_{CH2}*F_{Ratio}$  (take CH2 as the reference source).

**Note:** Please set this parameter before enabling the frequency coupling function. When the frequency coupling is enabled, this menu is grayed out and disabled. You cannot set the frequency deviation or frequency ratio.

## Amplitude Coupling

### 1. To Enable the Coupling Function

Tap the **Ampl Cpl** parameter selection field to select "On" or "Off" to enable or disable the amplitude coupling function. By default, it is set to "Off".

### 2. Amp Coupling Mode

Tap the **AmplCplMode** parameter selection field to select "Deviation" or "Ratio". Then, tap the **Ampl Dev** or **Ampl Ratio** parameter input field to input the desired value by using the numeric keypad.

- **Ampl Deviation:** indicates the amplitude deviation between CH1 and CH2. The relations among the parameters are as follows:  $A_{CH2}=A_{CH1}+A_{Dev}$  (take CH1 as the reference source);  $A_{CH1}=A_{CH2}+A_{Dev}$  (take CH2 as the reference source).
- **Ampl Ratio:** indicates the ratio of the amplitudes of CH1 to that of CH2. The relations among the parameters are as follows:  $A_{CH2}=A_{CH1}*A_{Ratio}$  (take CH1 as the reference source);  $A_{CH1}=A_{CH2}*A_{Ratio}$  (take CH2 as the reference source).

**Note:** Please set this parameter before enabling the amplitude coupling function. When the amplitude coupling is enabled, this menu is grayed out and disabled. You cannot set the amplitude deviation or amplitude ratio.

## Phase Coupling

### 1. To Enable the Coupling Function

Tap the **Phase Cpl** parameter selection field to select "On" or "Off" to enable or disable the phase coupling function. By default, it is set to "Off".

### 2. PhasCplMod

Tap the **PhasCplMode** parameter selection field to select "Deviation" or "Ratio".

Then, tap the **Phase Dev** or **Phase Ratio** parameter input field to input the desired value by using the numeric keypad.

- **Phase Deviation:** indicates the phase deviation between CH1 and CH2. The relations among the parameters are as follows:  $P_{CH2} = P_{CH1} + P_{Dev}$  (take CH1 as the reference source);  $P_{CH1} = P_{CH2} + P_{Dev}$  (take CH2 as the reference source).
- **Phase Ratio:** indicates the ratio of the phases of CH1 to that of CH2. The relations among the parameters are as follows:  $P_{CH2} = P_{CH1} * P_{Ratio}$  (take CH1 as the reference source);  $P_{CH1} = P_{CH2} * P_{Ratio}$  (take CH2 as the reference source).

**Note:** Please set this parameter before enabling the phase coupling function. When the phase coupling is enabled, this menu is grayed out and disabled. You cannot set the phase deviation or phase ratio.

## Trigger Coupling

Tap the **Trig Coupling** parameter selection field to select "On" or "Off" to enable or disable the trigger coupling function. By default, it is set to "Off".

When enabling the output of the two channels at the same time and enabling the trigger coupling, if one channel executes the trigger, then another channel will be triggered automatically.

When the corresponding coupling function is enabled, there will be a blue mark  at the left side of the frequency, amplitude, and phase of the two channels. As shown in the following figure, the frequency, amplitude, and phase are in the coupling state. For example, when the frequency, amplitude, and phase deviations are set to "100Hz", "1Vpp", and "10°" respectively, and the frequency, amplitude, phase of CH1 are modified to "200Hz", "2Vpp", and "20°", then the corresponding parameters of CH2 will be automatically modified to "300Hz", "3Vpp", and "30°". Switch to CH2 and modify the frequency, amplitude, phase of CH2 to "200Hz", "2Vpp", and "20°", then, the corresponding parameters of CH1 will be automatically modified to "100Hz", "1Vpp", and "10°".

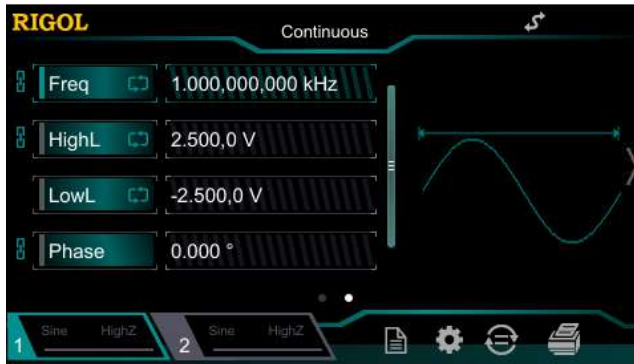

Figure 2-24 Channel Coupling

**Key Points:**

- Channel coupling is only available when both the waveforms of the two channels are basic waveforms (Sine, Square, Ramp, or Arbitrary waveform).
- The generator will adjust the frequency, phase, or amplitude of the channel to avoid parameter over-limit if the following conditions occur: 1. the result of the frequency, amplitude or phase value of CH1 plus (or multiply) the set deviation (or ratio) exceeds the upper limit of frequency, amplitude or phase of CH2; 2. the result of the frequency, amplitude or phase value of CH2 minus (or is divided by) the set deviation (or ratio) is below the lower limit of frequency, amplitude or phase of CH1.
- When the phase of the one channel is modified, the phase (phase displayed on the interface) of the other channel will be modified accordingly. At this point, aligning phase between the two channels can be realized without executing the Align Phase operation.

**Track Mode**

Tap the **Track Mode** parameter selection field and select the track type to "On", "Inverted", or "Off".

- On: enables the track function. The instrument copies the various parameters and states (except the channel output state) of CH1 to CH2 automatically. When the parameters or states of CH1 are modified, the corresponding parameters or states of CH2 (except the channel output state) will be adjusted to the same values or states automatically. At this time, the dual channels (if currently enabled) can output the same signal.
- Inverted: the track function has been enabled. The instrument copies the various parameters and states (except the channel output state) of CH1 to CH2 automatically. When the parameters or states of CH1 are modified, the corresponding parameters or states of CH2 (except the channel output state) will be adjusted to the same values or states automatically. At this time, CH2 outputs the inverted signal of the output signal of CH1 (if channels are currently

- enabled).
- Off: disables the track function. This is the default state.

**Note:** When the track function is enabled, the coupling function is disabled.

## Waveform Combination

### 1. To Enable the Waveform Combination Function

In the channel setting interface, tap the **CombineSet** menu label and then tap the **Combine** parameter selection field to select "On" to enable the waveform combine function. Then, you can combine the specified waveforms based on the current fundamental waveform. If you select "Off", the waveform combine function is disabled.

**Note:** This function is only valid for the basic waveforms.

### 2. To Select the Waveform to be Combined

In the channel setting interface, tap the **CombineSet** menu label and then tap the **Waveform** parameter selection field to select a waveform to be combined to the current basic waveform.

### 3. Freq Combination

Sets the frequency of the waveform to be combined to the current basic waveform. In the channel setting interface, tap the **CombineSet** menu label and then tap the **Freq** parameter input field to input the desired value by using the numeric keypad. The range is related to the currently selected basic waveform.

### 4. Ratio

Sets the ratio of the amplitude of the waveform to be combined to that of the current basic waveform. In the channel setting interface, tap the **CombineSet** menu label and then tap the **Ratio** parameter input field to input the desired value by using the numeric keypad.

## Common Settings

Press **Utility** on the front panel or tap the  icon in the information setting area at the lower-right corner of the user interface to open the following operation interface. The interface displays the system parameters of the currently selected channel.



Figure 2-25 Utility Interface

## System Setting

### To Set the System Language

At present, DG800 supports menus in multiple languages. Both Chinese and English are available for the display of the help information, prompt messages, and interface display. Chinese and English input methods are also supported.

Press **Utility** → **System Setting** → **Language** to select the desired language. This setting is stored in non-volatile memory and will not be affected by the "restore to defaults" operation.

### Power-on

Selects "Default" or "Last" as the power-on system state. The default setting is "Default".

- Last: includes all system parameters and states, except channel output state and clock source.
- Default: denotes the factory defaults except certain parameters (e.g. Language).

Press **Utility** → **System Setting** → **Power-on** to select the desired configuration type. This setting is stored in non-volatile memory and will not be affected by the "restore to defaults" operation.



## Clock Source

DG800 provides an internal 10MHz clock source and receives the external clock source from the rear-panel **[10MHz In/Out]** connector. It can also output clock source from the **[10MHz In/Out]** connector for other devices.

Press **Utility** → **System Setting** → **Clk Source** to select "Internal" or "External". The default is "Internal". If "External" is selected, the instrument will detect whether a valid external clock signal is input from the rear-panel **[10MHz Out/In]** connector. If no valid clock source is detected, a prompt message "No valid external clock is detected!" is displayed, and the clock source will be switched to "Internal".

You can synchronize two or multiple instruments by setting the clock source. When two instruments are synchronized, the "Align Phase" function cannot be used. It is only applicable in adjusting the phase relations between two output channels of the same instrument and cannot be used to change the phase relations between the output channels of two instruments. Of course, you can change the phase relations between two instruments by modifying the "Start Phase" of each output channel.

### Sync methods for two or multiple instruments:

- Synchronization between two instruments:  
Connect the **[10MHz In/Out]** connector of Generator A ("Internal" clock) to the **[10MHz In/Out]** connector of Generator B ("External" clock) and set the output frequencies of A and B as the same value to realize synchronization between two instruments.
- Synchronization among multiple instruments:  
Divide the 10MHz clock source of a Generator ("Internal" clock) into multiple channels, and then connect them to the **[10MHz In/Out]** connectors of other generators ("External" clock) respectively, and finally set the output frequencies of all the generators as the same value to realize synchronization among multiple instruments.

## Beeper

When the beeper in DG800 is enabled, a beep sound is generated when an error occurs during front-panel operation, touch screen operation, or remote operation.

Press **Utility** → **System Setting** → **Beeper** to select "On" or "Off". The default is "On".

## Decimal Point

Press **Utility** → **System Setting** → **Decimal** to set the display format of the

decimal point in the number parameter. It can be set to a decimal "." or a comma ",". By default, it is a decimal ".". This setting is stored in non-volatile memory and will not be affected by the "restore to defaults" operation.

## Delimiter

Press **Utility** → **System Setting** → **Delimiter** to set the display format of the delimiter in the number parameter. This setting is stored in non-volatile memory and will not be affected by the "restore to defaults" operation.

When the decimal is set to ".", the delimiter can be set to ",", "Space", or "None"; when the decimal point is set to ",", the delimiter can be set to ".", "Space", or "None". The decimal point and the delimiter cannot be set to a decimal "." or a comma "," at the same time.

## System Log

Enables or disables the system log function. When enabled, the keys and prompt messages can be recorded, and they will be saved to the internal memory in Syslog.log file format.

Press **Utility** → **System Setting** → **System Log** to select "On" or "Off". The default is "Off".

## Interface

Press **Utility** → **Interface** to select a different interface type. You can set the GPIB address, LAN interface parameters, or select the type of the device connected to the USB interface. The interface selection is stored in the non-volatile memory.

### To Set the GPIB Address

Each device connected to GPIB interface must have a unique address.

Press **Utility** → **Interface** → **GPIB**, and then use the numeric keypad to set the GPIB address to any value ranging from 0 to 30. The default is "2". The selected address is stored in the non-volatile memory.

## To Set the LAN Parameters

Press **Utility** → **Interface** → **LAN** to open the LAN parameters configuration interface as shown in the figure below. You can view the network status and configure the network parameters.

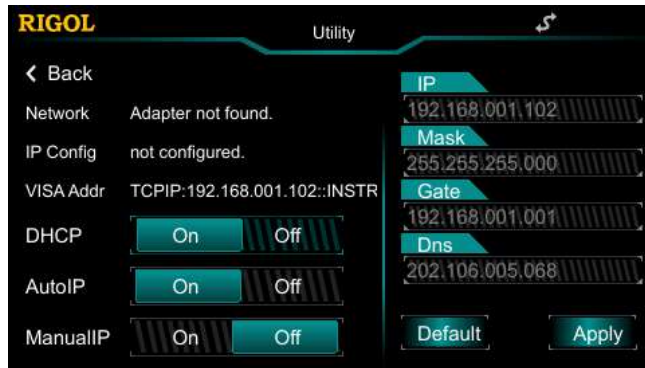

Figure 2-26 LAN Setting Interface

## Network Status

Different prompt messages will be displayed based on the current network status.

- Connected: indicates that the network connection is successful.
- Disconnect: indicates that the network connection is failed.
- Adapter not found: indicates that the network is not connected.

## IP Configuration

IP configuration mode can be DHCP, AutoIP, or ManualIP. In different IP configuration modes, the configurations for the IP address and other network parameters are different.

### 1. DHCP

- In DHCP mode, the DHCP server in the current network assigns the network parameters (e.g. IP address) for the signal generator.
- Tap the **DHCP** parameter selection field to select "On" or "Off" to turn DHCP mode on or off.

### 2. AutoIP

- In Auto IP mode, the generator acquires IP address within the range from 169.254.0.1 to 169.254.255.254, and gets the subnet mask 255.255.0.0 automatically according to the current network configuration.
- Tap the **AutoIP** parameter selection field to select "On" or "Off" to turn the AutoIP mode on or off. When DHCP and AutoIP modes are turned on at the

same time, the DHCP mode takes precedence. Therefore, to enable this mode, set DHCP to "Off".

### 3. ManualIP

- In ManualIP mode, the network parameters of the generator, e.g. IP address, are defined by users.
- Tap the **ManualIP** parameter selection field to select "On" or "Off" to turn the ManualIP mode on or off. If all the three IP configuration modes are set to "On", the priority of parameters configuration from high to low is "DHCP", "AutoIP", and "ManualIP". Therefore, to enable this mode, set DHCP and AutoIP to "Off".
- The format of the IP address is "nnn.nnn.nnn.nnn". The range for the first segment (nnn) of the address is from 1 to 223 (except 127); and the range for the other three segments is from 0 to 255. You are recommended to ask your network administrator for an IP address available.
- Tap the **IP** parameter input field in the LAN setting interface, and then input a desired IP address by using the numeric keypad. The setting is stored in the non-volatile memory and will be loaded automatically at next power-on if DHCP and AutoIP are set to "Off".

#### Tip:

- If all the three IP configuration modes are set to "On", the priority of parameters configuration from high to low is "DHCP", "AutoIP", and "ManualIP".
- The three IP configuration modes cannot be set to "Off" at the same time.

## VISA Address

VISA (Virtual Instrument Software Architecture), developed by NI (National Instrument), provides an advanced programming interface to communicate with various instruments through their bus lines. VISA enables you to communicate with the instrument in the same way, regardless of the interface type of the instrument (e.g. GPIB, USB, LAN/Ethernet, or RS232). The GPIB, USB, LAN/Ethernet or RS232 instrument which wants to communicate with VISA is called "resource".

VISA descriptor is the resource name and it describes the accurate name and location of the VISA resource. If LAN interface is currently used for communication with the instrument, the VISA descriptor is TCPIP0::192.168.001.102::INSTR.

## To Set the Subnet Mask

In ManualIP mode, the subnet mask can be manually set.

- The format of the subnet mask is nnn.nnn.nnn.nnn. Wherein, the range of "nnn"

is from 0 to 255. You are recommended to ask your network administrator for a subnet mask available.

- Tap the **Sub** parameter input field in the LAN setting interface, and then input a desired subnet mask by using the numeric keypad. The setting is stored in non-volatile memory and will be automatically loaded when the generator is powered on the next time if DHCP and AutoIP are set as "Off".

## To Set Default Gateway

In ManualIP mode, the default gateway can be manually set.

- The format of the default gateway is "nnn.nnn.nnn.nnn". The range for the first segment (nnn) is from 1 to 223 (except 127); and the range for the other three segments is from 0 to 255. You are recommended to ask your network administrator for a gate address available.
- Tap the **Gate** parameter input field in the LAN setting interface, and then input a desired gateway address by using the numeric keypad. The setting is stored in non-volatile memory and will be automatically loaded when the generator is powered on the next time if DHCP and AutoIP are set to "Off".

## To Set DNS

In ManualIP mode, the DNS can be manually set.

- The format of the DNS address is "nnn.nnn.nnn.nnn". The range for the first segment (nnn) of the address is from 1 to 223 (except 127); and the range for the other three segments is from 0 to 255. You are recommended to ask your network administrator for an address available.
- Tap the DNS parameter input field in the LAN setting interface, and then input a desired address by using the numeric keypad, the arrow keys, and the knob. The setting is stored in the non-volatile memory and will be automatically loaded when the generator is powered on the next time if DHCP and AutoIP are set to "Off".

## Default Settings

Tap **Default** to restore the network parameters to the default settings. By default, DHCP and AutoIP are enabled and ManualIP is disabled.

## Apply

Tap **Apply** to apply the currently set network parameters.

## System Info

Press **Utility** → **System Info**, and the model, serial number, and software version number of the current instrument are displayed in the system information interface.

## Option

Press **Utility** → **Option**, and the installation status of the options for the current instrument is displayed in the system information interface (for the installation of the option, refer to "**To Install the Option**").

## Display Setting

Press **Utility** → **DispSet** to enter the display setting interface.

### 1. Brightness Setting

Tap the **Brightness** parameter input field and use the numeric keypad to modify the brightness. The range is from 1% to 100%. The default is 50%. This setting is stored in non-volatile memory and will not be affected by the "restore to defaults" operation.

### 2. Screen Saver

Enables or disables the screen saver mode. Tap the **Screen Saver** parameter selection field to select "On" or "Off" to enable or disable the screen saver function. By default, it is set to "Off".

### 3. Splash Screen

DG800 allows you to self-define the splash screen. You can save the contents displayed on the screen to the USB storage device in BMP format. Insert a USB storage device into the USB HOST interface on the rear panel. Tap "**Recall**" at the right side of the **Splash Screen** menu label to enter the store and recall interface. Select the desired file in BMP format and tap **Read**.

**Note:** The internal memory cannot store the file in BMP format. You need to store the contents in the USB storage device in BMP format first. The size of the image cannot exceed 480\*272.

## Print Setting

You can store the contents displayed on the screen in the external USB storage device in picture format.

1. Insert a USB storage device into the USB HOST interface on the rear panel.
2. Press **Utility** → **Print** → **Format** to select "BMP" or "PNG".
3. Switch the content displayed on the screen to the interface to be printed. Tap  at the lower-right corner of the user interface. The system will store the screen in the USB storage device in the image format according to the preset settings.

# System Utility Function

## To Restore Preset

Press **Preset** to restore the preset status interface, as shown in the figure below.

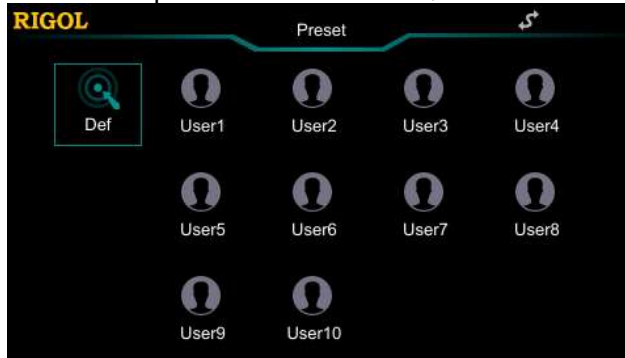

Figure 2-27 Preset Status Restore Interface

- Factory: Tap the **Def** icon, then a dialog box is displayed, tap **"Apply"** to restore the system to its factory defaults.
- User save: Tap any one of the items from **"User1"** to **"User10"**. Then a dialog box is displayed. Tap **"Save"** to save the current system status to the internal non-volatile memory as user-defined settings. To use the state again, tap the icon (any one of the items from **"User1"** to **"User10"**) to quickly recall the setting. You can store up to 10 system states.

The defaults are shown in the following table. Note that the item with "\*" is the factory default value, and its value is related to the user setting during its usage but not affected by the factory default restore operation.

Table 2-4 Factory Defaults

| Parameter                | Factory Settings |
|--------------------------|------------------|
| <b>Channel Parameter</b> |                  |
| Current Carrier Waveform | Sine             |
| Output Impedance         | HighZ            |
| Output Load              | 50 Ω             |
| Channel Output           | Off              |
| Output Inverted          | Off              |
| Level Limit              | Off              |
| HighL Limit              | 0 V              |
| LowL Limit               | 0 V              |
| SyncState                | Off              |
| Sync Polarity            | Negative         |
| Freq Cpl                 | Off              |



|                              |                   |
|------------------------------|-------------------|
| FreqCplMode                  | Deviation         |
| Freq Dev                     | 0 $\mu$ Hz        |
| Freq Ratio                   | 1                 |
| Ampl Cpl                     | Off               |
| AmplCplMode                  | Deviation         |
| Ampl Dev                     | 0 Vpp             |
| Ampl Ratio                   | 1                 |
| Phase Cpl                    | Off               |
| PhaseCplMode                 | Deviation         |
| Phase Dev                    | 0°                |
| Phase Ratio                  | 1                 |
| Trig Coupling                | Off               |
| Track Mode                   | Off               |
| Combine                      | Off               |
| Waveform                     | Sine              |
| Freq                         | 1 kHz             |
| Ratio                        | 10%               |
| <b>Basic Waveforms</b>       |                   |
| Frequency                    | 1 kHz             |
| Amplitude                    | 5 Vpp             |
| Amplitude Unit               | Vpp               |
| Offset                       | 0 V <sub>dc</sub> |
| Phase                        | 0°                |
| Square Duty Cycle            | 50%               |
| Ramp Waveform Symmetry       | 50%               |
| Pulse Duty Cycle             | 50%               |
| Pulse Width                  | 500 $\mu$ s       |
| Pulse Rising Edge            | 10 ns             |
| Pulse Falling Edge           | 10 ns             |
| Harmonic Type                | Even              |
| Harmonic Order               | 2                 |
| Harmonic Phase (7)           | 0°                |
| Harmonic No.                 | 2                 |
| Harmonic Amplitude (7)       | 1.2647 Vpp        |
| User                         | X0000000          |
| DC Offset                    | 0 V <sub>dc</sub> |
| Built-in Arbitrary Waveforms | Sinc              |
| <b>Advanced Waveform</b>     |                   |
| Amplitude                    | 5 Vpp             |
| Offset                       | 0 V <sub>dc</sub> |
| PRBS Bit Rate                | 2 kbps            |
| PRBS Data                    | PRBS7             |

|                       |               |
|-----------------------|---------------|
| RS232 Baud Rate       | 9600          |
| RS232 Data Bits       | 8             |
| RS232 Stop Bits       | 1             |
| RS232 Parity Bit      | None          |
| RS232 Data            | 85            |
| Sequence Filter       | Interpolation |
| Sequence Sample Rate  | 1 MSa/s       |
| Sequence Phase        | 0°            |
| <b>Modulation</b>     |               |
| <b>AM Modulation</b>  |               |
| Source                | Internal      |
| Mod.Wave              | Sine          |
| Mod.Freq              | 100 Hz        |
| Mod.Depth             | 100%          |
| DSSC                  | Off           |
| <b>FM Modulation</b>  |               |
| Source                | Internal      |
| Mod.Wave              | Sine          |
| Mod.Freq              | 100 Hz        |
| Freq.Dev              | 1 kHz         |
| <b>PM Modulation</b>  |               |
| Source                | Internal      |
| Mod.Wave              | Sine          |
| Mod.Freq              | 100 Hz        |
| Phas.Dev              | 90°           |
| <b>ASK Modulation</b> |               |
| Source                | Internal      |
| Mod.Rate              | 100 Hz        |
| Mod.Ampl              | 2 Vpp         |
| Polarity              | Positive      |
| <b>FSK Modulation</b> |               |
| Source                | Internal      |
| Mod.Rate              | 100 Hz        |
| Hop Freq              | 10 kHz        |
| Polarity              | Positive      |
| <b>PSK Modulation</b> |               |
| Source                | Internal      |
| Mod.Rate              | 100 Hz        |
| Phase                 | 180°          |
| Polarity              | Positive      |
| <b>PWM Modulation</b> |               |
| Source                | Internal      |
| Mod.Wave              | Sine          |

|                              |                       |
|------------------------------|-----------------------|
| Mod.Freq                     | 100 Hz                |
| Width Deviation              | 200 $\mu$ s           |
| Duty Deviation               | 20%                   |
| <b>Sweep</b>                 |                       |
| Sweep Time                   | 1 s                   |
| Return Time                  | 0 ms                  |
| Start Freq                   | 100 Hz                |
| Stop Freq                    | 1 kHz                 |
| Center Frequency             | 550 Hz                |
| Frequency Span               | 900 Hz                |
| Start Hold Time              | 0 ms                  |
| Stop Hold Time               | 0 ms                  |
| Marker                       | Off                   |
| Marker Freq                  | 550 Hz                |
| Trigger Source               | Internal              |
| Trig In                      | RisEdge               |
| Step                         | 2                     |
| <b>Burst</b>                 |                       |
| Cycles                       | 1                     |
| Period                       | 10 ms                 |
| Gated Polarity               | Positive              |
| Idle Level                   | 1 <sup>st</sup> Point |
| Trigger Source               | Internal              |
| Trig Out                     | Off                   |
| Trig In                      | RisEdge               |
| Delay                        | 0 ns                  |
| <b>Interface Focus Items</b> |                       |
| Freq/Period                  | Freq                  |
| Ampl/HighL                   | Ampl                  |
| Offset/LowL                  | Offset                |
| Duty/Width                   | Duty                  |
| Start/Center                 | Start                 |
| Stop/Span                    | Stop                  |
| Default Channel              | CH1                   |
| <b>Frequency Counter</b>     |                       |
| Meas.Para                    | Freq                  |
| GateTime                     | 100 ms                |
| Statistics                   | Off                   |
| Sensitivity                  | Low                   |
| Trig Level                   | 0 V                   |

|                         |  |
|-------------------------|--|
| Coupling                | DC                                     |
| High Freq Rejection     | Off                                    |
| <b>System Parameter</b> |  |
| <b>System Setting</b>   |  |
| Language*               | Determined by Factory Delivery Setting |
| Power-on                | Default                                |
| Clk Source              | Internal                               |
| Beeper                  | On                                     |
| Decimal                 | Dot                                    |
| Delimiter               | Comma                                  |
| System Log              | Off                                    |
| <b>DispSet</b>          |  |
| Screen Saver            | Off                                    |
| Brightness*             | 100                                    |
| <b>Print Setting</b>    |  |
| Location                | USB Storage Device                     |
| Format*                 | PNG                                    |
| <b>Interface</b>        |  |
| GPIB*                   | 2                                      |
| DHCP*                   | On (default setting in LAN)            |
| Auto IP*                | On (default setting in LAN)            |
| Manual IP*              | Off (default setting in LAN)           |

## Channel Copy

DG800 supports states and waveform copy function between its two channels, i.g. copying all parameters and states (except the channel output state), as well as the arbitrary waveform data of one channel to the other one.

Modify the channel setting of CH1, and then tap  at the lower-right corner of the user interface to copy all parameters and states (except the channel output state), as well as the arbitrary waveform data of CH1 to CH2.

Modify the channel setting of CH2, and then tap  at the lower-right corner of the user interface to copy all parameters and states (except the channel output state), as well as the arbitrary waveform data of CH2 to CH1.

## To Install the Option

DG800 provides various options (for option information, refer to "**Accessories and Options**") to expand the function of the signal generator. If you need to purchase the option, please contact **RIGOL** sales representative. If you have ordered this option, you can obtain the corresponding key. Perform the following operations to install the option.

### 1. Acquire the license of the option

- Log in to the **RIGOL** official website (www.rigol.com), click **License Activation** at the bottom of the webpage to enter the "Registered product license code" interface.
- Input the correct key, serial number (press **Utility** → **System Info** to acquire the serial number of the instrument) and verification code. Click **Generate** to acquire the option license. In the license generation interface, click **Download** to download and save the license file to the PC.

### 2. Install the Option

You can install the option via the following 2 methods.

- 1) Install the option by reading the license file from the USB storage device  
The content and format requirements of the option installation file are as follows.

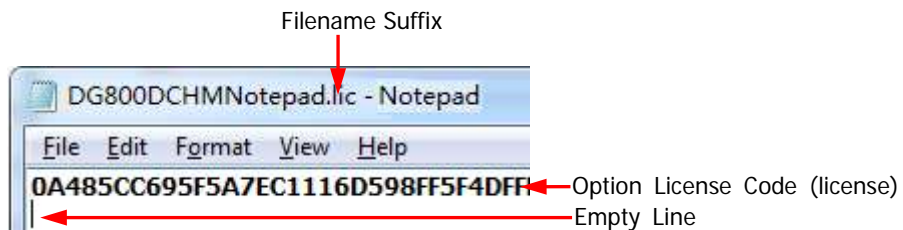

➤ The filename suffix must be ".lic".

➤ Contents requirement:

Line 1: option license code;

Line 2: empty line (cannot be omitted).

**Note:** When inputting the option license obtained in Step 1, omit the hyphens.

#### Procedures for installing the option:

- Edit the option installation file that meets the above requirements and save it to the USB storage device.
- Power on the instrument and insert the USB storage device. Press **Store** to enter the store and recall interface.
- In the store and recall interface, refer to "Store and Recall" to complete reading the option installation file according to the following step. Select "Disk D" to select the above file, and tap the **Read** menu label.

- 2) Install the option by sending SCPI Commands  
Open the remote control window and send the following option installation commands by referring to "**Remote Control**".  
[:LICense:SET <license>](#) or [:LICense:INSTall <license>](#)  
Wherein, [<license>](#) is the option license (note that the hyphens should be omitted).

For example, :LICense:INSTall  
0A485CC695F5A7EC1116D598FF5F4DFFF7D3359266C6A400DA3DE9A5EE  
6F58758BC25E0FA8CAC3D115D3267C419A3496E80629FAA2E8FA632D19  
2E344B1285BB

If the option has been successfully installed, a prompt message will be displayed; otherwise, a message indicating a failed installation will be displayed.

## To Lock the Keyboard

You can lock any key or all the keys on the front panel by using the keyboard lock command.

### 1. Keyboard Lock Command Introduction

```
:SYSTem:KLOCK <key>,{ON|OFF|0|1} /*Locks or unlocks the specified key.*/  
:SYSTem:KLOCK? <key> /*Queries whether the specified key is locked.*/*
```

Wherein, <key> is used to specify the key, and its range is as follows:

|                                     |   |
|-------------------------------------|---|
| HOME MENU PRESET STORE UTILITY HELP | /*Function keys*/                                   |
| LOCK TRIG                           |   |
| LEFT RIGHT KNOB                     | /*Arrow keys and knob*/                             |
| OUTPUT1 OUTPUT2                     | /*Output control keys*/                             |
| COUNTER                             | /*Frequency counter key*/                           |
| ALL                                 | /*All the keys and the knob<br>on the front panel*/ |

{ON|OFF|0|1} is used to lock or unlock the keys. ON|1 denotes locking the specified key and OFF|0 denotes unlocking the specified key.

### 2. Lock the Specified Key by Sending the Command through Ultra Sigma

- Build the communication between the generator and the computer.
- Run Ultra Sigma and search for the instrument resource.
- Open SCPI Panel Control and send the command.  
For the details, refer to "**Remote Control**".





# Chapter 3 Remote Control

DG800 can communicate with PC through USB, LAN, and GPIB (with the USB to GPIB interface converter provided by **RIGOL**) interface. The remote control can be realized by using SCPI (Standard Commands for Programmable Instruments) commands. It can be realized through the following two methods:

## 1. User-defined programming

You can program and control the instrument by using the SCPI commands on the basis of NI-VISA (National Instrument – Virtual Instrument Software Architecture) library. For details about the SCPI commands and programming, refer to *DG800 Programming Guide*.

## 2. PC software

You can use the **RIGOL** PC software (Ultra Sigma) to send the SCPI commands to remotely control the instrument.

This chapter will illustrate how to use the Ultra Sigma software to remotely control the signal generator (take DG832 as an example) via the various interfaces. Please refer to Ultra Sigma help documentation to install the software and the required components correctly. You can download the latest version of the software from [www.rigol.com](http://www.rigol.com).

When the instrument is in remote control, the front panel keys (except the Power key  and **Help/Local** key) and the touch screen are locked. At this time, you can press **Help/Local** to exit the remote mode.

Contents in this chapter:

- Remote Control via USB
- Remote Control via LAN
- Remote Control via GPIB

## Remote Control via USB

### 1. Connect the device

Use the USB cable to connect the rear-panel USB DEVICE interface of the signal generator to the USB HOST interface of the PC.

### 2. Search for the device resource

Start up the Ultra Sigma and the software will automatically search for the generator resources currently connected to the PC. You can also click

**USB-TMC**

to search the resources.

### 3. View the device resource

The resources found will appear under the "RIGOL Online Resource" directory, and the model number and USB interface information of the instrument will also be displayed.

For example, DG832 (USB0::0x1AB1::0x0642::DG8000000001::INSTR).

### 4. Communication test

Right-click the resource name "DG832

(USB0::0x1AB1::0x0642::DG8000000001::INSTR)" and select "SCPI Panel

Control" to turn on the remote command control panel, through which you can send commands and read data. For details about the SCPI commands and

programming, refer to *DG800 Programming Guide*.

## Remote Control via LAN

### 1. Connect the device

Use the USB-LAN interface converter to extend the LAN interface for the signal generator. Use the network cable to connect the signal generator to your local area network (LAN).

### 2. Configure network parameters

Configure the network parameters of the signal generator according to "To Set the LAN Parameters".

### 3. Search for the device resource

Start up Ultra Sigma and click **LAN**. The window as shown in figure (a) is displayed. Click **Search** and the software searches for the instrument resources currently connected to the LAN and the resources found are displayed at the right section of the window as shown in figure (b). Click **OK** to add it.



(a)

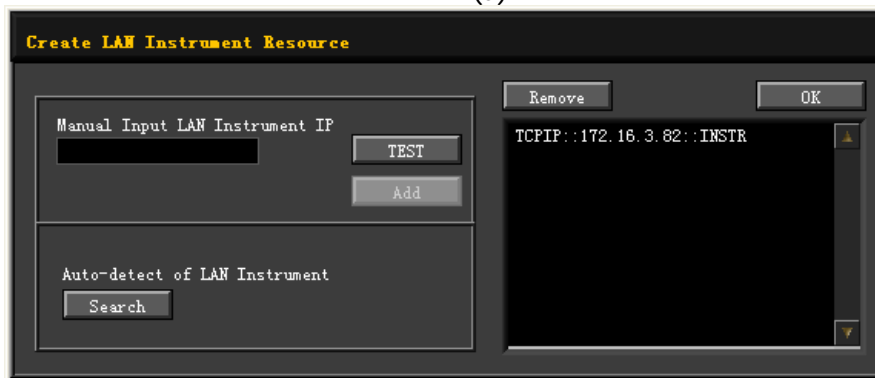

(b)

#### 4. View the device resource

The resources found are shown under the "RIGOL Online Resource" directory. For example, DG832 (TCPIP::172.16.3.82::INSTR).

#### 5. Communication test

Right-click the resource name "DG832 (TCPIP::172.16.3.82::INSTR)" and select "SCPI Panel Control" to turn on the remote command control panel, through which you can send commands and read data.

# Remote Control via GPIB

## 1. Connect the device

Connect the generator to your computer by using a USB-GPIB interface converter.

**Note:** Please make sure that a GPIB card has been installed to your PC. Connect the USB terminal of the USB-GPIB interface converter to the USB HOST interface on the rear panel of the generator. Connect its GPIB terminal to the GPIB card terminal of the PC.

## 2. Install the driver of GPIB card

Correctly install the driver of the GPIB card which has been connected to the PC.

## 3. Set the GPIB address

Press **Utility** → **Interface** → **GPIB** set the GPIB address of the generator.

## 4. Search for the device resource

Start up the Ultra Sigma and click **GPIB** to open the GPIB resource search panel as shown in figure (a). Click "Search" and the software will search the GPIB instrument resources connected to the PC. The device resources found will be displayed on the right side of the panel as shown in figure (b). Click "OK" to add the resource.

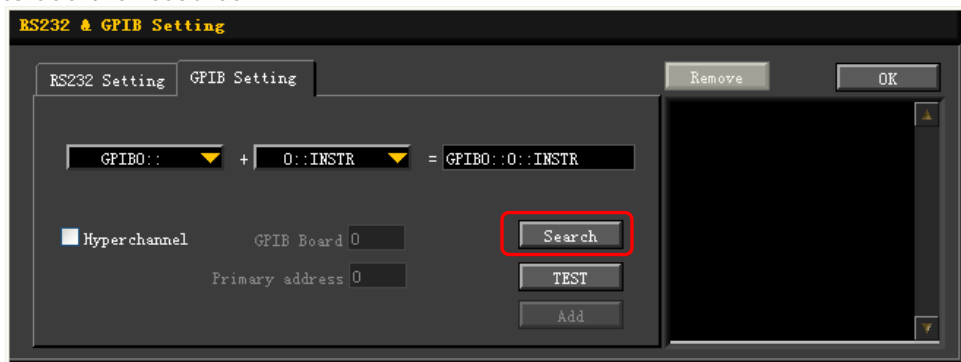

(a)

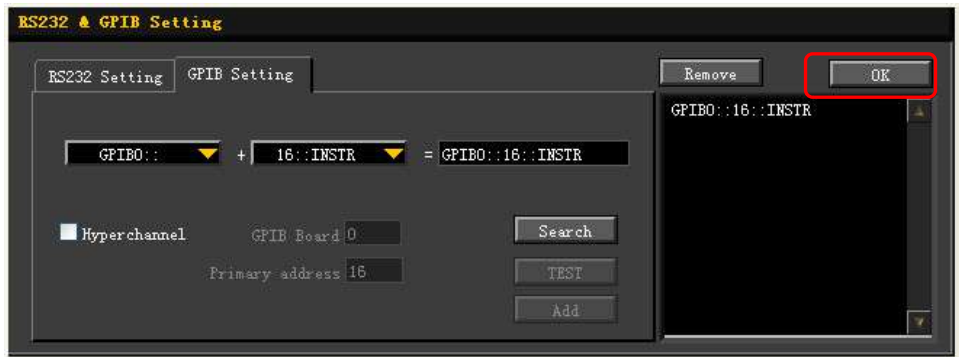

(b)

**If the resource cannot be searched automatically:**

- Select the GPIB card address of the PC from the drop-down box of "GPIB0::" and select the GPIB address set in the signal generator from the drop-down box of "0::INSTR".
- Click "Test" to check whether the GPIB communication works normally. If not, please follow the corresponding prompt messages to solve the problem.

**5. View the device resource**

Click  to go back to the main interface of Ultra Sigma. The GPIB resources found will appear under the "RIGOL Online Resource" directory. For example, DG832 (GPIB0::16::INSTR).

**6. Communication test**

Right-click the resource name "DG832 (GPIB0::16::INSTR)", and select "SCPI Panel Control" to open the remote command control panel. Then you can send commands and read data through the panel.



# Chapter 4 Troubleshooting

The commonly encountered failures of DG800 and their solutions are listed below. If the following problems occur, locate and resolve the problems according to the following steps. If the problems still persist, contact **RIGOL** and provide your instrument information to us. (For instrument information, press **Utility** → **System Info**.)

1. **When I power on the instrument, the instrument stays black and does not display anything.**
  - 1) Check whether the power is correctly connected.
  - 2) Check whether the power key is really pressed.
  - 3) Restart the instrument after finishing the above inspections.
  - 4) If the problem still persists, please contact **RIGOL**.
  
2. **The screen is too dark to see the contents on the screen clearly.**
  - 1) Check whether the brightness settings is too low.
  - 2) Press **Utility** → **DispSet** to enter the display setting menu. Tap the **Brightness** menu label and use the numeric keypad to adjust the brightness of the screen to an optimal state. You can also use the arrow keys and the knob to adjust the brightness.
  
3. **The generator is locked.**
  - 1) Check whether the generator is working in remote mode (in remote mode,  is displayed in the status bar of the user interface). Press **Help/Local** to exit the remote control mode, unlock the front panel and the touch screen.
  - 2) Restarting the generator can also unlock the generator.
  
4. **The settings are correct but no waveform is generated.**
  - 1) Check whether the BNC cable is connected to the corresponding channel output terminal (**[CH1]** or **[CH2]**) tightly.
  - 2) Check whether the BNC cable has internal damage.
  - 3) Check whether the BNC cable is connected to the test instrument tightly.
  - 4) Check whether the backlight of **Output1** or **Output2** is turned on. If not, press the corresponding key to illuminate the backlight.
  - 5) After finishing the above inspections, press **Utility** → **System Setting** → **Power-on** to select "Last" and then restart the instrument.
  - 6) If the problem still persists, please contact **RIGOL**.
  
5. **The USB storage device cannot be recognized.**
  - 1) Check whether the USB storage device can work normally when connected to other instruments or PC.
  - 2) Make sure that the USB storage device is FAT32 format and flash type. The generator doesn't support hardware USB storage device.

- 3) After restarting the instrument, insert the USB storage device again to check whether it can work normally.
- 4) If the USB storage device still cannot work normally, please contact RIGOL.

## 6. How do you set the amplitude of the waveform in dBm?

- 1) Select the desired channel.
- 2) In the channel setting interface, check whether **OutputSet** → **HighZ** is set to "On". If yes, you cannot set the amplitude of the waveform in dBm at this time. Select "Off" to disable the HighZ, and use the numeric keypad, the arrow keys, and knob to set it to a proper value.
- 3) Select the desired waveform, tap the **Ampl** menu label, and then input the desired value by using the numeric keypad. Then select the unit "dBm" from the pop-up menu.

## 7. Performance verification test is failed.

- 1) Check whether the generator is within calibration period (1 year).
- 2) Check whether the generator has been warmed up for at least 30 minutes before the test.
- 3) Check whether the generator is under the specified temperature.
- 4) Check whether the test is under strong-magnetism environment.
- 5) Check whether the power supplies of the generator and test system have a strong interference.
- 6) Check whether the performance of the test device used meets the requirement.
- 7) Make sure that the test device used is within the calibration period.
- 8) Check whether the test devices used meets the required conditions of the manual.
- 9) Check whether all the connections are tight.
- 10) Check whether any cable has internal damage.
- 11) Make sure that the operations conform to settings and processes which are required by the performance verification manual.
- 12) Check whether the error calculation has faults.
- 13) Correctly understand the definition of "typical value" for this product: the performance specification of this product under specified conditions.



## Chapter 5 Appendix

### Appendix A: Accessories and Options

|                             | Description  | Order No.         |
|-----------------------------|--|-------------------|
| <b>Model</b>                | DG812 (10 MHz, Dual-channel)                                       | DG812             |
|                             | DG822 (25MHz, Dual-channel)  | DG822             |
|                             | DG832 (35MHz, Dual-channel)  | DG832             |
|                             | DG811 (10MHz, Single-channel)                                      | DG811             |
|                             | DG821 (25MHz, Single-channel)                                      | DG821             |
|                             | DG831 (35MHz, Single-channel)                                      | DG831             |
| <b>Standard Accessories</b> | 1 Power Cord conforming to the standard of the destination country | -                 |
|                             | 1 BNC Cable (only provided by DG832/DG831/DG822/DG821)             | CB-BNC-BNC-MM-100 |
|                             | 1 Quick Guide  | -                 |
|                             | 1 Product Warranty Card  | -                 |
| <b>Option</b>               | Single-dual CH Upgrade Option (only for DG831/DG821/DG811)         | DG800-DCH         |
|                             | Memory Depth Upgrade Option  | DG800-ARB8M       |
| <b>Optional Accessories</b> | 40 dB Attenuator   | RA5040K           |
|                             | USB-GPIB Interface Converter                                       | USB-GPIB-L        |
|                             | USB-LAN Interface Converter  | USB-LAN           |

## Appendix B: Warranty

**RIGOL** (SUZHOU) TECHNOLOGIES INC. (hereinafter referred to as **RIGOL**) warrants that the product will be free from defects in materials and workmanship within the warranty period. If a product proves defective within the warranty period, **RIGOL** guarantees free replacement or repair for the defective product.

To get repair service, please contact with your nearest **RIGOL** sales or service office.

There is no other warranty, expressed or implied, except such as is expressly set forth herein or other applicable warranty card. There is no implied warranty of merchantability or fitness for a particular purpose. Under no circumstances shall **RIGOL** be liable for any consequential, indirect, ensuing, or special damages for any breach of warranty in any case.

# Index

|                                  |       |                                     |      |
|----------------------------------|-------|-------------------------------------|------|
| *.RAF .....                      | 2-74  | Harmonic Phase .....                | 2-25 |
| *.RSF .....                      | 2-74  | Harmonic Type .....                 | 2-24 |
| Align Phase .....                | 2-14  | High Frequency Rejection.....       | 2-72 |
| AM .....                         | 2-34  | Idle Level .....                    | 2-66 |
| Amplitude .....                  | 2-5   | Infinite Burst.....                 | 2-64 |
| Amplitude Coupling .....         | 2-86  | Linear Sweep .....                  | 2-56 |
| Arb File .....                   | 2-74  | Log Sweep.....                      | 2-57 |
| ASK .....                        | 2-44  | Manual configuration .....          | 2-94 |
| AutoIP .....                     | 2-93  | Marker Freq .....                   | 2-61 |
| Bmp File .....                   | 2-74  | Modulation Depth .....              | 2-36 |
| Built-in Waveform .....          | 2-18  | Modulation Polarity .....           | 2-46 |
| Burst .....                      | 2-63  | N Cycle .....                       | 2-63 |
| Burst Delay .....                | 2-65  | Network Status .....                | 2-93 |
| Burst Period .....               | 2-66  | Output Setting .....                | 2-81 |
| Carrier Waveform Suppression ... | 2-37  | Paste a File .....                  | 2-78 |
| Center Frequency .....           | 2-59  | Phase Coupling .....                | 2-86 |
| Channel Copy .....               | 2-102 | Phase Dev .....                     | 2-43 |
| Clock Source .....               | 2-91  | PM.....                             | 2-41 |
| Copy files.....                  | 2-77  | Print.....                          | 2-97 |
| Coupling .....                   | 2-71  | PSK.....                            | 2-50 |
| Csv File.....                    | 2-74  | Pulse.....                          | 2-11 |
| DC Offset .....                  | 2-7   | PWM.....                            | 2-53 |
| Default Gateway .....            | 2-95  | Return Time.....                    | 2-58 |
| Delete .....                     | 2-78  | RisEdge.....                        | 2-12 |
| DHCP.....                        | 2-93  | Seamless Interconnection .....      | 2-79 |
| DNS .....                        | 2-95  | Self-define the Splash Screen ..... | 2-96 |
| Duty Cycle .....                 | 2-9   | Sensitivity.....                    | 2-71 |
| factory defaults.....            | 2-98  | Start Freq.....                     | 2-59 |
| FallEdge.....                    | 2-12  | Start Hold.....                     | 2-62 |
| FM .....                         | 2-38  | Start Phase.....                    | 2-8  |
| Freq Dev.....                    | 2-39  | State File.....                     | 2-74 |
| Frequency.....                   | 2-4   | Statistical Function .....          | 2-70 |
| Frequency Counter.....           | 2-69  | Step Sweep .....                    | 2-57 |
| Frequency Coupling .....         | 2-85  | Stop Freq .....                     | 2-59 |
| Frequency Span.....              | 2-59  | Stop Hold .....                     | 2-62 |
| FSK .....                        | 2-47  | Subnet mask.....                    | 2-94 |
| Gate Time.....                   | 2-70  | Sweep.....                          | 2-56 |
| Gated Burst.....                 | 2-65  | Sweep Time.....                     | 2-58 |
| Gated Polarity.....              | 2-68  | Sweep Trigger Source .....          | 2-60 |
| GPIB address.....                | 2-92  | Symmetry.....                       | 2-10 |
| Harmonic .....                   | 2-23  | Synchronous Output .....            | 2-83 |
| Harmonic Amplitude.....          | 2-25  | Track.....                          | 2-88 |
| Harmonic Order .....             | 2-24  | USB HOST .....                      | 1-9  |

VISA Address ..... 2-94  
Waveform Combination ..... 2-89

Width Deviation ..... 2-55