

RIGOL

User's Guide

DG5000 Series

Function/Arbitrary Waveform Generator

Dec. 2014

RIGOL Technologies, Inc.

Guaranty and Declaration

Copyright

© 2010 RIGOL Technologies, Inc. All Rights Reserved.

Trademark Information

RIGOL is a registered trademark of RIGOL Technologies, Inc.

Publication Number

UGB07110-1110

Software Version

00.01.10

Software upgrade might change or add product features. Please acquire the latest version of the manual from **RIGOL** website or contact **RIGOL** to upgrade the software.

Notices

- **RIGOL** products are covered by P.R.C. and foreign patents, issued and pending.
- **RIGOL** reserves the right to modify or change parts of or all the specifications and pricing policies at company's sole decision.
- Information in this publication replaces all previously corresponding material.
- Information in this publication is subject to change without notice.
- **RIGOL** shall not be liable for either incidental or consequential losses in connection with the furnishing, use or performance of this manual as well as any information contained.
- Any part of this document is forbidden to be copied, photocopied or rearranged without prior written approval of **RIGOL**.

Product Certification

RIGOL guarantees this product conforms to the national and industrial standards in China as well as the ISO9001:2008 standard and the ISO14001:2004 standard. Other international standard conformance certification is in progress.

Contact Us

If you have any problem or requirement when using our products or this manual, please contact **RIGOL**.

E-mail: service@rigol.com

Websites: www.rigol.com

Safety Requirement

General Safety Summary

Please review the following safety precautions carefully before putting the instrument into operation so as to avoid any personal injury or damage to the instrument and any product connected to it. To prevent potential hazards, please use the instrument only specified by this manual.

Use Proper Power Cord.

Only the power cord designed for the instrument and authorized for use within the local country could be used.

Ground the Instrument.

The instrument is grounded through the Protective Earth lead of the power cord. To avoid electric shock, it is essential to connect the earth terminal of the power cord to the Protective Earth terminal before connecting any inputs or outputs.

Connect the Probe Correctly.

If a probe is used, do not connect the ground lead to high voltage since it has isobaric electric potential as the ground.

Observe All Terminal Ratings.

To avoid fire or shock hazard, observe all ratings and markers on the instrument and check your manual for more information about ratings before connecting the instrument.

Use Proper Overvoltage Protection.

Make sure that no overvoltage (such as that caused by a thunderstorm) can reach the product, or else the operator might be exposed to the danger of electrical shock.

Do Not Operate Without Covers.

Do not operate the instrument with covers or panels removed.

Do Not Insert Anything Into the Holes of Fan.

Do not insert anything into the holes of the fan to avoid damaging the instrument.

Use Proper Fuse.

Please use the specified fuses.

Avoid Circuit or Wire Exposure.

Do not touch exposed junctions and components when the unit is powered.

Do Not Operate With Suspected Failures.

If you suspect damage occurs to the instrument, have it inspected by **RIGOL** authorized personnel before further operations. Any maintenance, adjustment or replacement especially to circuits or accessories must be performed by **RIGOL** authorized personnel.

Keep Well Ventilation.

Inadequate ventilation may cause an increase of instrument temperature which would cause damage to the instrument. So please keep the instrument well ventilated and inspect the intake and fan regularly.

Do Not Operate in Wet Conditions.

In order to avoid short circuiting to the interior of the device or electric shock, please do not operate the instrument in a humid environment.

Do Not Operate in an Explosive Atmosphere.

In order to avoid damage to the device or personal injuries, it is important to operate the device away from an explosive atmosphere.

Keep Product Surfaces Clean and Dry.

To avoid the influence of dust and/or moisture in the air, please keep the surface of the device clean and dry.

Electrostatic Prevention.

Operate the instrument in an electrostatic discharge protective environment to avoid damage induced by static discharges. Always ground both the internal and external conductors of cables to release static before making connections.

Proper Use of Battery.

If a battery is supplied, it must not be exposed to high temperature or in contact with fire. Keep it out of the reach of children. Improper change of battery (note: lithium battery) may cause explosion. Use **RIGOL** specified battery only.

Handling Safety.

Please handle with care during transportation to avoid damage to buttons, knob interfaces and other parts on the panels.

Safety Terms and Symbols

Terms Used in this Manual. These terms may appear in this manual:



WARNING

Warning statements indicate conditions or practices that could result in injury or loss of life.



CAUTION

Caution statements indicate conditions or practices that could result in damage to this product or other property.

Terms Used on the Product. These terms may appear on the product:

DANGER It calls attention to an operation, if not correctly performed, could result in injury or hazard immediately.

WARNING It calls attention to an operation, if not correctly performed, could result in potential injury or hazard.

CAUTION It calls attention to an operation, if not correctly performed, could result in damage to the product or other devices connected to the product.

Symbols Used on the Product. These symbols may appear on the product:



**Hazardous
Voltage**



**Safety
Warning**



**Protective
Earth
Terminal**



**Chassis
Ground**



**Test
Ground**

Allgemeine Sicherheits Informationen

Überprüfen Sie die folgenden Sicherheitshinweise sorgfältig um Personenschäden oder Schäden am Gerät und an damit verbundenen weiteren Geräten zu vermeiden. Zur Vermeidung von Gefahren, nutzen Sie bitte das Gerät nur so, wie in diesem Handbuch angegeben.

Um Feuer oder Verletzungen zu vermeiden, verwenden Sie ein ordnungsgemäßes Netzkabel.

Verwenden Sie für dieses Gerät nur das für ihr Land zugelassene und genehmigte Netzkabel.

Erden des Gerätes.

Das Gerät ist durch den Schutzleiter im Netzkabel geerdet. Um Gefahren durch elektrischen Schlag zu vermeiden, ist es unerlässlich, die Erdung durchzuführen. Erst dann dürfen weitere Ein- oder Ausgänge verbunden werden.

Anschluss eines Tastkopfes.

Die Erdungsklemmen der Sonden sind auf dem gleichen Spannungspegel des Instruments geerdet. Schließen Sie die Erdungsklemmen an keine hohe Spannung an.

Beachten Sie alle Anschlüsse.

Zur Vermeidung von Feuer oder Stromschlag, beachten Sie alle Bemerkungen und Markierungen auf dem Instrument. Befolgen Sie die Bedienungsanleitung für weitere Informationen, bevor Sie weitere Anschlüsse an das Instrument legen.

Verwenden Sie einen geeigneten Überspannungsschutz.

Stellen Sie sicher, daß keinerlei Überspannung (wie z.B. durch Gewitter verursacht) das Gerät erreichen kann. Andernfalls besteht für den Anwender die Gefahr eines Stromschlages.

Nicht ohne Abdeckung einschalten.

Betreiben Sie das Gerät nicht mit entfernten Gehäuse-Abdeckungen.

Betreiben Sie das Gerät nicht geöffnet.

Der Betrieb mit offenen oder entfernten Gehäuseteilen ist nicht zulässig. Nichts in entsprechende Öffnungen stecken (Lüfter z.B.)

Passende Sicherung verwenden.

Setzen Sie nur die spezifikationsgemäßen Sicherungen ein.

Vermeiden Sie ungeschützte Verbindungen.

Berühren Sie keine unisolierten Verbindungen oder Baugruppen, während das Gerät in Betrieb ist.

Betreiben Sie das Gerät nicht im Fehlerfall.

Wenn Sie am Gerät einen Defekt vermuten, sorgen Sie dafür, bevor Sie das Gerät wieder betreiben, dass eine Untersuchung durch **RIGOL** autorisiertem Personal durchgeführt wird. Jedwede Wartung, Einstellarbeiten oder Austausch von Teilen am Gerät, sowie am Zubehör dürfen nur von **RIGOL** autorisiertem Personal durchgeführt werden.

Belüftung sicherstellen.

Unzureichende Belüftung kann zu Temperaturanstiegen und somit zu thermischen Schäden am Gerät führen. Stellen Sie deswegen die Belüftung sicher und kontrollieren regelmäßig Lüfter und Belüftungsöffnungen.

Nicht in feuchter Umgebung betreiben.

Zur Vermeidung von Kurzschluß im Geräteinneren und Stromschlag betreiben Sie das Gerät bitte niemals in feuchter Umgebung.

Nicht in explosiver Atmosphäre betreiben.

Zur Vermeidung von Personen- und Sachschäden ist es unumgänglich, das Gerät ausschließlich fernab jedweder explosiven Atmosphäre zu betreiben.

Geräteoberflächen sauber und trocken halten.

Um den Einfluß von Staub und Feuchtigkeit aus der Luft auszuschließen, halten Sie bitte die Geräteoberflächen sauber und trocken.

Schutz gegen elektrostatische Entladung (ESD).

Sorgen Sie für eine elektrostatisch geschützte Umgebung, um somit Schäden und Funktionsstörungen durch ESD zu vermeiden. Erden Sie vor dem Anschluß immer Innen- und Außenleiter der Verbindungsleitung, um statische Aufladung zu entladen.

Die richtige Verwendung des Akku.

Wenn eine Batterie verwendet wird, vermeiden Sie hohe Temperaturen bzw. Feuer

ausgesetzt werden. Bewahren Sie es außerhalb der Reichweite von Kindern auf. Unsachgemäße Änderung der Batterie (Anmerkung: Lithium-Batterie) kann zu einer Explosion führen. Verwenden Sie nur von **RIGOL** angegebenen Akkus.

Sicherer Transport.

Transportieren Sie das Gerät sorgfältig (Verpackung!), um Schäden an Bedienelementen, Anschlüssen und anderen Teilen zu vermeiden.

Sicherheits Begriffe und Symbole

Begriffe in diesem Guide. Diese Begriffe können in diesem Handbuch auftauchen:



WARNING

Die Kennzeichnung WARNING beschreibt Gefahrenquellen die leibliche Schäden oder den Tod von Personen zur Folge haben können.



CAUTION

Die Kennzeichnung Caution (Vorsicht) beschreibt Gefahrenquellen die Schäden am Gerät hervorrufen können.

Begriffe auf dem Produkt. Diese Bedingungen können auf dem Produkt erscheinen:

DANGER weist auf eine Verletzung oder Gefährdung hin, die sofort geschehen kann.

WARNING weist auf eine Verletzung oder Gefährdung hin, die möglicherweise nicht sofort geschehen.

CAUTION weist auf eine Verletzung oder Gefährdung hin und bedeutet, dass eine mögliche Beschädigung des Instruments oder anderer Gegenstände auftreten kann.

Symbole auf dem Produkt. Diese Symbole können auf dem Produkt erscheinen:



Gefährliche
Spannung



Sicherheits-
Hinweis



Schutz-erde



Gehäusemasse



Erde

General Care and Cleaning

General Care

Do not store or leave the instrument where it may be exposed to direct sunlight for long periods of time.

Cleaning

Clean the instrument regularly according to its operating conditions. To clean the exterior surface, perform the following steps:

1. Disconnect the instrument from all power sources.
2. Clean the loose dust on the outside of the instrument with a lint-free cloth (with a mild detergent or water). When cleaning the LCD, take care to avoid scarifying it.



CAUTION

To avoid damage to the instrument, do not expose it to caustic liquids.



WARNING

To avoid short-circuit and personal injury resulting from moisture, make sure the instrument is completely dry before reconnecting it to power supply.

Environmental Considerations

The following symbol indicates that this product complies with the WEEE Directive 2002/96/EC.



Product End-of-Life Handling

The equipment may contain substances that could be harmful to the environment or human health. In order to avoid the release of such substances into the environment and harm to human health, we encourage you to recycle this product in an appropriate system that will ensure that most of the materials are reused or recycled appropriately. Please contact your local authorities for disposal or recycling information.

DG5000 Series Overview

DG5000 is a multifunctional generator that combines many functions in one, including Function Generator, Arbitrary Waveform Generator, IQ Baseband Source/IQ IF Source, Frequency Hopping Source (optional) and Pattern Generator (optional). It provides single and dual-channel models. The dual-channel model, with two channels having complete equivalent functions and precisely adjustable phase deviation between the two channels, is a real dual-channel signal generator.

DG5000, adopting the Direct Digital Synthesizer (DDS) technology, can provide stable, precise, pure and low distortion signal. The user-friendly interface design and panel layout bring users exceptional experience. Besides, the remote control of the generator can be easily done through different standard configuration interfaces, which provides more solutions for users.

Main Features:

- 4.3 inches, 16M true color TFT LCD.
- 350 MHz, 250 MHz, 100 MHz or 70 MHz maximum sine output frequency, 1 GSa/s sample rate, 14 bits resolution.
- Single/dual-channel models. The dual-channel model supports frequency and phase coupling.
- The 16+2 channels digital output module (optional) together with the analog channel can rebuild the more mixed signals in daily practice.
- Support an external power amplifier (optional) that can be configured online.
- Support frequency hopping output (optional) with hopping interval up to 80ns and arbitrary editing of frequency hopping patterns.
- 14 standard waveform functions:
Sine, Square, Ramp, Pulse, Noise, Sinc, Exponential Rise, Exponential Fall, ECG, Gauss, Haversine, Lorentz, Dual Tones and DC.
- Rise/Fall Time of the Pulse could be adjusted separately.
- Enable to edit arbitrary waveform up to 512 kpts and output arbitrary waveforms up to 128 Mpts.
- Support AM, FM, PM, ASK, FSK, PSK and PWM modulations.
- Support user-defined IQ vector signal modulation and IQ baseband/IF source output.
- Support Frequency Sweep and Burst output.
- Abundant I/O: waveform output, synchronous signal output, modulation input,

10 MHz clock input/output, trigger input/output.

- Enable to store and recall waveform data and instrument state, and support versatile file types. Standard configuration with 1 GBytes flash memory.
- Plenty of standard interfaces: double USB Hosts, USB Device, LAN, and GPIB (IEEE-488.2).
- Seamlessly interconnect with **RIGOL** DS1000E series digital oscilloscopes for loading and reappearing waveforms.
- Support USB storage device.
- Support PictBridge printer.
- Provide security lock hole.
- Support remote control through 10/100M Ethernet web.
- Conform to LXI-C instrument standards (Version 1.2).
- Provide Chinese and English built-in help and input methods.
- Provide powerful waveform editing PC software Ultra Station.

Document Overview

Chapter 1 Quick Start

This chapter introduces the front/rear panel, user interface and main functions, as well as announcements during first use of the instrument.

Chapter 2 Basic Waveform Output

This chapter introduces how to output basic waveforms, e.g. Sine, Square etc.

Chapter 3 Arbitrary Waveform Output

This chapter introduces how to output built-in or user-defined waveforms.

Chapter 4 Common Modulation Output

This chapter introduces how to output common modulated waveforms, e.g. AM, FSK, PWM etc.

Chapter 5 IQ Modulation Output

This chapter introduces how to implement IQ modulated waveform output.

Chapter 6 Frequency Sweep Output

This chapter introduces how to generate a frequency Sweep.

Chapter 7 Burst Output

This chapter introduces how to generate a Burst waveform.

Chapter 8 FH Output

This chapter introduces how to implement frequency hopping output.

Chapter 9 Store and Recall

This chapter introduces how to store and recall the waveform data and the instrument state settings.

Chapter 10 Advanced Operations

This chapter introduces the advanced operations of the instrument, including system parameters setting, waveform saving and printing, functions expansion and the remote control interfaces configuration.

Chapter 11 Remote Control

This chapter introduces how to control the instrument through remote mode.

Chapter 12 Troubleshooting

This chapter lists commonly encountered failures that may appear during the use of the generator and their solutions.

Chapter 13 Specifications

This chapter lists the performances and general specifications of the instrument.

Chapter 14 Appendix

This chapter provides the information about the options and accessories, as well as other points for attention.

Format Conventions in this Manual

1. Buttons:

The function key at the front panel is denoted by the format of "Text Box + Button Name (Bold)" in the manual, for example, **Sine**.

2. Menu Softkey:

The menu softkey is denoted by the format of "Character Shading + Menu Word (Bold)" in the manual, for example, **Freq**.

3. Operation Steps:

The next step of the operation is denoted by an arrow "→" in the manual. For example, **Sine** → **Freq** represents pressing the function key **Sine** at the front panel and then pressing the menu softkey **Freq**.

Content Conventions in this Manual

In this manual, DG5352 is taken as an example to illustrate DG5000 series function/arbitrary waveform generator. Unless otherwise noted, the introductions in this manual are applicable to other models.

DG5000 series cover the following models:

Model	Channels	Max. Frequency	Sample Rate
DG5352	2	350 MHz	1 GSa/s
DG5351	1	350 MHz	1 GSa/s
DG5252	2	250 MHz	1 GSa/s
DG5251	1	250 MHz	1 GSa/s
DG5102	2	100 MHz	1 GSa/s
DG5101	1	100 MHz	1 GSa/s
DG5072	2	70MHz	1 GSa/s
DG5071	1	70MHz	1 GSa/s

Contents

Guaranty and Declaration	I
Safety Requirement	II
General Safety Summary.....	II
Safety Terms and Symbols	V
Allgemeine Sicherheits Informationen	VI
Sicherheits Begriffe und Symbole.....	IX
General Care and Cleaning	X
Environmental Considerations.....	XI
DG5000 Series Overview	XII
Document Overview	XIV
Chapter 1 Quick Start	1-1
General Inspection	1-2
Handle Adjustment.....	1-3
Appearance and Dimensions	1-4
Front Panel.....	1-5
Rear Panel.....	1-11
Power on the Generator	1-14
User Interface.....	1-15
Parameter Mode	1-15
Graph Mode	1-15
To Rack Mount the Instrument	1-17
Kit Parts List.....	1-17
Installation Tool.....	1-18
Space Requirements for Installation	1-18
Installation Procedures.....	1-19
To Use the Security Lock.....	1-22
To Use the Built-In Help.....	1-23
Chapter 2 Basic Waveform Output	2-1
To Output Sine Waveform	2-2
To Output Square Waveform	2-5
To Output Ramp Waveform	2-6
To Output Pulse Waveform.....	2-7
To Output Noise Waveform	2-11

Align Phase..... 2-12

Chapter 3 Arbitrary Waveform Output 3-1

To Enable Arbitrary Waveform 3-2

Output Mode..... 3-4

 Normal Mode..... 3-4

 Play Mode 3-5

To Select Arbitrary Waveform 3-6

 Built-In Waveform..... 3-6

 Stored Waveform 3-7

 Volatile Waveform 3-7

To Create New Arbitrary Waveform 3-8

 Edit Points..... 3-11

 Edit Block..... 3-13

To Edit Arbitrary Waveform..... 3-15

Chapter 4 Common Modulation Output 4-1

Amplitude Modulation (AM) 4-2

 To Select AM Modulation..... 4-2

 To Select Carrier Waveform Shape 4-2

 To Set Carrier Frequency 4-2

 To Select Modulating Waveform Source..... 4-3

 To Set Modulating Waveform Frequency..... 4-4

 To Set Modulation Depth 4-4

Frequency Modulation (FM) 4-5

 To Select FM Modulation..... 4-5

 To Select Carrier Waveform Shape 4-5

 To Set Carrier Frequency 4-5

 To Select Modulating Waveform Source..... 4-6

 To Set Modulating Waveform Frequency..... 4-7

 To Set Frequency Deviation..... 4-7

Phase Modulation (PM) 4-8

 To Select PM Modulation..... 4-8

 To Select Carrier Waveform Shape 4-8

 To Set Carrier Frequency 4-8

 To Select Modulating Waveform Source..... 4-9

 To Set Modulating Waveform Frequency..... 4-10

 To Set Phase Deviation..... 4-10

Amplitude Shift Keying (ASK)..... 4-11

To Select ASK Modulation	4-11
To Select Carrier Waveform Shape.....	4-11
To Set Carrier Amplitude.....	4-11
To Select Modulating Waveform Source.....	4-12
To Set ASK Rate	4-12
To Set Modulating Amplitude	4-13
To Set Modulating Polarity	4-13
Frequency Shift Keying (FSK)	4-14
To Select FSK Modulation	4-14
To Select Carrier Waveform Shape.....	4-14
To Set Carrier Frequency	4-15
To Select Modulating Waveform Source.....	4-15
To Set FSK Rate.....	4-16
To Set Hop Frequency.....	4-16
To Set Modulating Polarity	4-16
Phase Shift Keying (PSK)	4-17
To Select PSK Modulation	4-17
To Select Carrier Waveform Shape.....	4-17
To Set Carrier Phase	4-17
To Select Modulating Waveform Source.....	4-18
To Set PSK Rate	4-18
To Set Modulating Phase	4-19
To Set Modulating Polarity	4-19
Pulse Width Modulation (PWM).....	4-20
To Select PWM Modulation.....	4-20
To Select Pulse Waveform.....	4-20
To Set Pulse Width/Duty Cycle	4-20
To Select Modulating Waveform Source.....	4-21
To Set Modulating Waveform Frequency.....	4-22
To Set Pulse Width/Duty Cycle Deviation.....	4-22
Chapter 5 IQ Modulation Output	5-1
IQ Modulation Overview	5-2
To Select IQ Modulation.....	5-3
To Select Carrier Waveform Shape	5-3
To Select Modulating Waveform Source	5-3
To Select Code Pattern.....	5-5
Pre-defined PN Sequence Code Pattern.....	5-5

Pre-defined Fixed 4 bits Code Pattern	5-5
User-defined Code Pattern	5-6
To Set Code Rate.....	5-8
IQ Mapping.....	5-9
Chapter 6 Frequency Sweep Output.....	6-1
To Enable Frequency Sweep.....	6-2
Start Frequency and End Frequency	6-2
Center Frequency and Frequency Span.....	6-3
Sweep Type	6-4
Linear Sweep.....	6-4
Log Sweep	6-5
Step Sweep.....	6-6
Sweep Time.....	6-7
Return Time.....	6-7
Mark Frequency	6-7
Start Hold.....	6-8
End Hold	6-8
Sweep Trigger Source	6-9
Sweep Trigger Output	6-10
Chapter 7 Burst Output	7-1
To Enable Burst Mode	7-2
Burst Type	7-2
N Cycle Burst.....	7-2
Infinite Burst	7-3
Gated Burst.....	7-4
Burst Phase	7-5
Burst Period.....	7-5
Gated Polarity	7-5
Burst Delay.....	7-6
Burst Trigger Source	7-6
Burst Trigger Output	7-7
Chapter 8 FH Output (Option)	8-1
FH Overview	8-2
To Enable FH Function	8-3
To Select Carrier Waveform	8-4
FH Switch	8-4

FH Interval	8-4
Start Point	8-5
Display Type	8-5
To Load Map	8-6
To Edit Map	8-7
FH List	8-7
FH Sequence	8-9
To Save FH Map	8-10
Chapter 9 Store and Recall	9-1
Storage System Overview	9-2
To Select File Type	9-3
To Select Browser Type	9-4
To Save a File	9-4
To Recall a File	9-7
To Copy a File	9-7
To Paste a File	9-8
To Delete a File or Folder	9-8
To Create a New Folder	9-9
Format the Local Disk	9-9
Seamlessly Interconnection	9-10
Chapter 10 Advanced Operation	10-1
Advanced Operation Overview	10-2
Channel Setting	10-3
Sync Setting	10-3
Sync Polarity	10-5
Output Polarity	10-5
Resistance Setting	10-6
Range Setting	10-6
Attenuation Setting	10-7
Enable Freq Hop Function	10-7
Channel Coupling	10-8
Channel Copy	10-10
System Setting	10-11
Number Format	10-11
Language	10-12
Power On Setting	10-12
Restore Default	10-12

Display Setting	10-17
Beep Setting.....	10-18
Screen Saver Setting	10-18
Clock Source Setting	10-19
User-defined Shortcut	10-20
System Information.....	10-20
Print.....	10-21
Test Calibration	10-22
To Use the Power Amplifier (Option)	10-23
To Use the Digital Module (Option).....	10-27
Protocol Setting	10-30
To Set the Code Pattern.....	10-33
User Data Editing.....	10-34
To Set the Output Data Length.....	10-35
Channel Setting	10-36
Trigger Setting.....	10-38
To Install the Option	10-39
To Configure the Remote Interface	10-40
To Set GPIB Address	10-40
LAN Setting	10-40
To Set USB Device Type.....	10-45
Chapter 11 Remote Control.....	11-1
Remote Control Via USB.....	11-2
Remote Control Via LAN	11-4
Remote Control Via GPIB	11-7
Chapter 12 Troubleshooting.....	12-1
Chapter 13 Specifications	13-1
Chapter 14 Appendix	14-1
Appendix A: Option and Accessories.....	14-1
Appendix B: Specifications of Power Amplifier	14-2
Appendix C: Specifications of Digital Module	14-4
Appendix D: Warranty.....	14-6
Index	1

Chapter 1 Quick Start

This chapter introduces the front/rear panel, user interface and main functions, as well as announcements during first use of the instrument.

Subjects in this chapter:

- General Inspection
- Handle Adjustment
- Appearance and Dimensions
- Front Panel
- Rear Panel
- Power on the Generator
- User Interface
- To Rack Mount the Instrument
- To Use the Security Lock
- To Use the Built-In Help

General Inspection

1. **Inspect the shipping container for damage.**

If there are damages in the container or foam, keep them until the whole machine and the accessories passing the electrical and mechanical tests.

If your instrument has damaged during shipping, please contact your shipper and carrier for compensation. **RIGOL** will provide no free repair or replacement.

2. **Inspect the instrument.**

In case of any mechanical damage or defect, or if the instrument does not operate properly or pass the electrical and mechanical tests, contact your local sales representative of **RIGOL**.

3. **Check the Accessories**

If the contents are incomplete or damaged, please contact your local sales representative of **RIGOL**.

Handle Adjustment

To adjust the handle position of the instrument, please grip the handle by sides and pull it outward. Then, rotate the handle to the desired position. The operating method is shown below.

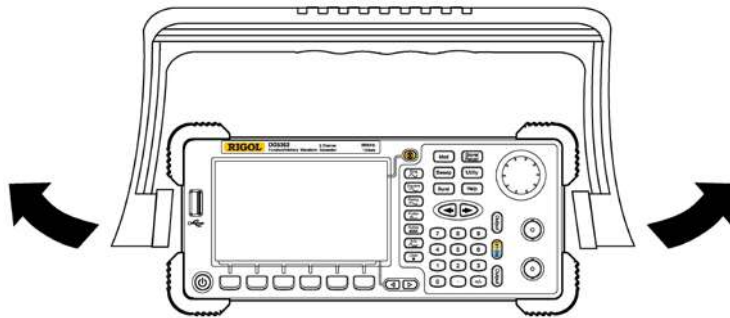

Adjusting the handle

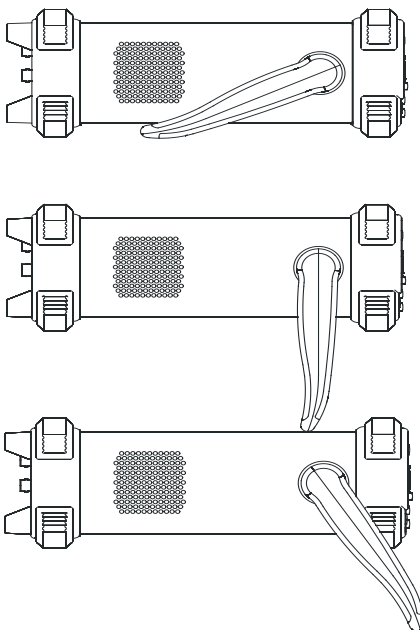

Viewing Positions

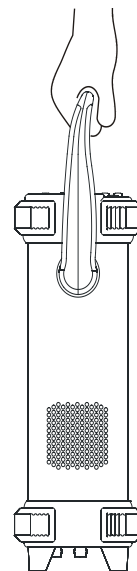

Carrying Position

Appearance and Dimensions

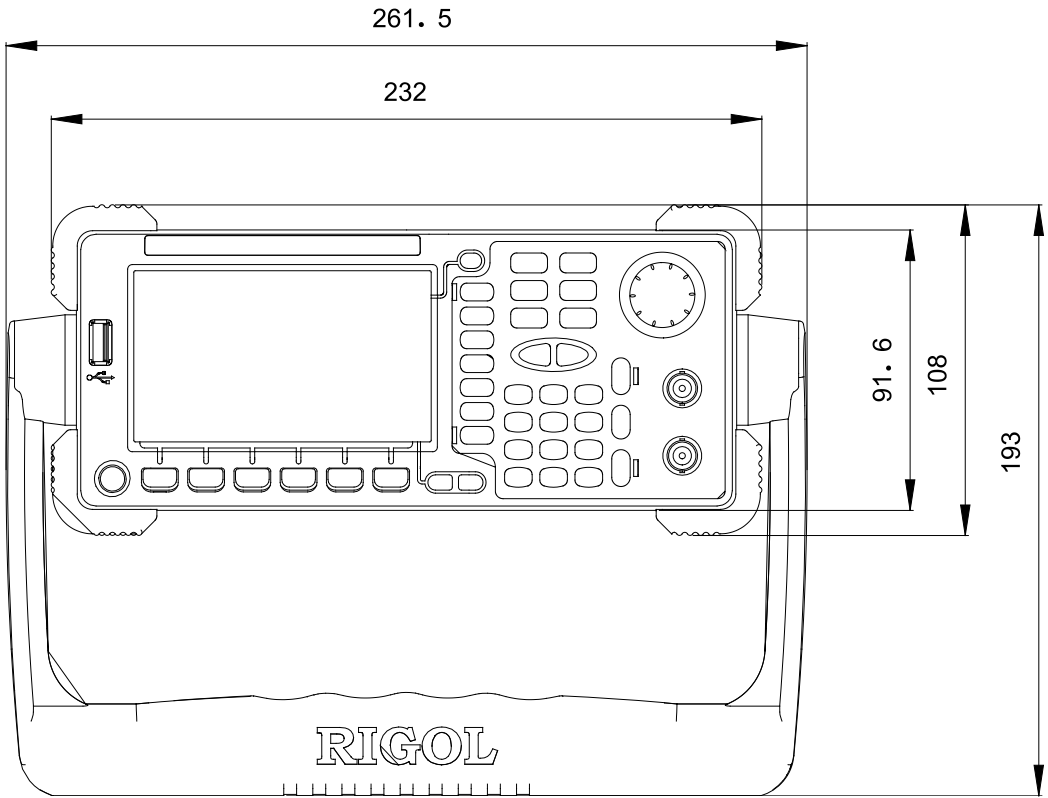

Front Elevation

Unit: mm

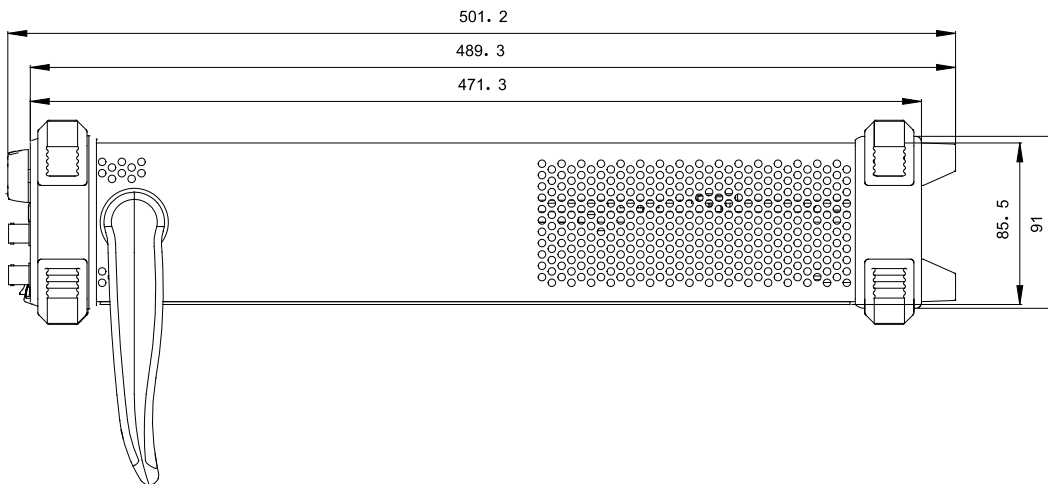

Side Elevation

Unit: mm

Front Panel

The manual illustrates the front panel of the instrument taking the dual-channel model for example.

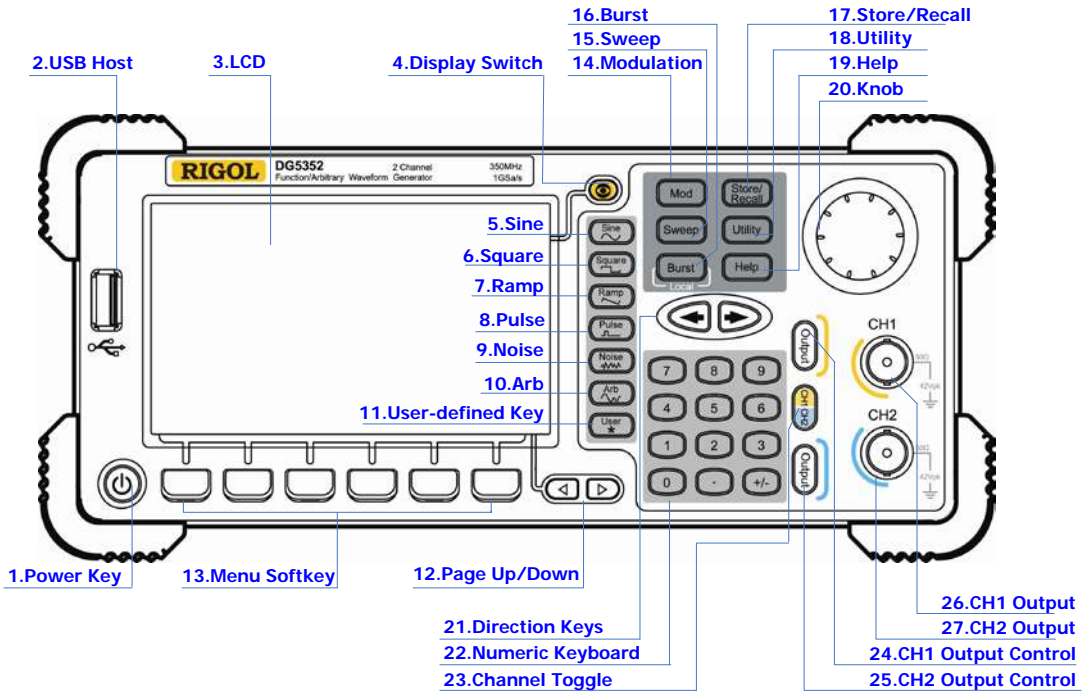

Figure 1-1 Dual-Channel Model Front Panel Overview

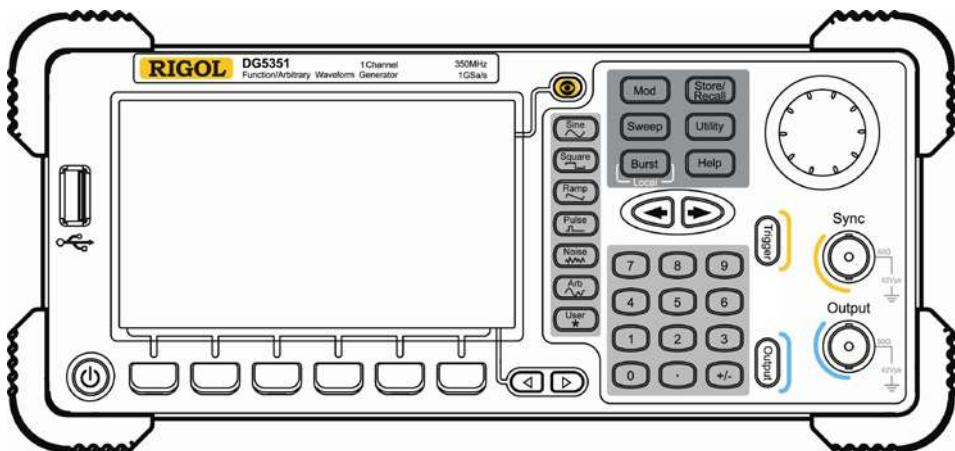

Figure 1-2 Single-Channel Model Front Panel Overview

1. Power Key

The power soft key is used to turn the generator on or off.

2. USB Host

Support USB storage device, **RIGOL** DS1000E series digital oscilloscope (DS) and power amplifier (PA).

- USB storage device: read the waveform or state files from the USB storage device, or store the current instrument state and edited waveform data into the USB storage device.
- DS1000E series DS: seamlessly interconnect with the **RIGOL** DS1000E series DS, read and store the waveform data sampled by the DS and display it nondestructively.
- PA (optional): support the **RIGOL** power amplifier, for example, PA1011. Enable to be configured online and amplify the signal power before output.

3. LCD

480 × 272 TFT color LCD is used to display the current function menu and parameters setting, system state and prompt messages.

4. Display Switch

For dual-channel model: this key is used to switch between Parameter and Graph display modes.

For single-channel model: this key is not available.

5. Sine

Generate a Sine waveform with frequency from 1 μ Hz to 350 MHz.

- When the function is enabled, the backlight of the button turns on.
- Enable to change Frequency/Period, Amplitude/High Level, Offset/Low Level and Start Phase of the Sine waveform.

6. Square

Generate a Square waveform with frequency from 1 μ Hz to 120 MHz and variable duty cycle.

- When the function is enabled, the backlight of the button turns on.
- Enable to change Frequency/Period, Amplitude/High Level, Offset/Low Level, Duty Cycle and Start Phase of the Square waveform.

7. Ramp

Generate a Ramp waveform with frequency from 1 μ Hz to 5 MHz and variable symmetry.

- When the function is enabled, the backlight of the button turns on.
- Enable to change Frequency/Period, Amplitude/High Level, Offset/Low Level, Symmetry and Start Phase of the Ramp waveform.

8. Pulse

Generate a Pulse waveform with frequency from 1 μ Hz to 50 MHz and variable pulse width and edge time.

- When the function is enabled, the backlight of the button turns on.
- Enable to change Frequency/Period, Amplitude/High Level, Offset/Low Level, Pulse Width/Duty Cycle, Leading Edge Time, Trailing Edge Time and Delay of the Pulse waveform.

9. Noise

Generate a Gauss Noise with bandwidth up to 250 MHz.

- When the function is enabled, the backlight of the button turns on.
- Enable to change Amplitude/High Level and Offset/Low Level of the Noise waveform.

10. Arb

Generate an arbitrary waveform with frequency from 1 μ Hz to 50 MHz.

- Provide two output modes: "Normal" and "Play".
- Generate 10 built-in waveforms: DC, Sinc, Exponential Rise, Exponential Fall, ECG, Gauss, Haversine, Lorentz, Pulse and Dual-Tone; generate arbitrary waveforms from USB storage device; generate arbitrary waveforms edited online (512 kpts) or through PC software and then downloaded to the instrument by the users; support wavetable points up to 128 Mpts.
- When the function is enabled, the backlight of the button turns on.
- Enable to change Frequency/Period, Amplitude/High Level, Offset/Low Level and Start Phase of the arbitrary waveform.

11. User-defined Key

For some frequently used menus with "deep" location, users can define them as shortcuts (under the function key **Utility**). And then, in any operation interface, press the **User-defined Key** to quickly open and set your desired menu or function.

12. Page Up/Down

Open the previous or next page of the current function menu.

13. Menu Softkey

Press any softkey to activate the corresponding menu.

14. Modulation

Generate modulated waveforms. Provide versatile common modulations and user defined IQ modulation.

- Common Modulations: support internal and external modulations, generate AM, FM, PM, ASK, FSK, PSK and PWM modulated signal.
- User Defined IQ Modulation: support internal and external modulation, generate IQ modulated signal.

15. Sweep

Generate the frequency sweeping signal of Sine, Square, Ramp and Arbitrary Waveforms (except DC).

- Support three sweep types: Linear, Log and Step.
- Set Start Hold, End Hold and Return Time.
- Provide the "Mark" function.
- When the function is enabled, the backlight of the button turns on.

16. Burst

Generate burst waveforms of Sine, Square, Ramp, Pulse and Arbitrary waveform (except DC).

- Support three burst types: N Cycle, Infinite and Gated.
- Noise can also be used to generate Gated burst.
- When the function is enabled, the backlight of the button turns on.
- In remote mode, press this button to switch to local mode.

17. Store/Recall

Store/recall the instrument state or user-defined arbitrary waveform data.

- Support file management system to execute normal file operations.
- Provide 1 GBytes built-in non-volatile memory (C Disk) and two external USB storage devices (D Disk and E Disk). In addition, files stored in a USB storage device can be copied to C Disk for long-term preservation.
- When the function is enabled, the backlight of the button turns on.

18. Utility

Provide some advanced operations, including system parameters setting, waveform saving and printing, functions expanding and the remote control interfaces configuration.

When the function is enabled, the backlight of the button turns on.

19. Help

To get context help information about any front-panel key or menu softkey, press this key until it is illuminated and then press the desired key.

20. Knob

Be used to increase (clockwise) or decrease (anticlockwise) the current highlighted number. Also can be used to select file location or switch the character of the soft keyboard when entering file name.

21. Direction Keys

Be used to switch the digits of the number, the data page and the file locations.

22. Numeric Keyboard

Consists of numbers (0~9), decimal point (.) and operators (+/-). Notice that, if a negative is required, please input an operator "-" before the numbers. In addition, the decimal point "." also can be used to switch units quickly.

23. Channel Toggle

For dual-channel model: switch and toggle a channel.

For single-channel model: not available.

24. CH1 Output Control

For dual-channel model: control the output of CH1. When the output function enables, the backlight of the button goes on.

For single-channel model: trigger "Sweep" and "Burst" manually.

25. CH2 Output Control

For dual-channel model: control the output of CH2. When the output function enables, the backlight of the button turns on.

For single-channel model: control the output of the main channel. When the output function enables, the backlight of the button turns on.

26. CH1 Output

This BNC connector is used as an output terminal.

For dual-channel model: enable or disable waveform signals generated from [Output] connector corresponding to CH1. The nominal output impedance is 50 Ω .

For single-channel model: output a TTL-compatible pulse synchronized with the main output. The nominal source impedance is 50 Ω .

27. CH2 Output

This BNC connector is used as an output terminal. The nominal output impedance is 50 Ω .

For dual-channel model: enable or disable waveform signals generated from [Output] connector corresponding to CH2.

For single-channel model: output signals of the main channel.



CAUTION

Overvoltage protection of the output channel will take effect once any of the following conditions is met.

- Amplitude setting in the generator is greater than 2 Vpp; the input voltage is greater than ± 12.1 V (± 0.1 V) and frequency is lower than 10 kHz.
- Amplitude setting in the generator is lower than or equal to 2 Vpp; the input voltage is greater than ± 4.8 V (± 0.1 V) and frequency is lower than 10 kHz.

The message "OverLoad protect, The output is off!" will appear on the screen when overvoltage protection takes effect.

Rear Panel

The manual illustrates the rear panel of the instrument taking the dual-channel model for example.

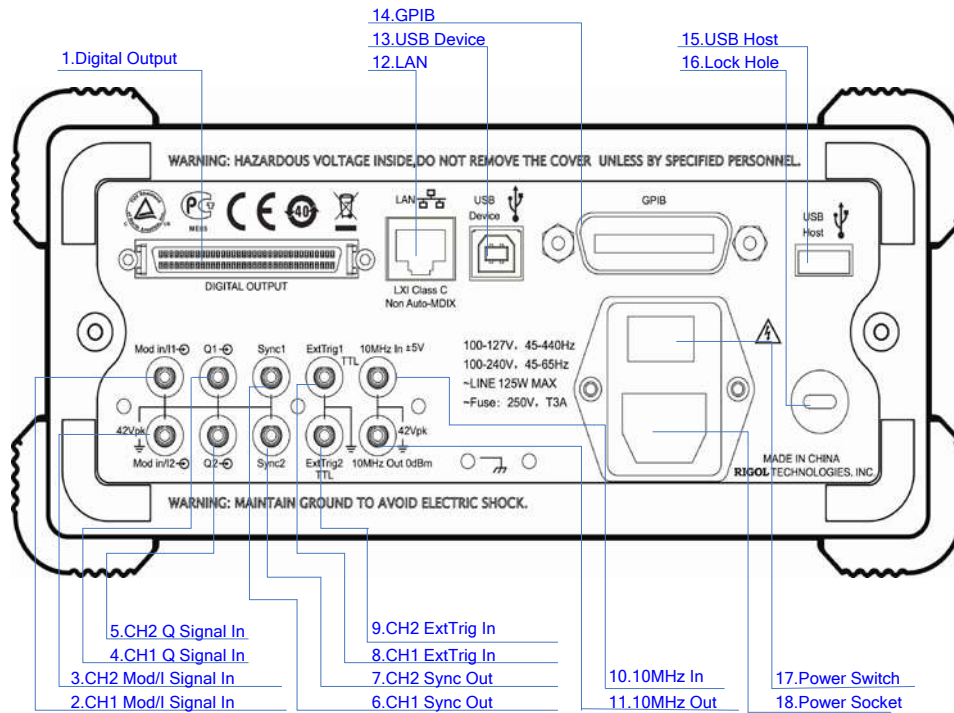

Figure 1-3 Dual-Channel Model Rear Panel Overview

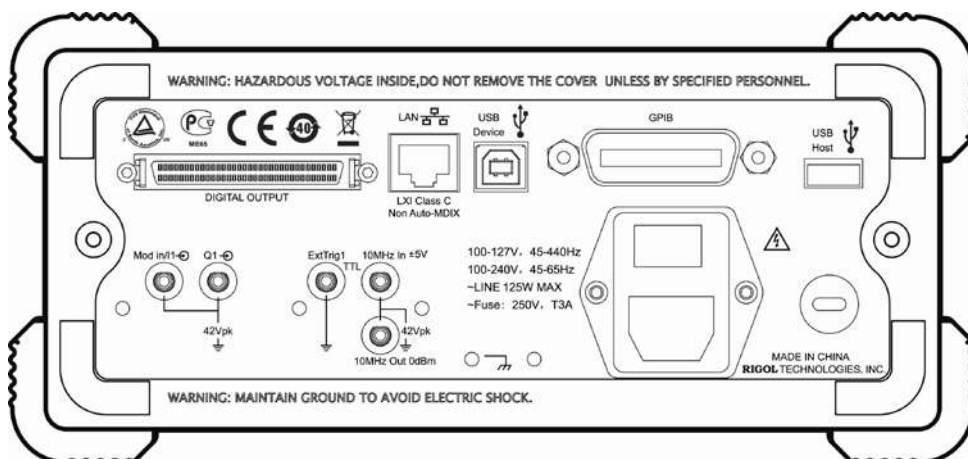

Figure 1-4 Single-Channel Model Rear Panel Overview

1. DIGITAL OUTPUT

Connect the generator with the “logic signal output module” DG-POD-A (optional). Then, configure specific sequence digital signal in the generator and output the signal through the digital module.

2. CH1 Mod/I Signal In (Mod in/I1)

This SMB connector accepts an external Analog modulation signal or In-Phase (I) baseband signal to be used in CH1's modulation. The nominal input impedance is 10 k Ω .

3. CH2 Mod/I Signal In (Mod in/I2)

This SMB connector accepts an external Analog modulation signal or In-Phase (I) baseband signal to be used in CH2's modulation. The nominal input impedance is 10 k Ω .

4. CH1 Q Signal In (Q1)

This SMB connector accepts an external Quadrature Phase (Q) baseband signal to be used in CH1's modulation. The nominal input impedance is 10 k Ω .

5. CH2 Q Signal In (Q2)

This SMB connector accepts an external Quadrature Phase (Q) baseband signal to be used in CH2's modulation. The nominal input impedance is 10 k Ω .

6. CH1 Sync Out (Sync1)

This SMB connector outputs a TTL-compatible pulse synchronized with the output of CH1. The nominal source impedance is 50 Ω .

7. CH2 Sync Out (Sync2)

This SMB connector outputs a TTL-compatible pulse synchronized with the output of CH2. The nominal source impedance is 50 Ω .

8. CH1 ExtTrig In (ExtTrig1)

This SMB connector accepts an external TTL-compatible pulse as the trigger input or external digital modulation signal of CH1. Besides, it can also be used as the trigger out in Sweep and Burst mode.

9. CH2 ExtTrig In (ExtTrig2)

This SMB connector accepts an external TTL-compatible pulse as the trigger input or external digital modulation signal of CH2. Besides, it can also be used as the trigger out in Sweep and Burst mode.

10. (11.) 10MHz In/10MHz Out

These two connectors are used to synchronize generators. The connector [10MHz In] accepts an external 10 MHz clock signal, and the connector [10MHz Out] can output a 10 MHz clock signal generated by the crystal inside the generator.

12. LAN

Through this interface, the generator can be connected to your local network for remote control. An integrated testing system may be built, as the generator conforms to the LXI-C class standard of LAN-based instrument control.

13. USB Device

Through this interface, the generator can be connected to a PictBridge printer to print its screen, or be connected to a PC and controlled via PC software.

14. GPIB

Meet IEEE-488.2 specification.

15. USB Host

Reference to "USB Host" page 1-6.

16. Lock Hole

Use the security lock (please buy it yourself) to lock the generator in fixed location.

17. Power Switch

Connect or cut off the power supply.

18. Power Socket

The generator can accept two types of AC power supply.

AC Power Supply: 45-440 Hz, 100-127 V or 45-60 Hz, 100-240 V.

Power Fuse: 250 V, T3A.

Power Consumption: less than 125 W.

Power on the Generator

Connect the generator to the AC supply by using the supplied power cord, and then perform the following steps.

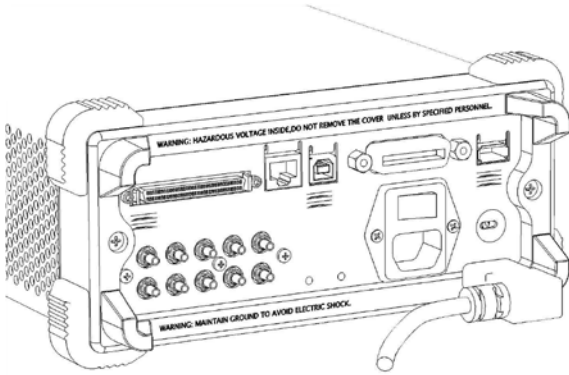

1. Turn on the power of the instrument

Turn on the power switch at the rear panel of the instrument.



WARNING

To avoid electric shock, make sure the instrument has been properly grounded.

2. Start-up the instrument

Press down the power key at the front panel. The instrument starts and executes self-test and then enters the user interface.

User Interface

The user interface is usually shown in two modes which are “Parameter” and “Graphic”. The illustration given here will take the “Graphic” mode of the Dual-Channel Model for example.

Parameter Mode

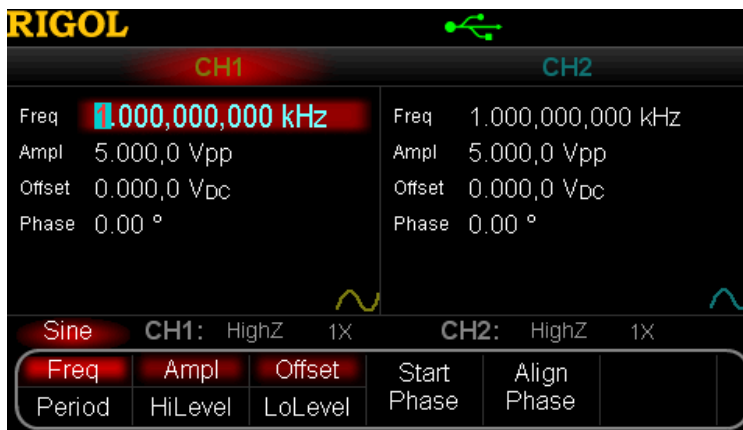

Figure 1-5 User Interface (Parameter Mode)

Graph Mode



In parameter mode, toggle the “Display Switch”  at the upper right of the screen to switch to the Graphic Mode.



Figure 1-6 User Interface (Graphic Mode)

1. Status Bar

Indicate system status. For example, an icon  denotes that a USB storage device has been detected.

2. Current Function

Show the current active function. For example, "Sine" denotes that sine wave has been selected at present.

3. Channel Label Bar

Be divided into two parts which marks the display areas of CH1 and CH2 respectively. The currently selected channel label will be highlighted.

4. Frequency Display

Display the current waveform frequency in each channel. Press corresponding softkey **Freq** and use the numeric keyboard or knob to modify this parameter. The parameter that can be modified currently will be highlighted.

5. Amplitude Display

Display the current waveform amplitude in each channel. Press corresponding softkey **Ampl** and use the numeric keyboard or knob to modify this parameter. The value that can be modified currently will be highlighted.

6. Waveform Display

Display the currently selected waveform shape in each channel. The waveform of the currently selected channel will be highlighted.

7. Output Configuration

Display the current output configuration in each channel, including "Output resistance" and "Attenuation setting".

8. Menu Softkey

Press any softkey to activate the corresponding function.

To Rack Mount the Instrument

This generator can be mounted in a standard 19-inch rack cabinet. Please disassemble the cushioning material and handle before the installation.

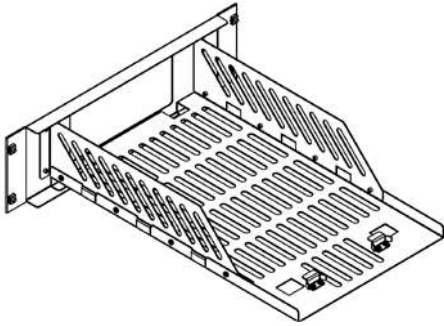

Kit Parts List

No.	Name	Qty.	Part Number	Description
1-1	Front Panel	1	RM-DG-5-01	
1-2	Support Board	1	RM-DG-5-02	
1-3	Left Plate	1	RM-DG-5-03	
1-4	Right Plate	1	RM-DG-5-04	
1-5	Fixed Figure	2	RM-DG-5-05	
2-1	M4 Screw	19	RM-SCREW-01	M4*6 Phil-Slot Pan Head Machine Screw Nail
2-2	M6 Screw	4	RM-SCREW-02	M6*16 Phil-Slot Pan Head Machine Screw Nail
2-3	M6 Nut	4	RM-SCREW-03	M6*5 Square Machine Female Screw Contain Lock Blade

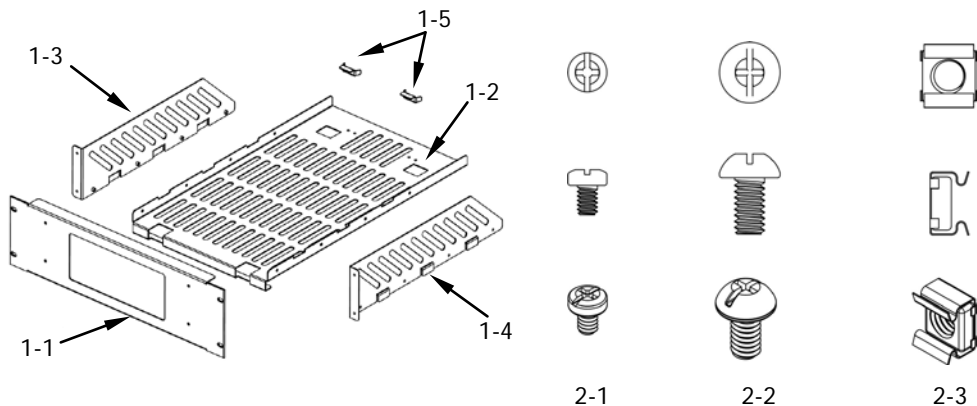

Installation Tool

PH2 Phillips Screwdriver (recommended).

Space Requirements for Installation

The following requirements must be fulfilled by the machine cabinet in which the instrument is mounted.

- Dimension of the machine cabinet must be standard 19-inch.
- At least 3U (133.5 mm) space should be provided by the machine cabinet.
- The depth inside the machine cabinet should not be less than 530 mm.

The dimension of the instrument after being mounted is shown below.

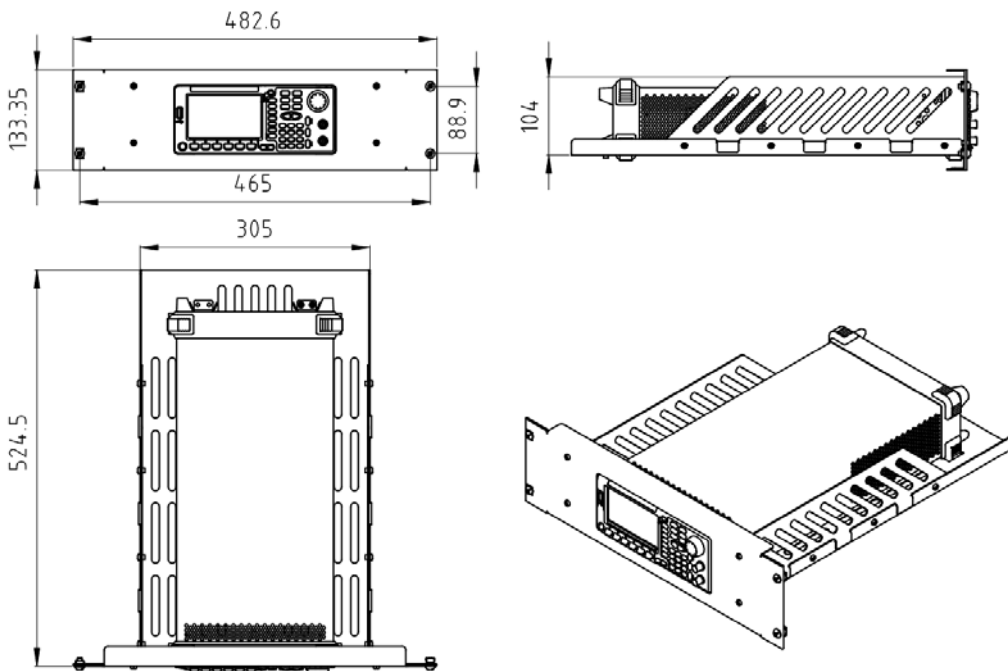

Installation Procedures

Only authorized operators can execute the installation operation. The instrument will be damaged or installed in rack incorrectly if the installation is not proper.

1. Remove the handle: please grip the handle by sides, pull it outward and then upward.

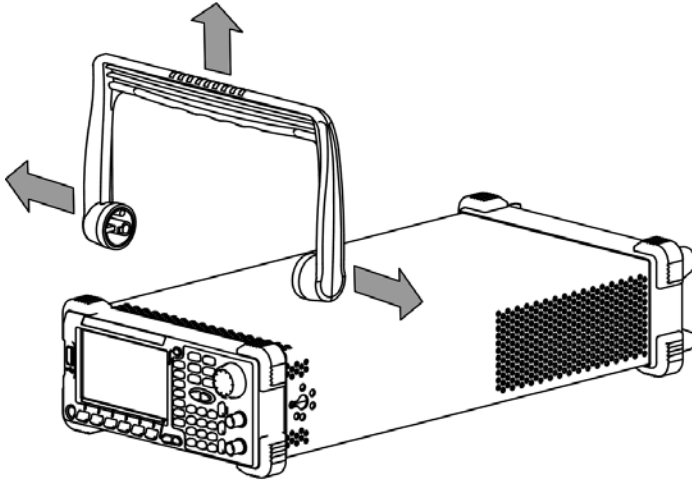

2. Install the right and left plates: align the detents of right and left plates with the openings on the support board and insert them into the support board respectively, then fix them with eight M4 screws.

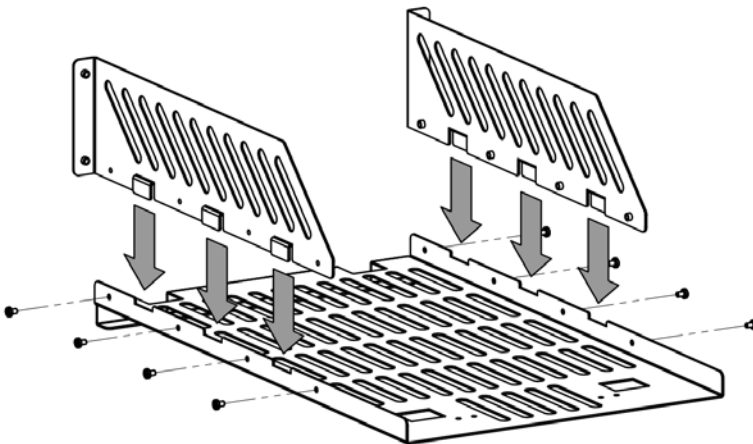

3. Place the instrument: align the protection pads of the instrument with the corresponding holes and then place it on the Support Board.

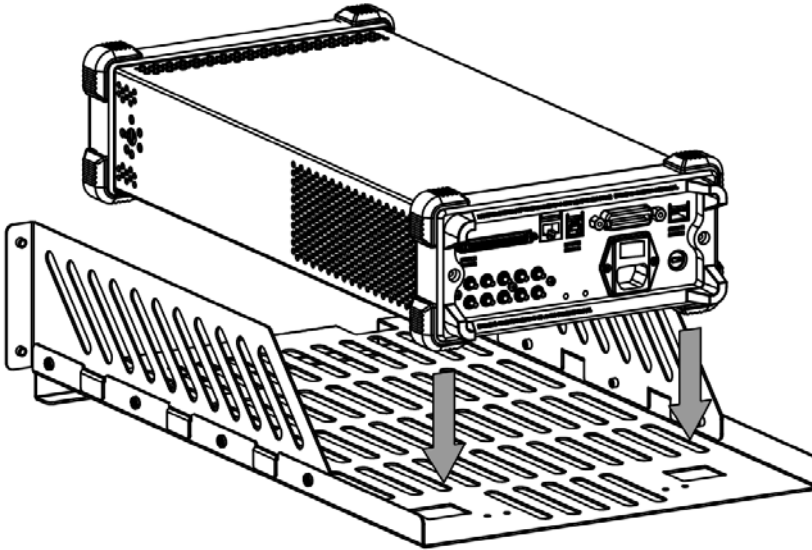

4. Fixed the instrument: fasten the instrument tightly on the Support Board with two Fixed Figures and fixed it with four M4 screws.

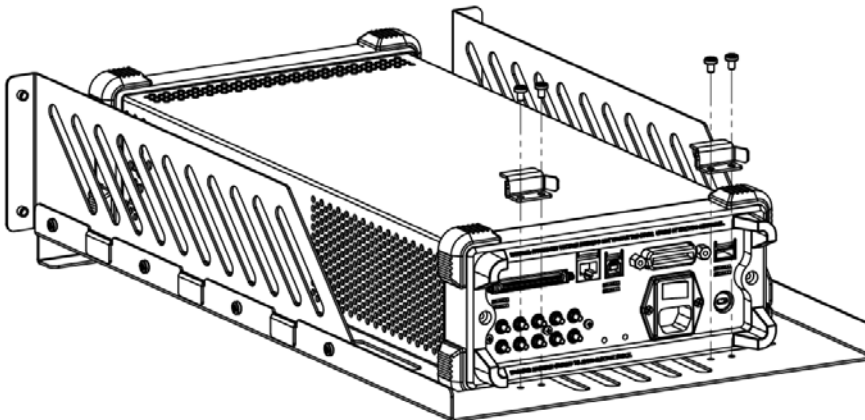

5. Install the Front Panel: aiming the instrument front panel at the opening of the Front Panel of the machine rack and fix them with four M4 screws.

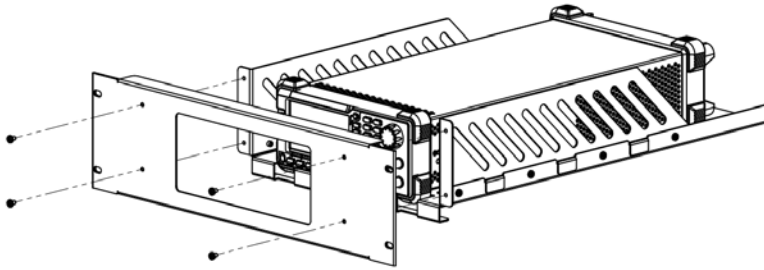

6. Load into the machine cabinet: mount the rack fixed with instrument into a standard 19-inch machine cabinet with four M6 screws and square nuts.

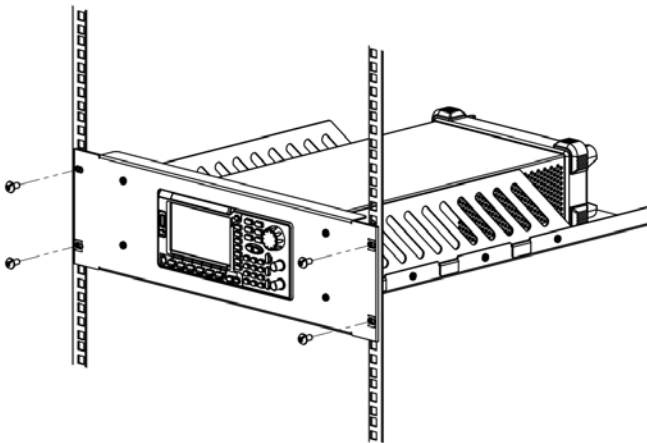

7. Post-installation notice: the rack occupies a height of 3U. The holes pointed out by the arrows are the installation holes. Note that they are aligned while installing.

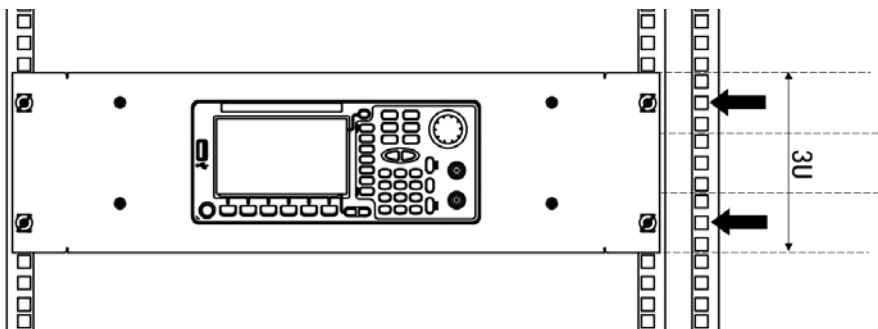

To Use the Security Lock

Use a security lock to lock your generator in a desired location. As shown in the picture below, align the lock with the lock hole on the generator and insert the lock. Turn the key clockwise to lock the instrument and then pull the key out.

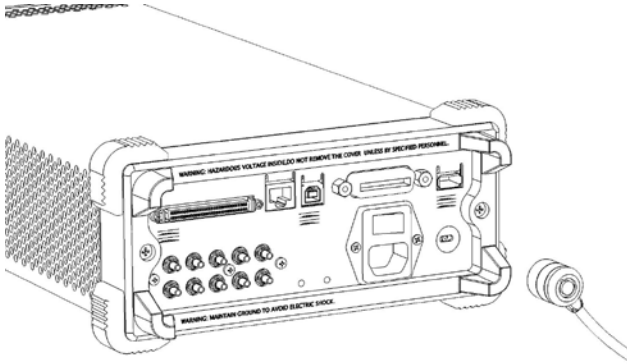

To Use the Built-In Help

To get help information about any front-panel key or menu softkey, press **Help** to illuminate the key and then press the desired key to get the corresponding help information. Pressing **Help** twice will get the following common help information.

1. **View the last displayed message.**
2. **View error queue of the remote commands.**
3. **Get the help information of a key.**
4. **Generate a basic waveform.**
5. **Generate an arbitrary waveform.**
6. **Generate a modulated waveform.**
7. **Generate a frequency Sweep.**
8. **Generate a Burst waveform.**
9. **IQ (In-Phase/Quadrature) modulation.**
10. **Frequency hopping output.**
11. **Storage management.**
12. **Synchronize multiple Generators.**
13. **Seamlessly connected with the RIGOL DS.**
14. **Get technical support from RIGOL.**

Chapter 2 Basic Waveform Output

This chapter introduces how to output basic waveforms such as Sine, Square, etc. The generator can output basic waveforms from the single channel or two channels at the same time.

Subjects in this chapter:

- To Output Sine Waveform
- To Output Square Waveform
- To Output Ramp Waveform
- To Output Pulse Waveform
- To Output Noise Waveform
- Align Phase

To Output Sine Waveform

To output a sine waveform from CH1 with 20 kHz frequency, 2.5 Vpp amplitude, 500 mVdc offset and 10 ° start phase.

1. Select Channel

Press **CH1 | CH2** to select CH1. "CH1" in Channel Label Bar will be highlighted indicating that CH1 has been selected.

2. Select Sine Waveform

Press **Sine** to select Sine waveform. The key will be illuminated and the corresponding menu display at the bottom of the screen.

3. Set the Frequency/Period

Press **Freq/Period** to highlight "Freq", and then use the numeric keyboard to input "20" and select the unit "kHz" in the pop-up menu.

- Sine waveform frequency range: 1 μ Hz to 350 MHz.
- Press the softkey again to switch to "Period".
- Selectable frequency units: MHz, kHz, Hz, mHz, μ Hz.
- Selectable period units: sec, msec, μ sec, nsec.
- You can also use the knob to modify this parameter.

4. Set the Amplitude

Press **Ampl/HiLevel** to highlight "Ampl", and then use the numeric keyboard to input "2.5" and select the unit "Vpp" in the pop-up menu.

- The amplitude range is limited by the "**Resistance**" and "**Freq/Period**" settings. Please refer to the "Output Characteristic" described in "**Specifications**".
- Amplitude and offset, HiLevel and LoLevel, always exist in pairs. Press the softkey again to switch to "HiLevel".
- Selectable amplitude units: Vpp, mVpp, Vrms, mVrms, dBm (non-high impedance).
- Selectable high level units: V, mV.
- You can also use the knob to modify this parameter.

5. Set the DC Voltage Offset

Press **Offset/LoLevel** to highlight "Offset", and then use the numeric keyboard

to input "500" and select the unit "mV_{DC}" in the pop-up menu.

- The offset range is limited by the "**Resistance**" and "**Ampl/HiLevel**" setting. Please refer to the "Output Characteristic" described in "**Specifications**".
- Amplitude and offset, HiLevel and LoLevel, always exist in pairs. Press the softkey again to switch to "LoLevel". Note that the low level should be at least 5 mV (50Ω) lower than the high level.
- Selectable offset units: V_{DC}, mV_{DC}.
- Selectable low level units: V, mV.
- You can also use the knob to modify this parameter.

6. Set the Start Phase

Press **Start Phase** to highlight the softkey, and then use the numeric keyboard to input "10" and select the unit "°" in the pop-up menu.

- Start Phase range: 0 ° to 360 °.
- You can also use the knob to modify this parameter.

7. Channel Setting

Besides the above steps, you can also configure the output parameters related to the channel through "**Channel Setting**" menu in **Utility**. As shown in the following figure, the main output parameters (**Resistance** and **Attenuation**) of the channel are shown at the bottom of the screen.



8. Enable the Output

Press **Output** of CH1 to highlight the key, which indicates the waveform output from the [Output] connector of CH1 has been enabled. If an overload message appears on the screen, please cut off the connection between the [Output] connector and the external devices, and then press **Output** again to re-enable the output.

Units Switching

You can quickly switch the output unit of the current parameters from the front panel. For example, to transform 2 Vpp to a value whose unit is Vrms, press the key in the numeric keyboard and then select the unit "Vrms" in the pop-up menu. If for a Sine waveform, the transformed value is 707.2 mVrms. You will find DG5000 is also an excellent "calculator".

To Output Square Waveform

To output a square waveform from CH1 with 20 kHz frequency, 2.5 Vpp amplitude, 500 mVdc offset, 30% duty cycle and 10 ° start phase. Refer to **“To Output Sine Waveform”** to configure the parameters and output. This section will only talk about **“Duty Cycle”**.

What’s Duty Cycle?

Duty Cycle is defined as the percentage that the high level takes up in the whole period.

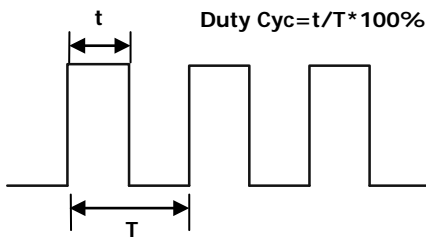

Set the Duty Cycle

1. Press **Square** to select square waveform. The key will be illuminated and the corresponding menu display at the bottom of the screen.
2. Press **Duty Cycle** to highlight the softkey, and then use the numeric keyboard to input “30” and select the unit “%” in the pop-up menu.
 - The duty cycle range is limited by the **“Freq/Period”** setting.
For frequency lower than or equal to 10 MHz: 20% to 80%
For frequency greater than 10 MHz and lower than or equal to 40 MHz: 40% to 60%
For frequency greater than 40 MHz: 50%
 - You can also use the knob to modify this parameter.

To Output Ramp Waveform

To output a ramp waveform from CH1 with 20 kHz frequency, 2.5 V_{pp} amplitude, 500 mV_{dc} offset, 80% symmetry and 10 ° start phase. Refer to “**To Output Sine Waveform**” to configure the parameters and output. This section will only talk about “Symmetry”.

What’s symmetry?

Symmetry is defined as the percentage that the rising period takes up in the whole period.

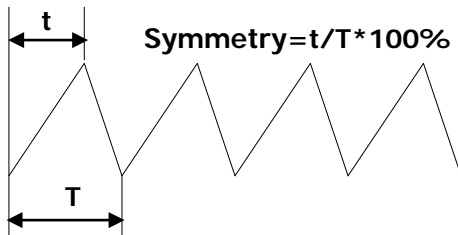

Set the Symmetry

1. Press **Ramp** to select ramp waveform. The key will be illuminated and the corresponding menus display at the bottom of the screen.
3. Press **Symmetry** to highlight the softkey, and then use the numeric keyboard to input “80” and select the unit “%” in the pop-up menu.
 - Symmetry range: 0% to 100%.
 - You can also use the knob to modify this parameter.

To Output Pulse Waveform

To output a pulse waveform from CH1 with 20 kHz frequency, 2.5 V_{pp} amplitude, 500 mV_{dc} offset, 10 μs pulse width (20% duty cycle), 50 ns leading and trailing edge time and 8 μs delay. Refer to “**To Output Sine Waveform**” to configure the parameters and output. This section will only talk about “Width/Duty”, “Leading”, “Trailing”, “Delay” and “Restore”.

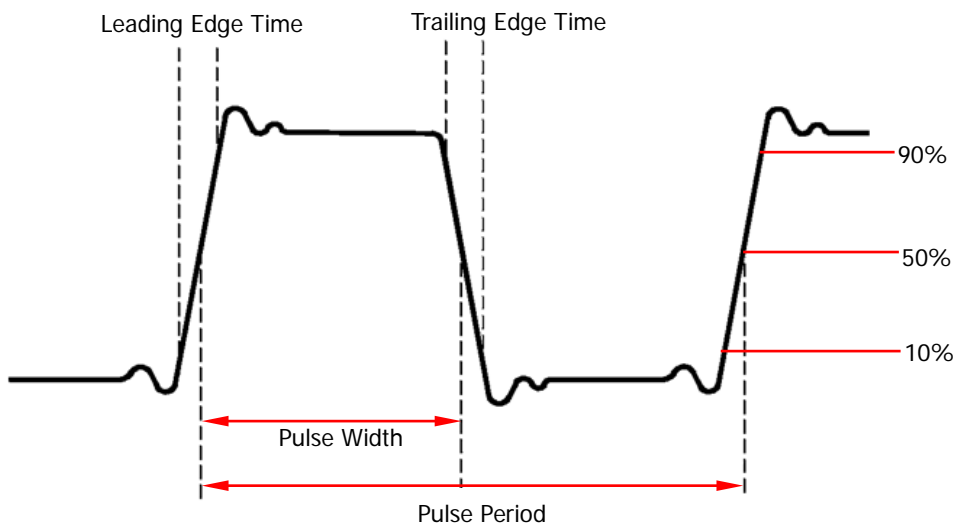

Pulse Width/Duty Cycle

Pulse Width is defined as the time from the 50% threshold of a leading edge amplitude to the 50% threshold of the next trailing edge amplitude as shown in the figure above. Duty Cycle is defined as the percentage that the pulse width takes up in the pulse period.

Press **Pulse** → **Width/Duty** to highlight “Pulse Width”, and then use the numeric keyboard to input “10” and select the unit “μsec” in the pop-up menu.

- Pulse Width is limited by the “**Minimum Pulse Width**” and the “**Pulse Period**”.
 Minimum Pulse Width = 4 ns
 Pulse Width ≥ Minimum Pulse Width
 Pulse Width ≤ Pulse Period - Minimum Pulse Width × 2
- Pulse Width and Duty Cycle are correlative. Once a parameter is changed, the

other one will be automatically changed. Press the softkey again to switch to “Duty Cycle” (having been automatically set to 20% in this example, refer to “**Set the Duty Cycle**” for manual setting). Pulse Duty Cycle is limited by the “**Minimum Pulse Width**” and the “**Pulse Period**”.

Pulse Duty Cycle $\geq 100 \times \text{Minimum Pulse Width} \div \text{Pulse Period}$

Pulse Duty Cycle $\leq 100 \times (1 - 2 \times \text{Minimum Pulse Width} \div \text{Pulse Period})$

- Selectable Pulse Width units: sec, msec, μsec , nsec.
- You can also use the knob to modify this parameter.

Leading/Trailing Edge

The Leading (rising) edge time is defined as the duration of the pulse amplitude rising from 10% to 90% threshold, while the Trailing (falling) edge time is defined as the duration of the pulse amplitude moving down from 90% to 10% threshold.

Press **Pulse** → **Leading** (or **Trailing**) to highlight the softkey, and then use the numeric keyboard to input “50” and select the unit “nsec” in the pop-up menu.

- Edge Time range: 2.5 ns to 1 ms.
- Selectable Leading/Trailing Edge Time units: sec, msec, μsec , nsec.
- You can also use the knob to modify this parameter.

Delay

Delay is defined as the delayed time of the output of a channel relative to the output of the other channel. Note that the delay function is only for dual-channel models.

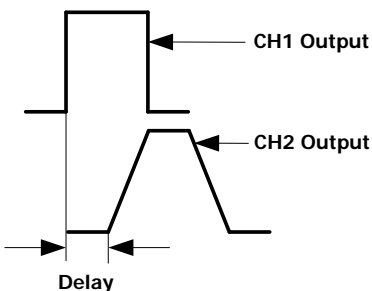

Press **Pulse** → **Delay** to highlight the softkey, and then use the numeric keyboard to

input "8" and select the unit "μsec" in the pop-up menu.

- Delay Time range: 0 s to pulse period
- Selectable Delay Time units: sec, msec, μsec, nsec.
- You can also use the knob to modify this parameter.

Restore Delay

Press **Pulse**, then use  to open the 2/2 menu page and press **Restore**, the generator will align the delay between the two channels. Note that the restore delay function is only for dual-channel models.

Assume that CH1 and CH2 output pulse waveforms with the same parameters. Use the oscilloscope to sample the waveforms of the two channels and display them stably. The two waveforms displayed on the oscilloscope have a certain delay. At this point, press **Restore** on the generator and the waveforms will be displayed on the oscilloscope without any delay.

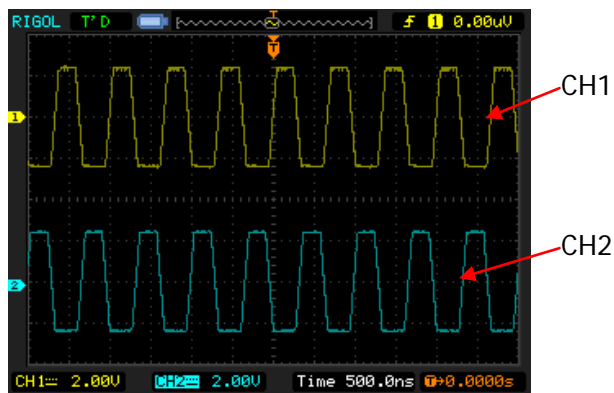

Before Restore

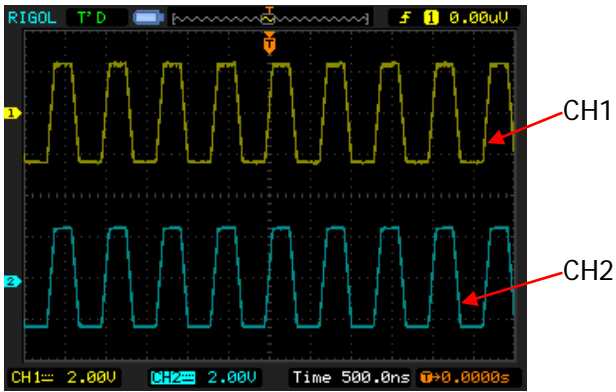

After Restore

Note: For dual-channel models, the corresponding **Delay** and **Restore** are grayed out and disabled if any of the two channels is in modulation mode.

To Output Noise Waveform

To output noise waveform from CH1 with 2.5 Vpp amplitude and 500 mV_{DC} offset. Refer to **"To Output Sine Waveform"** to configure the parameters and output.

Align Phase

Pressing **Align Phase** will re-configure the two channels and enable the generator to output with the specified frequency and start phase. Note that the align phase function is only for dual-channel models.

For two signals whose frequencies are the same or in multiple, this operation will align their phase. For example, assume a sine waveform (1 kHz, 5 Vpp, 0 °) is outputted from CH1, while another (1 kHz, 5 Vpp, 180°) from CH2. Use an oscilloscope to sample and display the two signals stably. You will see that the waveforms shown on the oscilloscope do not always have a phase deviation of 180°. Now, press **Align Phase** on the generator. The waveforms shown on the oscilloscope will have a phase deviation of 180° without any adjustment of the start phase of the signal generator.

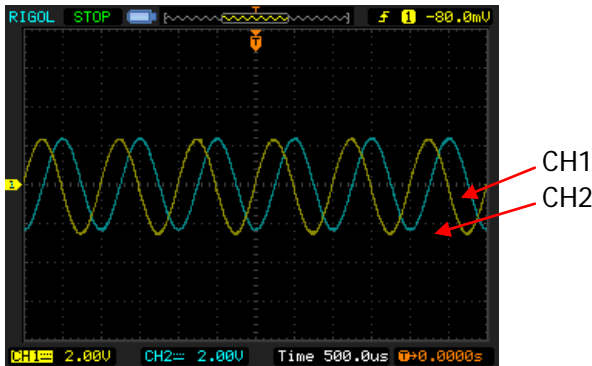

Before Align Phase

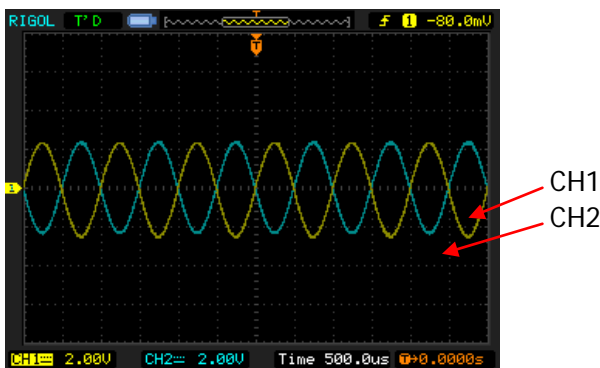

After Align Phase

Note: For dual-channel models, the **Align Phase** menu is grayed and disabled when any one of the two channels is in modulation mode.

Chapter 3 Arbitrary Waveform Output

This chapter introduces how to output built-in or user-defined arbitrary waveforms. The generator enable to output arbitrary waveforms from the single channel or two channels at the same time.

Subjects in this chapter:

- To Enable Arbitrary Waveform
- Output Mode
- To Select Arbitrary Waveform
- To Create New Arbitrary Waveform
- To Edit Arbitrary Waveform

To Enable Arbitrary Waveform

Press **Arb** to open the operation menu of arbitrary waveform.

1. Freq/Period (Sample)

Set the output "Frequency/Period" of the arbitrary waveform in "Normal" mode.
Set the sample rate when the generator sample data from external memory in "Play" mode.

2. Ampl/HiLevel

Set the output "Amplitude/High Level" of the arbitrary waveform.

3. Offset/LoLevel

Set the output "Offset/Low Level" of the arbitrary waveform.

4. Phase

Set the "Initial Phase" of the arbitrary waveform.

5. Align Phase

Refer to "Align Phase".

6. Mode

Select the output mode of the arbitrary waveform to "Normal" or "Play".

7. Select Wform

Select arbitrary waveform stored in internal or external memories.

8. Create New

Users can define waveform with up to 512k points.

Note: DG5000 can output waveform with up to 128M points. For the waveform of which the number of points is more than 512kpts, users can use the matching PC software of DG5000 to edit and download waveform to DG5000 for output.

9. Edit Wform

Edit the stored arbitrary waveform.

Refer to **“To Output Sine Waveform”** to configure the parameters and output. This chapter will focus on **“Mode”**, **“Sample”**, **“Select Waveform”**, **“Create New”** and **“Edit Waveform”**.

Output Mode

Press **Arb** → **Mode** to set arbitrary waveform output mode to “Normal” or “Play”.

The generator adopts DDS to generate waveform data in “Normal” mode. In this case, you can change the phase step of the sampling by changing the Frequency (Period). However, the sample rate is fixed. To change the sample rate, you should use the “Play” mode.

Normal Mode

In this mode, the generator can output internal waveforms which are defined on line by users or downloaded from PC after edited on PC software. Waveforms stored in a USB storage device can also be read and outputted. The output frequency ranges from 1 μHz to 50 MHz, and the sample rate is fixed at 1G Sa/s, while the number of points is 16Mpts.

As shown in the figure below, press **Mode** and select “Normal”, and then press **Freq/Period** to change the frequency.

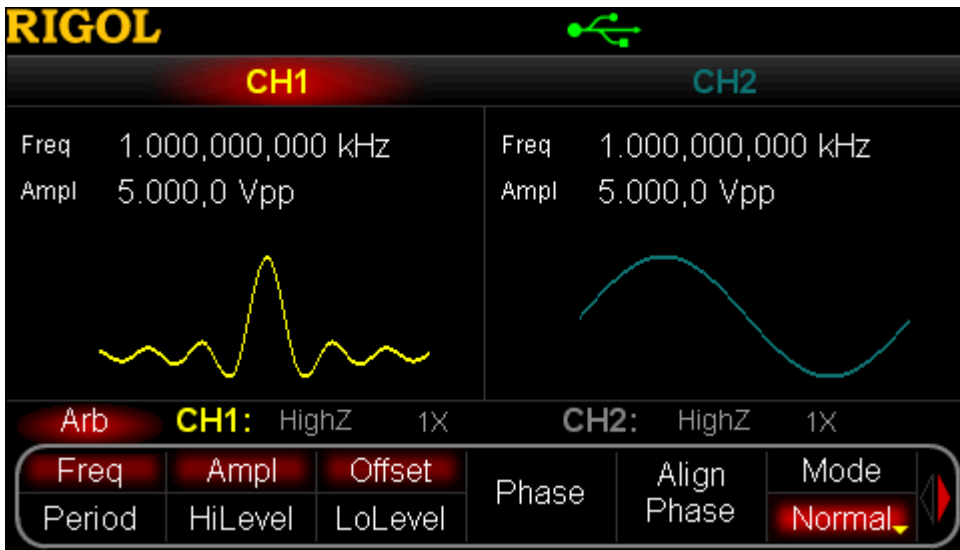

Figure 3-1 Arbitrary waveform output mode (Normal)

Play Mode

The generator will enable the “Play” mode once the number of points of the arbitrary waveform to be output is greater than 16 Mpts and be able to output waveform with up to 128 Mpts. In this mode, you can adjust the sample rate **fs** through setting the frequency division coefficient **N**. The function relationship between **fs** and **N** is as following:

$$\text{When } N \leq 2, f_s = \frac{1G \text{ Sa/s}}{2^N}$$

$$\text{When } N > 2, f_s = \frac{1G \text{ Sa/s}}{(N-2) \times 8}$$

The range of N is from 0 to 268435456 (2^{28}).

As shown in the figure below, press **Mode** to select “Play”. As can be seen, **Freq/Period** will change to **Sample** which denotes the frequency division coefficient **N**. Use the numeric keyboard or knob to modify the parameter.

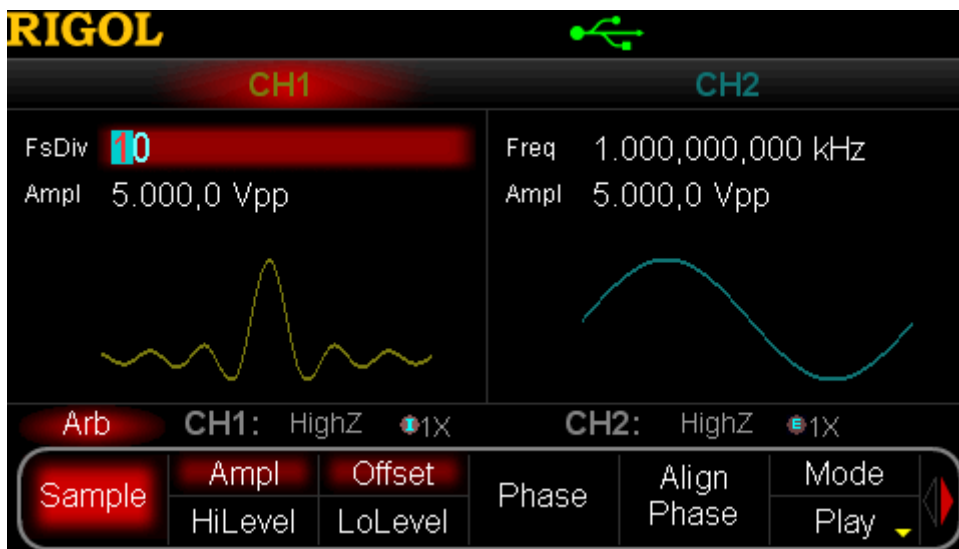



Figure 3-2 Arbitrary waveform output mode (Play)

To Select Arbitrary Waveform

Press **Arb**, use  to open the 2/2 menu page, and then press **Select Wform** to select "Built-in", "Stored Wforms" or "Volatile Wform" for arbitrary waveform output.

Built-In Waveform

10 kinds of built-in arbitrary waveforms are provided by DG5000, including DC (amplitude ranging from -10 V to 10 V), Sinc, Exponential Rise, Exponential Fall, ECG, Gauss, Haversine, Lorentz, Pulse and Dual Tones.

Pulse

The Pulse mentioned here can be configured by setting the parameters "Width/Duty", "Leading" and "Trailing".

- **Width/Duty:** the minimum Pulse Width is related to the current edge time, ranging from 4 ns to "Pulse Period - 12 ns", while Duty Cycle ranges from 0% to 100%.
- **Leading:** ranges from 2.5 ns to 1.9531 ks, and relates to the pulse period, pulse width and the trailing edge.
- **Trailing:** ranges from 2.5 ns to 1.9531 ks, and relates to the pulse period, pulse width and the leading edge.

Dual Tones

The Dual Tones signal can be used to measure the inter-modulation distortion characteristic of non-linear devices (such as mixer or amplifier). Inter-Modulation Distortion (IMD) will be generated when a non-linear device with multiple input frequencies disturbs the adjacent channels or causes unexpected output at other frequencies. DG5000 enables to generate such Dual Tones that the Inter-Modulation Distortion from it can be measured by a Spectrum Analyzer. When measuring the Inter-Modulation Distortion generated by the device under test (DUT), this signal can be used as the measurement source.

Stored Waveform

Select arbitrary waveforms stored in internal non-volatile memory (C Disk) or external memories (D Disk or E Disk).

Press this softkey to enter the Store/Recall Interface and the backlight of the **Store/Recall** key on the front panel is illuminated. Please select and read the desired arbitrary waveform file. For more details, please refer to “**Store and Recall**”. Waveform data in volatile memory will be changed after the file is read. To return arbitrary waveform setting interface, press the **Arb**.

Volatile Waveform

Select arbitrary waveform currently stored in the volatile memory. Note that this menu would be unavailable if there is no waveform data in volatile memory currently. To fill up the volatile memory, you can create a waveform through “**Create New**” or select a waveform from “**Built-In**” or “**Stored Wforms**”.

To Create New Arbitrary Waveform

Press **Arb**, use  to open the 2/2 menu page, and then press **Create New** to open the arbitrary waveform create interface.

1. Cycle Period

Press this softkey and use the numeric keyboard or knob to set the cycle period of the new waveform. The setting range is from 20 ns to 1 Ms. Note that the time of the last point that can be defined should be less than the cycle period.

2. High VLimit

Press this softkey and use the numeric keyboard or knob to set the higher level of the new waveform. The upper limit of this level is +5 V (50 Ω), and the lower limit is the minimum which is greater than current setting of the "**Low VLimit**".

3. Low VLimit

Press this softkey and use the numeric keyboard or knob to set the lower level of the new waveform. The lower limit of this level is -5 V (50 Ω), and the upper limit is the maximum which is lower than current setting of the "**High VLimit**".

4. Init #Points

When creating a new waveform, the waveform editor will automatically create a waveform with two points. By default, point 1 is located at 0 s and the time value of point 2 is slightly less than the specified cycle period. In addition, the voltages of the two points are equal to the specified "**Low VLimit**".

Press this softkey and use the numeric keyboard or the knob to set the initial points of the new waveform. The initial points of the arbitrary waveform can be up to 524488 (512 kpts) points. If needed, you can insert or delete points (refer to "**Insert Point**" or "**Delete Point**" below).

5. Interp

Press this softkey to enable or disable the interpolation between the defined waveform points.

- **Off:** disable the interpolation. The waveform editor will hold a constant voltage level between two points and create a step waveform.
- **Linear:** the waveform editor will automatically connect two defined points with a straight line.

- **Sinc:** the waveform editor will automatically connect the two points with a smooth curve. Notice that, the interpolation point voltage may be without the arbitrary waveform level limit and an unexpected curve will be acquired if the defined point voltage is the same as **High VLimit** or **Low VLimit**. Thus, try not to define the point voltage as the **High VLimit** or **Low VLimit** values.

6. Edit Points

Define a waveform by specifying the time and voltage of each waveform point. Press this softkey to enter the "Edit Points" interface.

- **PointID:** set the ID of the point to be edited. The default is 1. You can use the numeric keyboard or knob to modify this parameter.
- **Time:** set the time of the current point. This setting is limited by the time of the previous and the next points. Note that the time of point 1 is fixed at 0 s.
- **Voltage:** set the voltage of the current point in mV or V. The range of the voltage value is limited by the "**High VLimit**" and "**Low VLimit**" specified in the initialization.
- **Insert Point:** insert a waveform point at the middle position of the currently edited point and the next edited point.
- **Delete Point:** delete the current point from the waveform and connect the remaining points using the current interpolation method. Note that point 1 and the last point cannot be deleted.

7. Edit Block

Define a waveform by editing the time and voltage of the start and end points and automatically setting the points between them through linear interpolation. Press **Interp** to select "Linear", and then press this softkey to enter the "Edit Block" interface.

- **X1:** set the ID (namely the time of the start point of the block) of the start point of the block. Note that this value should be less than the "Init Points" and be less than or equal to X2.
- **Y1:** set the voltage of the start point in mV or V.
- **X2:** set the ID (namely the time of the end point of the block) of the end point of the block. Note that this value should be less than or equal to the "Init Points" and be greater than or equal to X1.
- **Y2:** set the voltage of the end point in mV or V.
- **Execute:** edit the points within the start and end points according to the current setting.
- **Delete:** delete the points that can be edited between X1 and X2 and connect

the start and end points using the current interpolation method. Note that point 1 and the last point cannot be deleted.

8. Save

The currently created waveform is stored in the volatile memory. When creating a new waveform, the previous waveform in volatile memory will be overwritten. Press this softkey to enter the file storage interface (refer to “**Store and Recall**”). Users can store the edited waveform into internal memory (C Disk) or external memories (D Disk or E Disk) of the instrument.

Tips

Users can store the waveform edited by PC software into the local memory of the instrument through the following two methods:

- ✧ Use SCPI commands (for more information, see the *Programming Guide* of this generator).

For waveform with greater than 16 kpts:

```
:TRACe:DAC VOLATILE16,<flag>,<len>,<binary_block_data>
```

For waveform with less than 16 kpts:

```
:TRACe:DAC VOLATILE,<binary_block_data>
```

- ✧ Use the file management system to transfer files from USB storage device (recognized as D Disk or E Disk in the generator) to internal memory (C Disk) of the instrument.

Edit Points

The following example introduces how to create an arbitrary waveform which meets with the following conditions by using “Edit Points”.

Parameter	Value
Cycle Period	12 μ s
High VLimit	4 V
Low VLimit	-2 V
Interpolation	Linear
Point 1	0 s, 0 V
Point 2	4 μ s, 4 V
Point 3	8 μ s, 0 V
Point 4	10 μ s, -2 V

Operating Procedures:

1. Press **Arb**, use  to open the 2/2 menu page, and then press **Create New** → **Cycle Period**, use the numeric keyboard to input “12” and select the unit “ μ sec” in the pop-up menu.
2. Press **High VLimit**, use the numeric keyboard to input “4” and select the unit “V” in the pop-up menu.
3. Press **Low VLimit**, use the numeric keyboard to input “-2” and select the unit “V” in the pop-up menu.
4. Press **Init #Points**, use the numeric keyboard to input “4” and then press **OK**. Note that a level line of -2 V appears.
5. Press **Interp** to select “Linear”.
6. Press **Edit Points** to enter the “Edit Point” interface.
 - 1) Press **PointID** to define the first point (default time is 0). Press **Voltage** and

use the numeric keyboard to input "0" and select the unit "V" in the pop-up menu.

- 2) Press **PointID** again and use the numeric keyboard or knob to select point 2. Then press **Time** and **Voltage** respectively to define point 2 as 4 μs and 4 V.
- 3) Define point 3 and point 4 according step 2).
- 4) After all the points are edited, press **OK** to return to the upper level menu, then press **Save** to enter the file storage interface (refer to "**Store and Recall**") and save the edited waveform.

7. View the edited waveform.

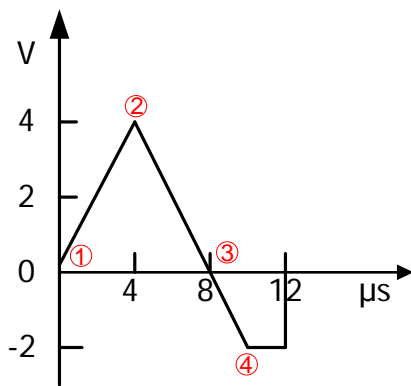

Note: As can be seen from the above figure, the waveform editor will always connect the voltage levels from the first point to the last point, and then maintain the level of the last point until the cycle period expires to create a continuous waveform.

Edit Block

The following example introduces how to create an arbitrary waveform which meets the following conditions with the following conditions met by using "Edit Block".

Parameter	Value
Cycle Period	12 μ s
High VLimit	4 V
Low VLimit	-2 V
Interpolation	Linear
Start	2, 4 V
End	4, -2 V

Operating Procedures:

1. Press **Arb**, use  to open the 2/2 menu page, and then press **Create New** → **Cycle Period**, use the numeric keyboard to input "12" and select the unit " μ sec" in the pop-up menu.
2. Press **High VLimit**, use the numeric keyboard to input "4" and select the unit "V" in the pop-up menu.
3. Press **Low VLimit**, use the numeric keyboard to input "-2" and select the unit "V" in the pop-up menu.
4. Press **Init #Points**, use the numeric keyboard to input "4" and then press **OK**. Note that a level line of -2 V appears.
5. Press **Interp** to select "Linear".
6. Press **Edit Block** to enter the "Edit Block" interface.
 - 1) Press **X1** and use the numeric keyboard to input "2". Then press **Y1** and use the numeric keyboard to input "4" and select the unit "V" in the pop-up menu. Use the same method to set X2 and Y2.
 - 2) Press **Excute** to apply the setting defined in step 1). The waveform editor will

automatically use straight lines to connect the start point (point 2, the level is 4 V) with the stop point (point 4, the level is -2 V) and automatically generate point 1 and point 3 to create a continuous waveform.

- 3) After all the points are edited, press **Return** to return to the upper level menu, then press **Save** to enter the file storage interface (refer to “**Store and Recall**”) and save the edited waveform.

7. View the edited waveform.

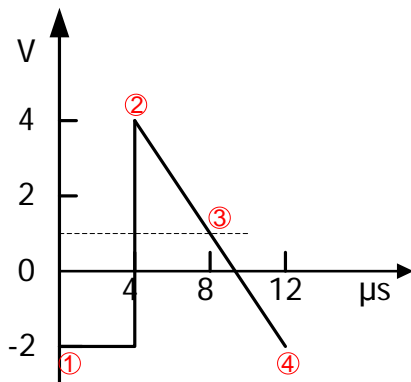

Note: As can be seen from the above figure, the waveform editor inserts values between the start point (point 2) and stop point (point 4) in the current interpolation method and then automatically generates point 1 and point 3 to create a continuous waveform.

To Edit Arbitrary Waveform

Arbitrary waveforms stored both in volatile memory and non-volatile memories can be recalled and re-edited.

Press **Arb** and use  to open the 2/2 menu page, then press **Edit Wform** to open waveform editing menu. Note that, only "Select Wform" is new in this menu compared to **Create New**, which will be introduced in this section. For other menu functions and operations, please refer to "To Edit Arbitrary Waveform".

Press **Edit Wform** → **Select Wform** to select the waveform to be edited.

1. To Edit Built-In waveforms

Select a waveform from the built-in waveforms to edit. You can store the edited waveform without overwriting the selected built-in waveform.

2. To Edit Stored Waveforms

Select a waveform from internal non-volatile memory (C Disk) or external memories (D Disk or E disk) to edit. You can overwrite the old waveform or save it as a new file.

3. To Edit Waveform in Volatile Memory

Select waveform stored in current volatile memory to edit. The previous data in the volatile memory would be overwritten by the new waveform data. You can also save it into the non-volatile memory.

Chapter 4 Common Modulation Output

DG5000 can output versatile modulated waveforms with modulation types of analog modulation (AM, FM, PM), digital modulation (ASK, FSK, PSK) and pulse width modulation (PWM). The generator provides a variety of internal modulating waveform sources and also accepts external modulating signal from Mod in/I or ExtTrig connector at the rear panel. The modulated waveforms can be output from the single channel or the two channels at the same time.

Subjects in this chapter:

- Amplitude Modulation (AM)
- Frequency Modulation (FM)
- Phase Modulation (PM)
- Amplitude Shift Keying (ASK)
- Frequency Shift Keying (FSK)
- Phase Shift Keying (PSK)
- Pulse Width Modulation (PWM)

Amplitude Modulation (AM)

An AM (Amplitude Modulation) modulated waveform consists of carrier waveform and modulating waveform. The amplitude of the carrier waveform varies with the instantaneous voltage of the modulating waveform.

To Select AM Modulation

Press **Mod** → **Type** → **AM** to enable AM function.

- When **Mod** is enabled, **Sweep** or **Burst** will be disabled automatically (if enabled currently).
- After AM is enabled, the instrument will generate AM waveform with the current specified carrier and modulating waveform.

To Select Carrier Waveform Shape

AM carrier waveform shape could be Sine, Square, Ramp or Arbitrary waveform. The default is Sine.

- Press the front panel key **Sine**, **Square**, **Ramp** or (**Arb** → **Select Wform**) to select a desired carrier waveform shape.
- Pulse (basic waveform), Noise and DC could not be used as carrier waveform.

To Set Carrier Frequency

After the carrier waveform shape is selected, you can press **Freq/Period** to highlight "Freq", and then use the numeric keyboard or knob to input desired frequency value. The available carrier frequency varies with different carrier waveforms.

- Sine: 1 μ Hz to 350 MHz
- Square: 1 μ Hz to 120 MHz
- Ramp: 1 μ Hz to 5 MHz
- Arbitrary waveform: 1 μ Hz to 50 MHz

To Select Modulating Waveform Source

Press **Mod** → **Source** to select “Int” or “Ext” modulating waveform source.

1. Internal Source

When internal modulation source is selected, press **Shape** to select Sine, Square, Triangle, UpRamp, DnRamp, Noise or Arb as modulating waveform. The default is Sine.

- Square: Duty Cycle is 50%.
- Triangle: Symmetry is 50%.
- UpRamp: Symmetry is 100%.
- DnRamp: Symmetry is 0%.
- Arb: when the current arbitrary waveform is selected as the modulating waveform, the generator automatically limits the arbitrary waveform length as 2 kpts through sampling.

Note: Noise could be used as modulating waveform but not carrier waveform.

2. External Source

When external modulation source is selected, the **Shape** menu will be grayed out and disabled. The generator accepts the external modulating signal from the Mod in/I connector at the rear panel. The AM modulation amplitude is controlled by the ± 6 V signal level of the connector.

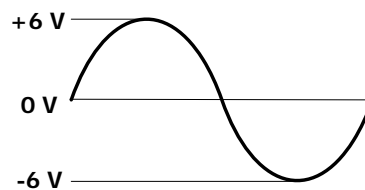
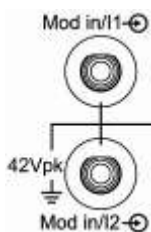

To Set Modulating Waveform Frequency

When internal modulation source is selected, press **AM_Freq** to set the modulating waveform frequency.

- Input the desired frequency value using the numeric keyboard or knob.
- The modulating waveform frequency ranges from 2 mHz to 50 kHz, and the default value is 100 Hz.

Note: This menu will be grayed out and disabled when external modulation source is selected.

To Set Modulation Depth

Modulation depth expressed as a percentage indicates the amplitude vibration degree. The AM modulation depth ranges from 0% to 120%. Press **AM Depth** to set AM modulation depth.

- When the modulation depth is 0%, the output amplitude is the half of the specified value.
- When the modulation depth is 100%, the output amplitude is equal to the specified value.
- When the modulation depth is higher than 100%, the output of the instrument will not exceed 10 V_{pp} (The load is 50 Ω).

When external source is selected, AM modulation amplitude is also controlled by the ±6 V signal level of the Mod in/I connector at the rear panel. For example, if the modulation depth is 100%, the output amplitude is the maximum when the modulating signal level is +6 V and the minimum when the level is -6 V.

Frequency Modulation (FM)

A FM (Frequency Modulation) modulated waveform consists of carrier waveform and modulating waveform. The frequency of the carrier waveform varies with the instantaneous voltage of the modulating waveform.

To Select FM Modulation

Press **Mod** → **Type** → **FM** to enable FM function.

- When **Mod** is enabled, **Sweep** or **Burst** will be disabled automatically (if currently enabled).
- After FM is enabled, the instrument will generate FM waveform with the currently specified carrier and modulating waveform.

To Select Carrier Waveform Shape

FM carrier waveform shape could be Sine, Square, Ramp or Arbitrary waveform. The default is Sine.

- Press the front panel key **Sine**, **Square**, **Ramp** or **(Arb) → Select Wform** to select a desired carrier waveform shape.
- Pulse (basic waveform), Noise and DC could not be used as carrier waveform.

To Set Carrier Frequency

After the carrier waveform shape is selected, press **Freq/Period** to highlight "Freq", and then use the numeric keyboard or knob to input desired frequency value. The available carrier frequency varies with different carrier waveforms.

- Sine: 1 μ Hz to 350 MHz
- Square: 1 μ Hz to 120 MHz
- Ramp: 1 μ Hz to 5 MHz
- Arbitrary waveform: 1 μ Hz to 50 MHz

To Select Modulating Waveform Source

Press **Mod** → **Source** to select “Int” or “Ext” modulating waveform source.

1. Internal Source

When internal modulation source is selected, press **Shape** to select Sine, Square, Triangle, UpRamp, DnRamp, Noise or Arb as modulating waveform. The default is Sine.

- Square: Duty Cycle is 50%.
- Triangle: Symmetry is 50%.
- UpRamp: Symmetry is 100%.
- DnRamp: Symmetry is 0%.
- Arb: when the current arbitrary waveform is selected as the modulating waveform, the generator automatically limits the arbitrary waveform length as 2 kpts through sampling.

Note: Noise could be used as modulating waveform but not carrier waveform.

2. External Source

When external modulation source is selected, the **Shape** menu will be grayed out and disabled. The generator accepts the external modulating signal from the Mod in/I connector at the rear panel. The frequency deviation is controlled by the ± 6 V signal level of the connector.

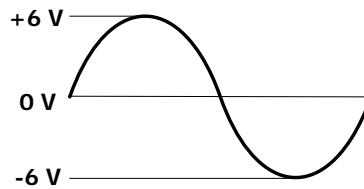
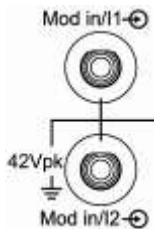

To Set Modulating Waveform Frequency

When internal modulation source is selected, press **FM_Freq** to set the modulating waveform frequency.

- Input the desired frequency value using the numeric keyboard or knob.
- The modulating waveform frequency ranges from 2 mHz to 50 kHz, and the default value is 100 Hz.

Note: This menu will be grayed out and disabled when external modulation source is selected.

To Set Frequency Deviation

Press **Deviation** to set the frequency deviation of the modulating waveform frequency relative to the carrier waveform frequency.

- The frequency deviation must be less than or equal to the carrier waveform frequency.
- The sum of frequency deviation and carrier frequency must be less than or equal to the sum of upper limit of current carrier frequency and 1 kHz.

When external source is selected, frequency deviation is controlled by the ± 6 V signal level of the Mod in/I connector at the rear panel. For example, if the frequency deviation is set as 1 kHz, +6 V signal level corresponds to a 1 KHz increase in frequency. Lower external signal level generates less deviation, and negative signal level will reduce the frequency below the carrier waveform frequency.

Phase Modulation (PM)

A PM (Phase Modulation) modulated waveform consists of carrier waveform and modulating waveform. The phase of the carrier waveform varies with the instantaneous voltage of the modulating waveform.

To Select PM Modulation

Press **Mod** → **Type** → **PM** to enable PM function.

- When **Mod** is enabled, **Sweep** or **Burst** will be automatically disabled (if currently enabled).
- After PM is enabled, the instrument will generate PM waveform with the currently specified carrier and modulating waveform.

To Select Carrier Waveform Shape

PM carrier waveform shape could be Sine, Square, Ramp or Arbitrary waveform. The default is Sine.

- Press the front panel key **Sine**, **Square**, **Ramp** or **(Arb) → Select Wform** to select desired carrier waveform shape.
- Pulse (basic waveform), Noise and DC could not be used as carrier waveform.

To Set Carrier Frequency

After the carrier waveform shape is selected, press **Freq/Period** to highlight "Freq", and then use the numeric keyboard or knob to input desired frequency value. The available carrier frequency varies with different carrier waveforms.

- Sine: 1 μ Hz to 350 MHz
- Square: 1 μ Hz to 120 MHz
- Ramp: 1 μ Hz to 5 MHz
- Arbitrary waveform: 1 μ Hz to 50 MHz

To Select Modulating Waveform Source

Press **Mod** → **Source** to select “Int” or “Ext” modulating waveform source.

1. Internal Source

When internal modulation source is selected, press **Shape** to select Sine, Square, Triangle, UpRamp, DnRamp, Noise or Arb as modulating waveform. The default is Sine.

- Square: Duty Cycle is 50%.
- Triangle: Symmetry is 50%.
- UpRamp: Symmetry is 100%.
- DnRamp: Symmetry is 0%.
- Arb: when the current arbitrary waveform is selected as the modulating waveform, the generator automatically limits the arbitrary waveform length as 2 kpts through sampling.

Note: Noise could be used as modulating waveform but not carrier waveform.

2. External Source

When external modulation source is selected, the **Shape** menu will be grayed out and disabled. The generator accepts the external modulating signal from the Mod in/I connector at the rear panel. The phase deviation is controlled by the ± 6 V signal level of the connector.

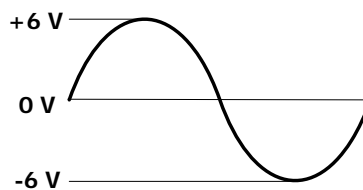
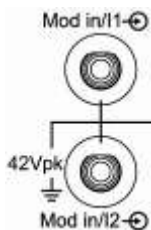

To Set Modulating Waveform Frequency

When internal modulation source is selected, press **PM_Freq** to set the modulating waveform frequency.

- Input the desired frequency value using the numeric keyboard or knob.
- The modulating waveform frequency ranges from 2 mHz to 50 kHz, and the default value is 100 Hz.

Note: This menu will be grayed out and disabled when external modulation source is selected.

To Set Phase Deviation

Press **Deviation** to set the deviation of the modulating waveform phase relative to the carrier waveform phase.

- Input the desired phase using the numeric keyboard or knob.
- The phase deviation ranges from 0° to 360°.

When external source is selected, phase deviation is controlled by the ± 6 V signal level of the Mod in/I connector at the rear panel. For example, if the phase deviation is set as 180°, +6 V signal level corresponds to a 180° phase change. Lower external signal level generates less deviation.

Amplitude Shift Keying (ASK)

When using ASK (Amplitude Shift Keying) modulation, you can configure the generator to make its output amplitude “shift” between two preset amplitude values (“carrier amplitude” and “modulating amplitude”). The “shift” rate (ASK Rate) is determined by the signal level inside the instrument or from the ExtTrig connector at the rear panel.

To Select ASK Modulation

Press **Mod** → **Type** → **ASK** to enable ASK function.

- When **Mod** is enabled, **Sweep** or **Burst** will be disabled automatically (if enabled currently).
- After ASK is enabled, the instrument will generate ASK waveform with the currently specified carrier and modulating waveform.

To Select Carrier Waveform Shape

ASK carrier waveform shape could be Sine, Square, Ramp or arbitrary waveform. The default is Sine.

- Press the front panel key **Sine**, **Square**, **Ramp** or **(Arb) → Select Wform** to select desired carrier waveform shape.
- Pulse (basic waveform), Noise and DC could not be used as carrier waveform.

To Set Carrier Amplitude

After selecting carrier waveform shape, press **Ampl/HiLevel** to highlight “Ampl”, and then use the numeric keyboard or knob to input desired amplitude. The available amplitude range is limited by **Resistant** and **Freq/Period**. Please refer to the “Output Characteristic” described in “**Specifications**”.

To Select Modulating Waveform Source

Press **Mod** → **Source** to select “Int” or “Ext” modulating waveform source.

1. Internal Source

When internal source is selected, the modulating waveform is set as a Square with 50% duty cycle, and the “shift” rate of the output amplitude between “carrier amplitude” and “modulation amplitude” is determined by “ASK Rate”.

2. External Source

When external source is selected, the generator accepts the external modulating signal from the ExtTrig connector (as shown in the picture below) at the rear panel.

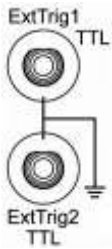

Note: The ExtTrig connector used to control ASK modulation externally is different from the Mod in/I connector used to control AM/FM/PM modulation externally. In ASK modulation, ExtTrig has an adjustable edge polarity.

To Set ASK Rate

When internal source is selected, press **ASK Rate** to set the “shift” rate at which the output amplitude shifts between “carrier amplitude” and “modulation amplitude”.

- Input the desired frequency value using numeric keyboard or knob.
- The available frequency ranges from 2 mHz to 1 MHz, and the default value is 100 Hz.

Note: This menu will be grayed out and disabled when external source is selected.

To Set Modulating Amplitude

Press **ModAmp** to set the modulating amplitude.

- Input the desired amplitude value using numeric keyboard or knob.
- The available amplitude (High Z) ranges from 0 V to 10 V, and the default value is 2 V.

To Set Modulating Polarity

Press **Polarity** to select the “Positive” or “Negative” of the modulating waveform to control the output amplitude.

When internal modulation is selected, if the polarity is “positive”, logic low of the modulating waveform amplitude corresponds to output of the smaller of the two amplitudes (modulating amplitude and carrier amplitude), while logic high corresponds to output of the greater amplitude; if the polarity is “negative”, the situation is the opposite.

When external modulation is selected, if the polarity is “positive”, logic low of the input corresponds to output of the smaller of the two amplitudes (modulating amplitude and carrier amplitude), while logic high corresponds to output of the greater amplitude; if the polarity is “negative”, the situation is the opposite.

Frequency Shift Keying (FSK)

When FSK (Frequency Shift Keying) modulation is selected, you can configure the generator to make its output frequency “shift” between two preset frequencies (“carrier frequency” and “hop frequency”). The “shift” frequency (FSK Rate) is determined by the signal level inside the instrument or from the ExtTrig connector at the rear panel.

To Select FSK Modulation

Press **Mod** → **Type** → **FSK** to enable FSK function.

- When **Mod** is enabled, **Sweep** or **Burst** will be automatically disabled (if enabled currently).
- After FSK is enabled, the instrument will generate FSK waveform with the currently specified carrier and modulating waveform.

To Select Carrier Waveform Shape

FSK carrier waveform shape could be Sine, Square, Ramp or arbitrary waveform, and the default is Sine.

- Press the front panel key **Sine**, **Square**, **Ramp** or **(Arb) → Select Wform** to select desired carrier waveform shape.
- Pulse (basic waveform), Noise and DC could not be used as carrier waveform.

To Set Carrier Frequency

After the carrier waveform shape is selected, you can press **Freq/Period** to highlight “Freq”, and then use the numeric keyboard or knob to input desired frequency value. The available carrier frequency varies with different carrier waveforms.

- Sine: 1 μ Hz to 250 MHz
- Square: 1 μ Hz to 120 MHz
- Ramp: 1 μ Hz to 5 MHz
- Arbitrary waveform: 1 μ Hz to 50 MHz

To Select Modulating Waveform Source

Press **Mod** → **Source** to select “Int” or “Ext” modulating waveform source.

1. Internal Source

When internal source is selected, the modulating waveform is set as a Square with 50% duty cycle, and the “shift” frequency at which the output frequency shifts between “carrier frequency” and “modulation frequency” is determined by “FSK Rate”.

2. External Source

When external source is selected, the generator accepts the external modulating signal from the ExtTrig connector (as shown in the picture bellow) at the rear panel.

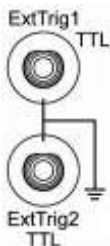

Note: The ExtTrig connector used to control FSK modulation externally is different from the Mod in/I connector used to control AM/FM/PM modulation externally. In FSK modulation, ExtTrig has an adjustable edge polarity.

To Set FSK Rate

When internal source is selected, press **FSK Rate** to set the “shift” frequency at which the output frequency shifts between “carrier frequency” and “hop frequency”.

- Input the desired rate value using numeric keyboard or knob.
- The available rate ranges from 2 mHz to 1 MHz, and the default value is 100 Hz.

Note: This menu will be grayed out and disabled when “external” source is selected.

To Set Hop Frequency

The maximum alternating frequency (“hop” frequency) depends on the current selected carrier waveform. Press **HopFreq** to highlight it, input the desire frequency value using numeric keyboard or knob.

- Sine: 1 μ Hz to 250 MHz
- Square: 1 μ Hz to 120 MHz
- Ramp: 1 μ Hz to 5 MHz
- Arbitrary waveform: 1 μ Hz to 50 MHz

To Set Modulating Polarity

Press **Polarity** to select the “Positive” or “Negative” of the modulating waveform to control the output frequency.

When internal modulation is selected, if the polarity is “positive”, logic low of the modulating waveform amplitude corresponds to carrier frequency output and logic high corresponds to hop frequency output; if the polarity is “negative”, the situation is the opposite.

When external modulation is selected, if the polarity is “positive”, logic low of the input corresponds to carrier frequency output and logic high corresponds to hop frequency output; if the polarity is “negative”, the situation is the opposite.

Phase Shift Keying (PSK)

When PSK (Phase Shift keying) modulation is selected, you can configure the generator to make its output phase “shift” between two preset phase values (“carrier phase” and “modulating phase”). The “shift” frequency (PSK Rate) is determined by the signal level inside the instrument or from the rear panel ExtTrig connector at the rear panel.

To Select PSK Modulation

Press **Mod** → **Type** → **PSK** to enable PSK function.

- When **Mod** is enabled, **Sweep** or **Burst** will be automatically disabled (if enabled currently).
- After PSK is enabled, the instrument will generate PSK waveform with the currently specified carrier and modulating waveform.

To Select Carrier Waveform Shape

PSK carrier waveform shape could be Sine, Square, Ramp or arbitrary waveform, and the default is Sine.

- Press the front panel key **Sine**, **Square**, **Ramp** or (**Arb** → **Select Wform**) to select desired carrier waveform shape.
- Pulse (basic waveform), Noise and DC could not be as carrier waveform.

To Set Carrier Phase

After carrier waveform shape is selected, press **Start Phase** to highlight it, use numeric keyboard or knob to input the desired phase. The available phase ranges from 0 ° to 360 °, the default value is 0 °.

To Select Modulating Waveform Source

Press **Mod** → **Source** to select “Int” or “Ext” modulating waveform source.

1. Internal Source

When internal source is selected, the modulating waveform is set as a Square with 50% duty cycle, and the “shift” frequency at which the output phase shifts between “carrier phase” and “modulating phase” is determined by “PSK Rate”.

2. External Source

When external source is selected, the generator accepts the external modulating signal from the ExtTrig connector (see the following figure) at the rear panel.

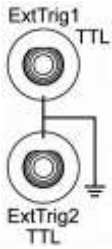

Note: The ExtTrig connector used to control PSK modulation externally is different from the Mod in/I connector used to control AM/FM/PM modulation externally. In PSK modulation, ExtTrig has an adjustable edge polarity.

To Set PSK Rate

When internal source is selected, press **PSK Rate** to set the “shift” frequency at which the output frequency shifts between “carrier phase” and “modulating phase”.

- Input the desired rate value using numeric keyboard or knob.
- The available rate ranges from 2 mHz to 1 MHz, and the default value is 100 Hz.

Note: This menu will be grayed out and disabled when external source is selected.

To Set Modulating Phase

Press **Phase** to set the modulating phase.

- Input the desired phase value using numeric keyboard or knob.
- The available phase ranges from 0 ° to 360 °, and the default value is 180 °.

To Set Modulating Polarity

Press **Polarity** to select the “Positive” or “Negative” of the modulating waveform to control the output phase.

When internal modulation is selected, if the polarity is “positive”, logic low of the modulating waveform amplitude corresponds to carrier phase output and logic high corresponds to modulating phase output; if the polarity is “negative”, the situation is the opposite.

When external modulation is selected, if the polarity is “positive”, logic low of the input corresponds to carrier phase output and logic high corresponds to modulating phase output; if the polarity is “negative”, the situation is the opposite.

Pulse Width Modulation (PWM)

A PWM (Pulse Width Modulation) modulated waveform consists of carrier waveform and modulating waveform. The pulse width of the carrier waveform varies with the instantaneous voltage of the modulating waveform.

To Select PWM Modulation

PWM can only be used to modulate Pulse. To select PWM modulation type, press the **Pulse** at the front panel first and then press **Mod** to enable PWM function.

- If the **Pulse** function key has not been selected, PWM in **Type** menu is unavailable.
- When **Mod** is enabled but the modulation type is not PWM, pressing **Pulse** will select PWM automatically.
- When **Mod** is enabled, **Sweep** or **Burst** will be automatically disabled (if enabled currently).
- After PWM is enabled, the instrument will generate PWM waveform with the currently specified carrier and modulating waveform.

To Select Pulse Waveform

As mentioned before, PWM can only be used to modulate Pulse. To select Pulse waveform, press the **Pulse** at the front panel. Notice that, the pulse in **Arb** → **Select Wform** → **Builtin** could not be used as carrier waveform.

To Set Pulse Width/Duty Cycle

After the carrier waveform shape is selected, press **Width/Duty** to highlight "Pulse Width" or "Duty Cycle" and input the desired value using numeric keyboard or knob. Pulse Width and Duty Cycle are correlative. For details, please refer to "**Pulse Width/Duty Cycle**" on page 2-7.

To Select Modulating Waveform Source

Press **Mod** → **Source** to select “Int” or “Ext” modulating waveform source.

1. Internal Source

When internal modulation source is selected, press **Shape** to select Sine, Square, Triangle, UpRamp, DnRamp, Noise or Arb as modulating waveform. The default is Sine.

- Square: Duty Cycle is 50%.
- Triangle: Symmetry is 50%.
- UpRamp: Symmetry is 100%.
- DnRamp: Symmetry is 0%.
- Arb: when the current arbitrary waveform is selected as the modulating waveform, the generator automatically limits the arbitrary waveform length as 2 kpts through sampling.

Note: Noise could be used as modulating waveform but not carrier waveform.

2. External Source

When external modulation source is selected, the **Shape** menu will be grayed out and disabled. The generator accepts the external modulating signal from the Mod in/I connector at the rear panel (as shown in the picture bellow). The “Width Deviation” (or “Duty Cycle Deviation”) is controlled by the ± 6 V signal level of the connector.

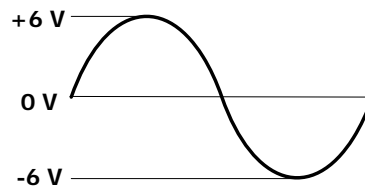
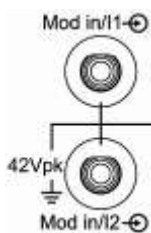

To Set Modulating Waveform Frequency

When internal modulation source is selected, press **PWM Freq** to set the frequency of the modulating waveform.

- Input the desired frequency value using numeric keyboard or knob.
- The available frequency ranges from 2 mHz to 50 kHz, and the default value is 100Hz.

Note: This menu will be grayed out and disabled when external source is selected.

To Set Pulse Width/Duty Cycle Deviation

Press **WidthDev** (or "**DutyDev**"), input the desired value using numeric keyboard or knob.

- Width Deviation represents the variation in width (in seconds) in the modulated waveform from the width of the original pulse waveform.
Pulse width range: 0 s to 500 ks.
Width deviation cannot exceed the current pulse width.
Width deviation is limited by the minimum pulse width and current edge time setting.
- Duty Cycle Deviation represents the variation in duty cycle (in %) of the modulated waveform from the duty cycle of the original pulse waveform.
Duty cycle deviation range: 0% to 50%.
Duty cycle deviation cannot exceed the current duty cycle deviation.
Duty cycle deviation is limited by the minimum duty cycle and current edge time setting.

When external source is selected, width deviation (or duty cycle deviation) is controlled by the ± 6 V signal level of the Mod in/I connector at the rear panel. For example, if the width deviation is set as 10s, +6 V signal level corresponds to 10 s width change.

Chapter 5 IQ Modulation Output

This chapter introduces how to set DG5000 to output IQ modulated waveform. DG5000 provides internal baseband source, and also accepts external I and Q modulating signals from the Mod in/I and Q connector at the rear panel. The modulated waveforms can be output from the single channel or the two channels at the same time.

Subjects in this chapter:

- IQ Modulation Overview
- To Select IQ Modulation
- To Select Carrier Waveform Shape
- To Select Modulating Waveform Source
- To Select Code Pattern
- To Set Code Rate
- IQ Mapping

IQ Modulation Overview

In IQ modulation, two orthogonal signals (carrier waveforms with the same frequency and 90 ° phase difference, usually expressed as Sin and Cos) modulate with two signals, I (In-Phase, in-phase component) and Q (Quadrature Phase, quadrature component) respectively, and then are transmitted together to improve the frequency spectrum efficiency.

In modern communication system, to improve frequency spectrum efficiency, versatile vector modulations are used, such as BPSK, QPSK and QAM. For a digital signal, it has no concept of vector. IQ modulation vectorially bridges digital signal and analog signal.

As shown in the following figure, two signals, I and Q, are multiplied by Sin and Cos respectively and then add the two together. The output is IQ modulated signal.

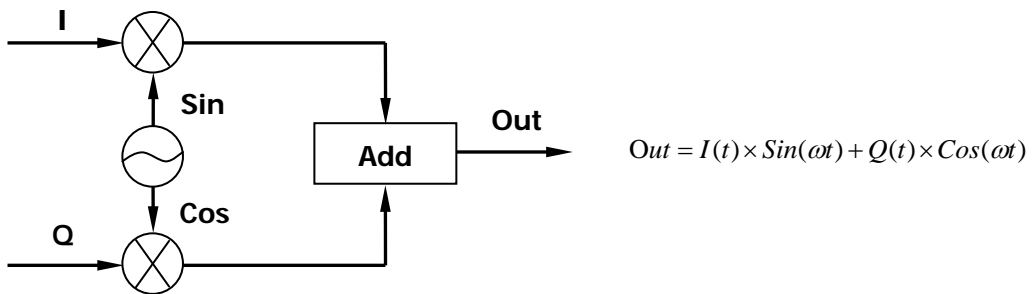

To Select IQ Modulation

Press **Mod** → **Type** → **IQ** to enable IQ modulation function.

- When **Mod** is enabled, **Sweep** or **Burst** will be disabled automatically (if enabled currently).
- After IQ is enabled, the instrument will generate IQ modulated waveform with the currently specified carrier and modulating waveform.

To Select Carrier Waveform Shape

The carrier waveform shape for IQ modulation could only be Sine waveform. To select Sine waveform, press the front panel key **Sine**.

To Select Modulating Waveform Source

Press **Mod** → **Source** to select “Int” or “Ext” modulating waveform source.

1. Internal Source

After the “internal” source is selected, the generator outputs IQ modulation waveform according to the current configuration (Pattern, Rate, and IQ_Map).

As shown in the following figure, “Rate” is the transmission rate of the code, “Pat” is the currently selected code pattern, and “IQ Map” is the method used to convert a digital signal into an analog signal. The generator operates using the code pattern in “Pat” and the specified method in “IQ Map” to acquire two modulating signals, I and Q.

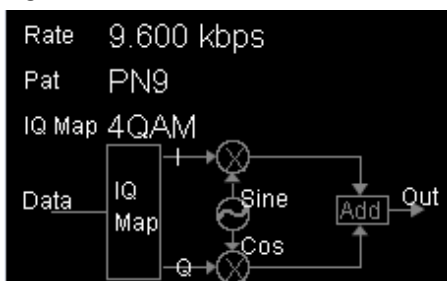

2. External Source

After the "external" source is selected, the generator accepts I and Q modulating signals from the rear panel Mod in/I and Q connectors. And then, **Pattern**, **Rate** and **IQ_Map** menus will be grayed out and disabled.

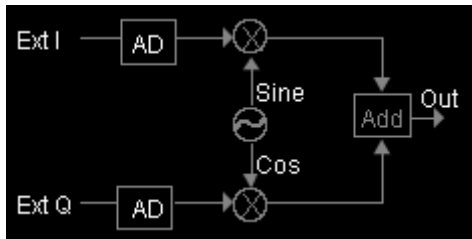

a)

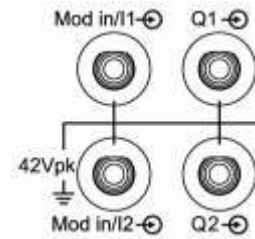

b)

As shown in figure a), the external I and Q signals are sampled by the generator and then the IQ modulating signals are acquired.

To Select Code Pattern

When internal modulation is selected, users could select the internal pre-defined or user-defined code patterns.

Pre-defined PN Sequence Code Pattern

PN sequence (Pseudo-noise Sequence, pseudo random noise sequence) is a periodic binary sequence approximation. It has some statistic characteristics similar to random noise and it can be generated and processed repeatedly. The most commonly used PN sequence is the Longest Linear Feedback Shift Register, that is, m sequence generated by shift register with linear feedback and its period is relevant to the linear feedback logic and the initial state of each register. The period of the m sequence generated by n-level shift register is $2^n - 1$.

The generator pre-defines four conventional PN sequences. When internal modulation is selected, press **Pattern** to select one PN sequence: PN9, PN11, PN15 or PN23, where 9, 11, 15 and 23 are the orders of the shift registers, and different PN code is generated based on different linear feedback.

- PN9: $Q5 \oplus Q9$.
- PN11: $Q9 \oplus Q11$.
- PN15: $Q14 \oplus Q15$.
- PN23: $Q18 \oplus Q23$.

Pre-defined Fixed 4 bits Code Pattern

Fixed4 can be used to define a 4-bits repeat sequence code pattern to provide a continuous data flow.

When internal modulation is selected, you can press **Pattern** → **Fixed4**, use knob to change the code pattern. The adjustment range is from 0000 to 1111.

User-defined Code Pattern

User could edit code pattern with up to 2000 Words (4000 Bytes) in the user space provided by DG5000.

In internal modulation mode, press Code **Pattern** → **User** to open user-defined code pattern interface.

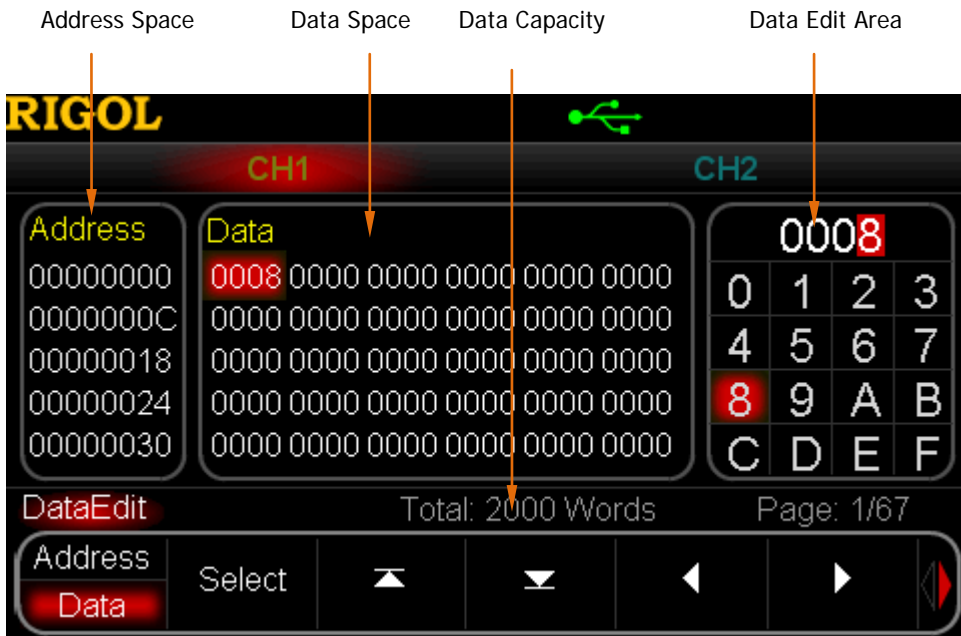

Figure 5-1 User-defined Code Pattern

As shown in the figure above, the data in “Address Space” corresponds to the data in “Data Space” respectively. A hexadecimal data occupies two address spaces, for example, the lower 8 bits of data “0008”, “08”, is stored in the address “00000000”; and the higher 8 bits, “00”, is stored in the address “00000001”.

Edit User’s Data

1. Set Data Length





As mentioned before, you could edit user’s data with up to 4000 Bytes length. If you need to set the length of your data, please press **Length** and use the numeric keyboard to enter your desired length.

2. Select Input Format

Binary format or hex format can be used in data editing. Press **InputTyp** to select "binary format" or "hex format", and the default is "hex format". When "binary format" is selected, characters from 2 to F are not available. Note that, in address editing, the **InputTyp** menu will be grayed out and disabled, and the default is "hex format".

3. Select Address or Data

Press **Address/Data** to select "Address" or "Data".

- When "Data" is selected, a data in the "Data Space" is selected (the default is the first data) and displayed in the "Data Edit Area". Use Direction Keys to select the bit to be edited. Use knob to select the desired character and then press **Select** to select this character. To edit other data in the "Data Space", use  or  to page up or down the "Data Space", and you can also use  or  to select the data to be edited.
- When "Address" is selected, an address in the "Address Space" is selected and the default is the first address "00000000". Use Direction keys and knob to input the desired address. Notice that, the purpose of inputting an address is to quickly find the data to be edited. After the address is input, press **Address/Data** to select "Data" and edit the data in "Data Space" according to the method mentioned above. The address range is from 00000000 to 00000FA0 and only even address is valid.

Save/Read User's Data

After finishing editing user's data, press **StoreRecall** to enter the Save/Recall interface, and then save the edited data as vector data file (*.RVF). You can also recall the stored digital waveform file. For details, please refer to the introduction in "**Store and Recall**".

Application of User's Data

After finishing editing user's data, press **OK** to configure the generator to output the edited user's data directly.

To Set Code Rate

Users can set the transmission rate of the code.

When internal modulation is selected, press **Rate** and use the numeric keyboard or knob to modify the value. The available range is from 1 bps to 1 Mbps, and the default value is 9600 kbps.

IQ Mapping

As mentioned before, IQ modulation vectorially bridges the digital signal and the analog signal. IQ mapping is the description of the function of the bridge.

DG5000 provides versatile multilevel digital modulation types (4QAM, 8QAM, 16QAM, 32QAM, 64QAM, BPSK, QPSK, OQPSK, 8PSK, 16PSK).

MPSK signals (BPSK, QPSK, OQPSK, 8PSK, 16PSK) can be described by vector graphs, and the endpoints of the vector are distributed on a circle. MQAM signals (4QAM, 8QAM, 16QAM, 32QAM, 64QAM) can be described by constellations. Constellation is usually a rectangle or crisscross and when $M=4, 8, 16, 32, 64$, the constellations are rectangles.

1. 4QAM (4-Quadrature Amplitude Modulation)

In internal modulation mode, press **Mapping Select** to select a modulation type such as 4QAM.

The constellation of 4QAM is as shown below:

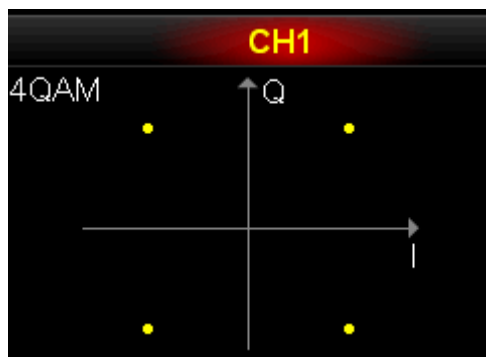





(Graph Mode)

The figure shows a parameter mode display for 4QAM. The title is 'CH1' in red. Below it, a table is displayed with the following data:

4QAM	I	Q
000000	1.0000	1.0000
000001	-1.0000	1.0000
000010	-1.0000	-1.0000
000011	1.0000	-1.0000

(Parameter Mode)

Press **Mapping Edit** to open the IQ mapping edit interface. As shown in the figures above, 4QAM has four states, 00, 01, 10 and 11, corresponding to four groups IQ components.

Use , ,  or  to select the data to be edited, use the knob to change the corresponding value, and the unit is V by default. The setting range of each IQ component is from -1 V to 1 V.

Pressing the softkey **Default** could restore the mapping relationship to its default state.

Press **OK** to confirm the edited data and return to the previous menu. Then the generator will modulate the carrier waveform according to the current configuration and output the IQ modulated signal.

The vector graphs/constellations and mapping tables of other modulation types are as following:

2. 8QAM (8-Quadrature Amplitude Modulation)

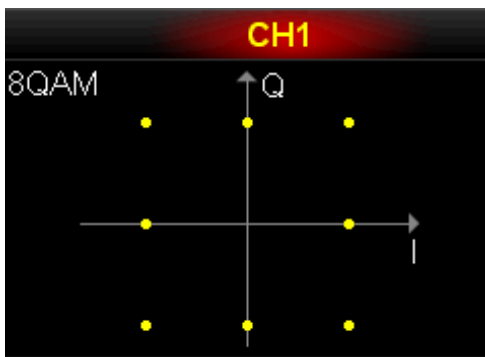

8QAM	I	Q
000000	0.0000	0.0000
000001	1.0000	1.0000
000010	0.0000	1.0000
000011	-1.0000	1.0000

3. 16QAM (16-Quadrature Amplitude Modulation)



16QAM	I	Q
000000	0.3333	0.3333
000001	1.0000	0.3333
000010	0.3333	1.0000
000011	1.0000	1.0000

4. 32QAM (32-Quadrature Amplitude Modulation)

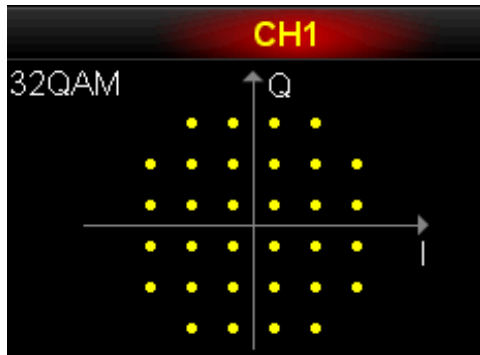

CH1

32QAM	I	Q
000000	0.2000	0.2000
000001	0.6000	0.2000
000010	0.6000	1.0000
000011	1.0000	0.2000

5. 64QAM (64-Quadrature Amplitude Modulation)

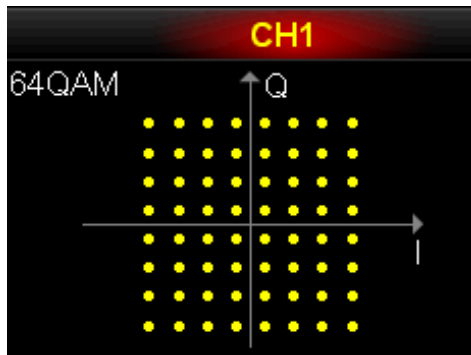

CH1

64QAM	I	Q
000000	0.1429	0.1429
000001	0.4286	0.1429
000010	0.1429	0.4286
000011	0.4286	0.4286

6. BPSK (Binary Phase Shift Keying)

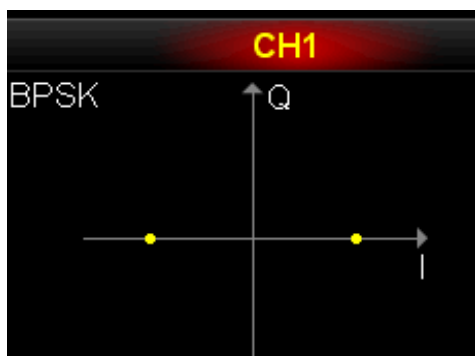

7. QPSK (Quadrature Phase Shift Keying)



8. OQPSK (Offset Quadra Phase Shift Keying)

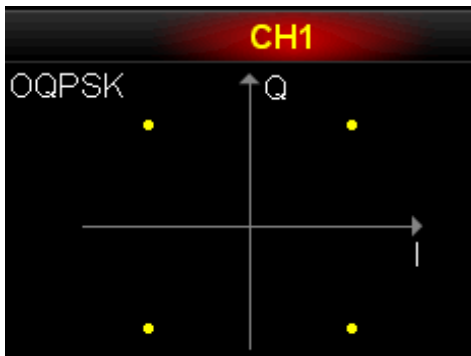

9. 8PSK (8-Phase Shift Keying)

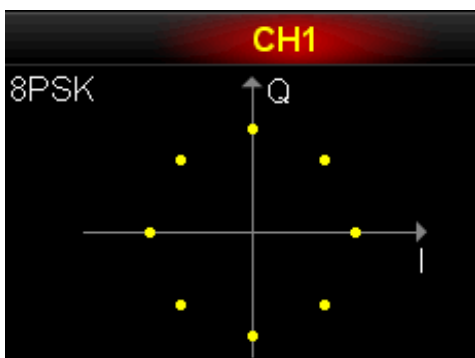

10. 16PSK (16- Phase Shift Keying)

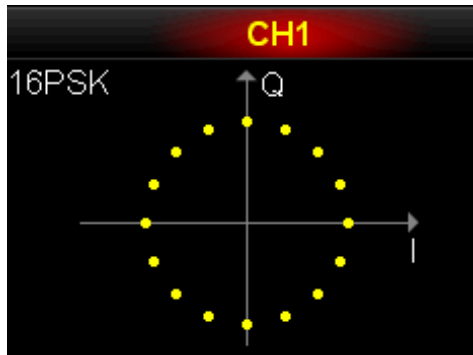

Chapter 6 Frequency Sweep Output

DG5000 could output Sweep waveform from the single channel or the two channels at the same time. In Sweep mode, the generator outputs the signal variably from Start Frequency to End Frequency within the specified Sweep time. The generator supports sweeping from low to high frequency or from high to low frequency and supports three sweep types: Linear, Log and Step. Users can set "mark" frequency, Start Hold, End Hold and Return Time. It also supports internal, external or manual trigger source. It can generate sweep outputs for Sine, Square, Ramp and arbitrary waveforms (except DC).

Subjects in this chapter:

- To Enable Frequency Sweep
- Start Frequency and End Frequency
- Center Frequency and Frequency Span
- Sweep Type
- Sweep Time
- Return Time
- Mark Frequency
- Start Hold
- End Hold
- Sweep Trigger Source
- Sweep Trigger Output

To Enable Frequency Sweep

Press **Sweep** at the front panel to enable **Sweep** function (the backlight of the key goes on), and **Mod** or **Burst** function will be automatically disabled (if currently enabled). The instrument will generate the specified sweep waveform from corresponding channel according to the current configuration. You can also reset the sweep function menu. Please refer to the introduction in the following text for details.

Start Frequency and End Frequency

Start frequency and end frequency are the upper and lower limit of the frequency for frequency sweep. The generator sweeps from the start frequency to the end frequency and then returns back to the start frequency.

- Start Frequency < End Frequency: the generator sweeps from low frequency to high frequency.
- Start Frequency > End Frequency: the generator sweeps from high frequency to low frequency.
- Start Frequency = End Frequency: the generator outputs with a fixed frequency.

When frequency sweep is enabled, press **Start /Center** to highlight "**Start**". Notice that, "**End**" in **End/Span** will also be highlighted. Use the numeric keyboard or knob to input the desired frequencies. By default, the start frequency is 100 Hz and the end frequency is 1 kHz. Different sweep waveform corresponds to different start frequency and end frequency ranges.

- Sine: 1 μ Hz to 250 MHz
- Square: 1 μ Hz to 120 MHz
- Ramp: 1 μ Hz to 5 MHz
- Arb: 1 μ Hz to 50 MHz

The generator will renewedly sweep from the specified "start frequency" after start frequency or end frequency is changed.

Center Frequency and Frequency Span

You can also set the frequency boundaries of frequency sweep through center frequency and frequency span.

- Center Frequency = $(\text{Start Frequency} + \text{End Frequency}) / 2$
- Frequency Span = End Frequency – Start Frequency

When frequency sweep is enabled, press **Start /Center** to highlight “Center”. Notice that, “Span” in **End /Span** will also be highlighted. Use numeric keyboard or knob to enter the desired frequency values. By default, the center frequency is 550 Hz and the frequency span is 900 Hz. Different sweep waveform corresponds to different center frequency and frequency span ranges. The lower limit value of center frequency is half of the frequency span, and the upper limit value of frequency span is twice of the center frequency.

- Sine: 1 μ Hz to 250 MHz
- Square: 1 μ Hz to 120 MHz
- Ramp: 1 μ Hz to 5 MHz
- Arb: 1 μ Hz to 50 MHz

The generator will renewedly sweep from the specified “Start Frequency” after “Center Frequency” or “Frequency Span” is changed.

Tip

In large range frequency sweep, the amplitude characteristic of the output signal is subject to alteration.

Sweep Type

DG5000 provides three sweep types, including **Linear**, **Log** and **Step**, and the default is **Linear**.

Linear Sweep

The output frequency of the instrument varies linearly in the way “several Hertz per second”. The variation is controlled by “Start Frequency”, “End Frequency” and “Sweep Time”.

When **Sweep** is enabled, press **SwpType** to select “Linear”. In the Graphic Mode, a line, which indicates the output frequency changes in linear mode, will appear on the screen (shown in the figure below).

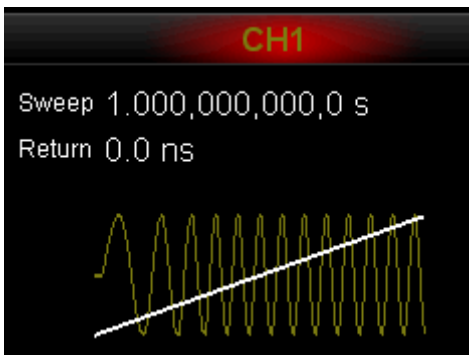

Log Sweep

The output frequency of the instrument varies in a logarithmic fashion, that is, the output frequency changes in the way of “octave per second” or “decade per second”. The change is controlled by “Start Frequency”, “End Frequency” and “Sweep Time”.

When Log Sweep is enabled, users could set the following parameters:

Start Frequency F_{start} , End Frequency F_{stop} and Sweep Time T_{sweep}

The function prototype of Log Sweep is $F_{current} = P^T$. P and T could be expressed by the above-mentioned parameters:

$$P = 10^{\lg(F_{stop} / F_{start}) / T_{sweep}}$$

$$T = t + \lg(F_{start}) / \lg(P)$$

Where, t is the time from the start of the sweep and its range is from 0 to T_{sweep} .

$F_{current}$ is the instantaneous frequency of the current output.

When **Sweep** is enabled, press **SwpType** to select “Log”. In the Graphic Mode, an exponential function curve, which indicates the output frequency changes in a logarithmic mode, will appear on the screen (shown in the figure below).

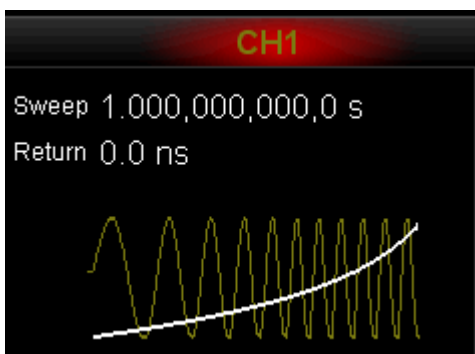

Step Sweep

The output frequency of the instrument is “stepping” from “Start Frequency” to “End Frequency”. The duration of the output signal on each frequency point is determined by “Sweep Time” and “Step Number”.

When **Sweep** is enabled, press **SwpType** to select “Step”. In Graphic Mode, a step waveform, which indicates the output frequency is changing in “step” mode, will appear on the screen (shown in the figure below). Now, use  to open the 2/2 menu page, press **StepNum** and use the numeric keyboard or the knob to set the step number. The default is 2 and the available range is from 2 to 2048. Notice that, the **StepNum** menu is grayed out and disabled in “Linear” and “Log” sweep type mode.

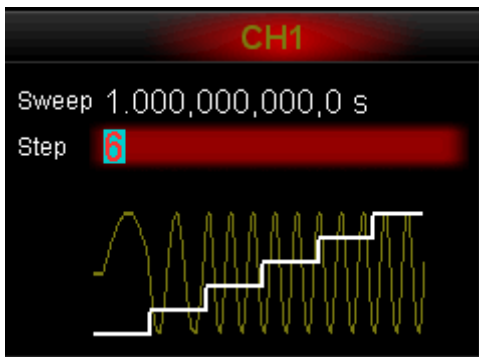

Sweep Time

When **Sweep** is enabled, press **SwpTime** and use the numeric keyboard or the knob to change the sweep time. The default value is 1 s and the available range is from 1 ms to 300 s. The generator will renewedly sweep and output from the specified "Start Frequency" once the sweep time is changed.

Return Time

The generator will always sweep from "Start Frequency" to "End Frequency" and stay within "End Hold" time. Return time describes the time in which the output backs to "Start frequency" from "End frequency" after "End hold".

When **Sweep** is enabled, press **ReturnTime** and use the numeric keyboard or the knob to change the return time. The default value is 0 s and the available range is from 0 s to 300 s.

The generator will renewedly sweep with the specified "Start Frequency" once the return time is changed.

Mark Frequency

The sync signal on the Sync connector corresponding to the channel at the rear panel always jump from low-level to high-level at the start of each sweep, and jump from high-level to low-level at the middle of the sweep period when "Mark" function is disabled or at the specified mark frequency point when "Mark" function is enabled.

When **Sweep** is enabled, press **MarkFreq** and select "On", as shown in the figure below, use the numeric keyboard or the knob to change the mark frequency. The default value is 550 Hz and the available range is limited by "Start Frequency" and "End Frequency".

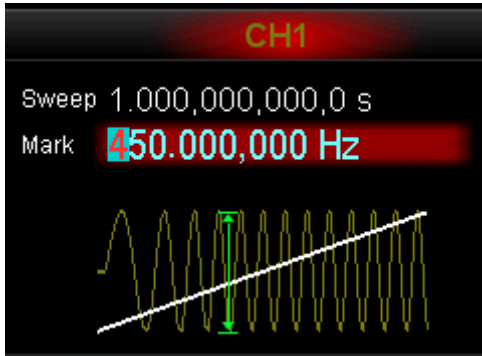

The generator will renewedly sweep and output with the specified “Start Frequency” once the Mark Frequency is changed.

Start Hold

Start Hold is the duration that the output signal outputs with the “Start Frequency” after the sweep starts. After the Start Hold, the generator will output with varying frequency in the current sweep type.

When **Sweep** is enabled, use  to open the 2/2 menu page, then press **Start Hold** and use the numeric keyboard or the knob to change the Start Hold. The default value is 0 s and the available range is from 0 s to 300 s.

The generator will renewedly sweep and output with the specified “Start Frequency” once the Start Hold is changed.

End Hold

End Hold is the duration that the output signal outputs with the “End Frequency” after the generator has swept from the “Start Frequency” to the “End Frequency”.

When **Sweep** is enabled, use  to open the 2/2 menu page, then press **End Hold** and use the numeric keyboard or the knob to change the End Hold. The default value is 0 s and the available range is from 0 s to 300 s.

The generator will renewedly sweep and output with the specified “start frequency” once the End Hold is changed.

Sweep Trigger Source

The Sweep trigger source could be internal, external or manual source. The generator will generate a sweep output when a trigger signal is received and then wait for the next trigger.

When **Sweep** is enabled, press **Source** to select “Internal”, “External” or “Manual”. The default is “Internal”.

1. Internal Trigger

The generator outputs continuous sweep waveform. The trigger period is determined by the specified sweep time, return time, start hold and stop hold times.

2. External Trigger

The generator accepts the external trigger signal from the ExtTrig connector at the rear panel. A sweep will be generated once the connector gets a TTL pulse with specified polarity. To set the TTL pulse polarity, press **SlopeIn** to select “Leading” or “Trailing”. The default is “Leading”.

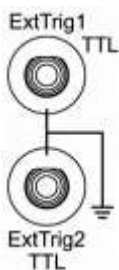

3. Manual Trigger

A sweep will be generated once you press the **Manual** for dual-channel model or you press the **Trigger** key at the front panel for single channel model.

Sweep Trigger Output

In Sweep mode, when “Internal” or “Manual” trigger source is selected, the generator will output a TTL compatible signal with specified polarity from the ExtTrig connector at the rear panel.

- Internal Trigger: the generator outputs a Square waveform with 50% duty cycle from ExtTrig connector at the beginning of the Sweep. The trigger period depends on the specified sweep time, return time, start hold and end hold.
- Manual Trigger: the generator outputs a Pulse waveform whose pulse width is greater than 1 μs from ExtTrig connector at the beginning of the Sweep.
- External Trigger: ExtTrig connector is used as an input connector and has no trigger output.

When “internal” or “manual” trigger is selected, press **TrigOut** to set the edge type of the trigger output signal. The default is “Off”.

- Off: disable the trigger output signal.
- Leading: output the trigger signal at the rising edge.
- Trailing: output the trigger signal at the falling edge.

Chapter 7 Burst Output

DG5000 could output burst waveform from the single channel or the two channels at the same time. In Burst mode, the generator could output waveform with specified cycle number and could also output "Gated" burst using external gated signal. Sine, Square, Ramp, Pulse or arbitrary waveform (except DC) can be used to generate burst. Noise could only be used for "Gated" burst.

Subjects in this chapter:

- To Enable Burst Mode
- Burst Type
- Burst Phase
- Burst Period
- Gated Polarity
- Burst Delay
- Burst Trigger Source
- Burst Trigger Output

To Enable Burst Mode

Press **Burst** at the front panel to enable **Burst** function (the backlight of the key goes on), and **Mod** or **Sweep** function will be automatically disabled (if currently enabled). The generator will output burst waveform from the corresponding channel according to the current configuration. You can also reset the burst function menu. Please refer to the introduction in the following text for details.

Burst Type

DG5000 could output three types of burst, including **N Cycle**, **Infinite** and **Gated**. The default is **N Cycle**.

N Cycle Burst

In N Cycle mode, the generator will output waveform with specified cycle number after receiving trigger signal. Waveform functions which support N Cycle mode are Sine, Square, Ramp, Pulse and arbitrary waveforms (except Noise and DC).

When **Burst** is enabled, press **Type** to select "N_Cyc". In Graphic Mode, the parameter "Cycles" on the screen is highlighted and could be edited. Use the numeric keyboard or the knob to change the Cycles, the default is 1 and the available range is from 1 to 500000.

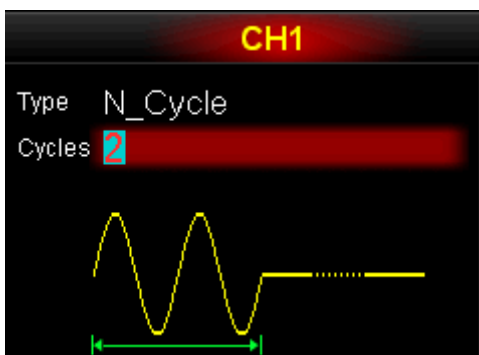

N Cycle Burst could be triggered by "Internal", "External" or "Manual" source. You can also set "**Start Phase**", "**Burst Period**" (internal trigger), "**Delay**", "**Trigger Input**" (external trigger) and "**Trigger Output**" (internal and manual triggers).

Infinite Burst

In Infinite mode, the cycle number of the waveform is set as an infinite value. The generator outputs a continuous waveform after receiving trigger signal. Waveform functions which support Infinite Burst are Sine, Square, Ramp, Pulse and arbitrary waveforms (except DC).

When **Burst** is enabled, press **Type** to select "Infinite". In Graphic Mode, an infinite cycle pulse sketch will appear on the screen.

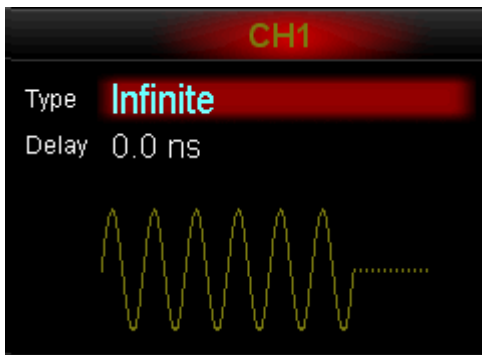

Infinite Burst could be triggered by "External" or "Manual" source. You can also set "**Start Phase**", "**Delay**", "**Trigger Input**" (external trigger) and "**Trigger Output**" (manual trigger).

Gated Burst

In Gated Mode, the generator controls the output waveform according to the external signal from the ExtTrig connector at the rear panel (as shown in the picture below). Waveform functions which support Gated Burst are Sine, Square, Ramp, Pulse, Noise and arbitrary waveforms (except DC).

When the gated signal is "True", the generator outputs a continuous waveform; when the gated signal is "False", the generator completes the current period, and then stops and holds on the voltage level corresponding to the initial burst phase of the selected waveform. For Noise waveform, the output will stop immediately once the gated signal becomes false.

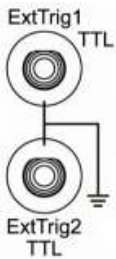

When **Burst** is enabled, press **Type** to select "Gated" and then press **Polarity** to set the gated polarity as "Positive" (or "Negative"). In Graphic Mode, you could find that the generator outputs burst waveform only when the gated signal is "positive" (or "negative").

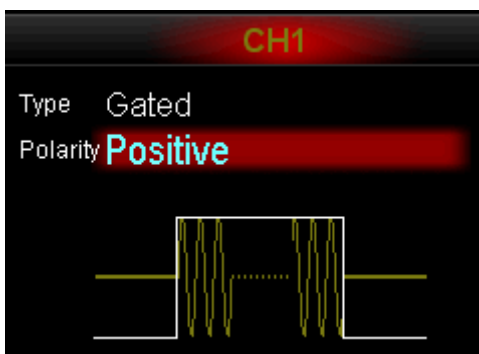

Gated Burst could only be triggered by "External" source. You can also set "Start Phase".

Burst Phase

To define the start and end points of the burst waveform.

When **Burst** is enabled, press **Start Phase** and then use the numeric keyboard or the knob to input the desired phase, the default value is 0 ° and the available range is from 0 ° to 360 °.

- For Sine, Square and Ramp, 0 ° is the point where the waveform passes through 0 V (or DC offset value) positively.
- For arbitrary waveform, 0 ° is the first point of the waveform.
- For Pulse and Noise, the **Start Phase** is unavailable.

Burst Period

Defined as the time from the beginning of the N cycle burst to the beginning of the next burst. Only for N cycle burst in internal trigger mode.

- Burst Period $\geq 1 \mu\text{s} + \text{Waveform Period} * \text{Burst Number}$. Wherein, Waveform Period is the period of the burst function (Sine, Square etc.).
- If the specified Burst Period is too small, the generator will increase it automatically to permit the output signal with specified cycle number.

When **Burst** is enabled, press **Type** → "N_Cyc" → **Source** → "Internal" → **Return** → **Burst Period** and use the numeric keyboard or the knob to input the desired period value. The default is 10 ms, and the available range is from 1 μs to 500 s.

Gated Polarity

In Gated mode, the generator will output burst at specified polarity of the gated signal received from the ExtTrig connector at the rear panel.

When **Burst** is enabled, press **Type** → "Gated" → **Polarity** to select "Positive" or "Negative". The default is "Positive".

Burst Delay

Defined as the time from when the generator receives the trigger signal to starts to output the N Cycle (or Infinite) burst. This parameter is for N cycle and infinite burst mode.

When **Burst** is enabled, press **Type** → “N_Cyc” or “Infinite” → **Delay** and use the numeric keyboard or the knob to input the desired delay. The delay is no less than 0 s and no greater than 85 s. The default is 0 s.

Burst Trigger Source

Burst trigger source could be internal, external or manual. The generator will generate a burst output when a trigger signal is received and then wait for the next trigger.

When **Burst** is enabled, press **Source** to select “Internal”, “External” or “Manual”. The default setting is “Internal”.

1. Internal Trigger

The frequency of the output burst is determined by the “Burst Period”.

2. External Trigger

The generator accepts the trigger signal from the ExtTrig connector at the rear panel (as shown in the picture below). A burst will be generated once the connector receives a TTL pulse with specified polarity. To set the TTL pulse polarity, press **SlopeIn** to select “Leading” or “Trailing” and the default setting is “Leading”.

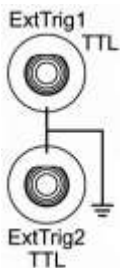

3. Manual Trigger

A burst will be generated once you press the softkey menu **Manual** for dual-channel model or the key **Trigger** at the front panel for single channel model.

Burst Trigger Output

In Burst mode, when “Internal” or “Manual” trigger source is selected, the generator will output a TTL compatible signal with specified polarity from the ExtTrig connector at the rear panel.

- Internal Trigger: the generator outputs a variable-duty cycle (relative to the carrier period and number of cycles) Square waveform from ExtTrig connector at the beginning of the Burst. The trigger period is equal to the specified burst period.
- Manual Trigger: the generator outputs a Pulse waveform whose pulse width is greater than 1 μs from ExtTrig connector at the beginning of the Burst.
- External Trigger: ExtTrig connector is used as an input connector and has no trigger output.

When “internal” or “manual” trigger is selected, you can press **Trig Out** to set the edge type of the trigger output signal. The default is “Off”.

- Off: disable the trigger output signal.
- Leading: output the trigger signal at the rising edge.
- Trailing: output the trigger signal at the falling edge.

Chapter 8 FH Output (Option)

DG5000 could output Frequency Hopping (FH) waveform from the single channel or the two channels at the same time. If you want to use FH function, please install the relevant option first.

Subjects in this chapter:

- FH Overview
- To Enable FH Function
- To Select Carrier Waveform
- FH Switch
- FH Interval
- Start Point
- Display Type
- To Load Map
- To Edit Map

FH Overview

Traditional radio communication, which works at a fixed frequency, could easily be intercepted and electrically disturbed and the security is very poor.

Frequency hopping (FH) is a spread spectrum technique which uses carrier waveform frequency hopping to realize spread frequency spectrum and is widely used in anti-interference communication system. In FH communication, the radio frequency bandwidth used for transmitting the signal is tens, hundreds even thousands times of its initial bandwidth. But for a certain time, it works at a certain frequency.

In FH communication, the pseudo-random sequence used to control carrier frequency hopping is usually called "FH Sequence". Under the control of the FH sequence, the hopping rule of the carrier frequency is called "FH Map" which reflects the change law of the carrier frequency. The commonly used FH sequences are pseudo-random sequences designed on the basis of m sequence or M sequence. The pseudo-random sequences are realized through the combination of shift register and feedback structure which has simple structure, stable performance and could be quickly synchronized.

To Enable FH Function

Press **Utility** → **CH1 Set** (or **CH2 Set**), use **◀ ▶** to open the 2/2 menu page, press **FreqHop** to enable FH function for CH1 (or CH2). The FH function setting interface is shown below.

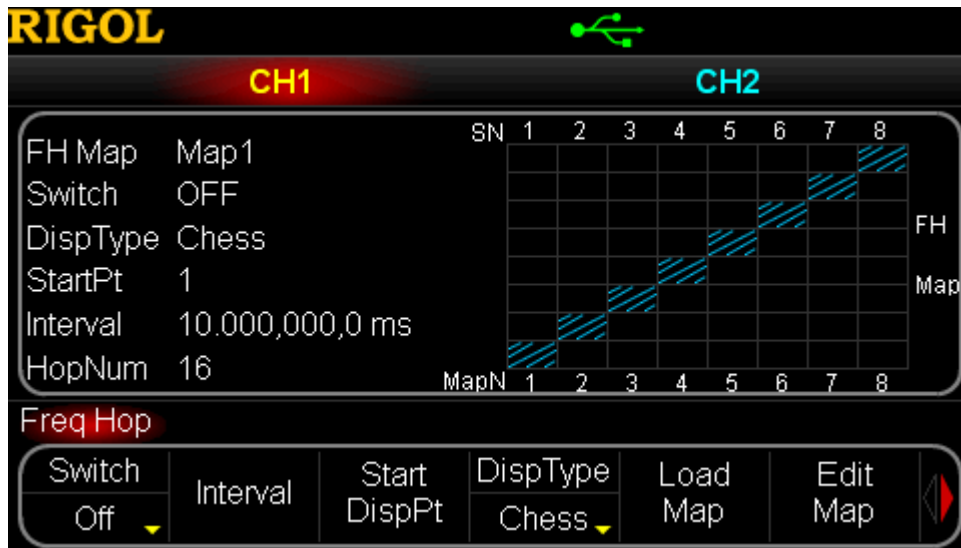

Figure 8-1 FH Function Setting Interface

- FH function is invalid when **Sweep** or **Burst** function is enabled.
- For DG5000, only Sine waveform could be used as the carrier waveform for FH. Thus, only when the Sine waveform function is enabled, could the FH function be enabled.
- When both **Mod** (only for AM or ASK) and FH are enabled, the AM carrier frequency will be varied (it will not be varied when only **Mod** is used).

To Select Carrier Waveform

As mentioned above, the allowed carrier waveform for FH is only Sine. To select Sine waveform, press **Sine**.

- If other waveform is selected, the generator will automatically turn off the FH function.
- If **Mod** is currently enabled (only for AM or ASK), press **Sine**, Sine could still be used as AM carrier waveform but its carrier frequency will be varied.
- The FH output is not relevant to the "Freq/Period" of the current Sine waveform, but is related to its "Ampl/HiLevel", "Offset/LoLevel" and "Start Phase". The FH output frequency relates to the generator model and is up to 250 MHz.

FH Switch

When FH is enabled, press **Switch** to select "On" or "Off".

- On: turn the switch on. The generator will output FH waveform from the corresponding channel according to the current setting. You could reset the function menu for FH. Please refer to the introduction in the following text.
- Off: turn the switch off.

FH Interval

FH interval is defined as the time interval that the output frequency jumps from one to another.

When FH is enabled, press **Interval** and use the numeric keyboard or the knob to input the desired value. The default is 10 ms and the available range is from 80 ns to 1 s.

Start Point

Select the start point of the FH map displayed on the screen. The selection will not change the output.

When FH is enabled, press **Start DispPt** and use the numeric keyboard or the knob to input the No. of the desired point, the available No. is limited by the current FH points (the point number of FH sequence) and the default is 1. The “Chess” or “Table” data on the screen will be updated and displayed once this parameter is changed.

Display Type

As mentioned before, FH map reflects the hopping law of the carrier frequency. For the convenience of observation, you could set the display type of FH map.

When FH is enabled, press **DispType** to select “Chess” or “Table”. The default is “Chess”.

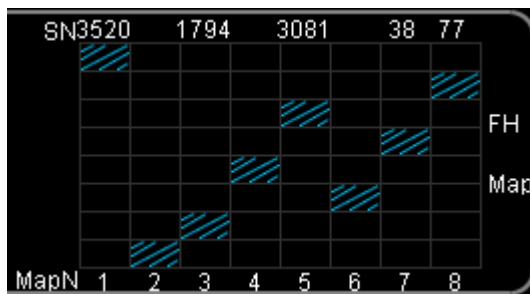

FH Map (Chess)

MapN	Freq	SN
1	200.000,000,000MHz	3520
2	2.000,000,000,000MHz	2945
3	4.000,000,000,000MHz	1794
4	8.000,000,000,000MHz	3588
5	50.000,000,000,000MHz	3081
6	6.000,000,000,000MHz	2067

The 'Table' display shows a table with 6 rows and 3 columns. The columns are labeled 'MapN', 'Freq', and 'SN'. The right side is labeled 'FH Map'.

FH Map (Table)

Figure 8-2 FH Map

The “Chess” provides a direct observation of the frequency hopping process while the “Table” visibly provides all the frequencies during the hopping process.

To Load Map

Users could load the stored FH map from internal or external memory of the instrument. When FH is enabled, press **Load Map** to select "BuiltIn", "Stored" or "Volatile".

1. Built-In Map

4 built-in FH maps (Map1, Map2, Map3 and Map4) are provided by DG5000. One of the maps will be used in the current output immediately once it is selected.

- Map1: the period is 16; with 16 hopping frequencies; normal FH sequence.
- Map2: the period is 4096; with 4096 hopping frequencies; pseudo-random FH sequence.
- Map3 and Map4: the period is 4095; with 4095 hopping frequencies; pseudo-random FH sequence.

2. Stored Map

Select waveform from internal non-volatile memory (C disk) or external memory (D or E Disk). Press this softkey to open the Store/Recall interface and the **Store/Recall** backlight at the front panel will go on. Then, select and read your desired FH file. For details, please refer to the introduction in "**Store and Recall**". After being read, the data currently stored in the volatile memory will be changed.

3. Volatile Map

Select the FH data from the volatile memory currently. Notice that, if there is no data in the volatile memory currently, this menu is not available. Then, you could edit a map in "**Edit Map**", or select a map from "BuiltIn" or "Stored" to fill the volatile memory.

To Edit Map

DG5000 permits users to define FH map and store the map in local or external memory. When FH is enabled, press **Switch** to select “Off”, and then press **Edit Map**. Users could edit the hopping frequency points of the carrier through “FH list” and control the hopping order of the carrier by editing “FH sequence”.

FH List

Press **List** to load the stored FH list from the internal or external memory of the instrument, to edit the FH list in the current volatile memory or to create a new FH list.

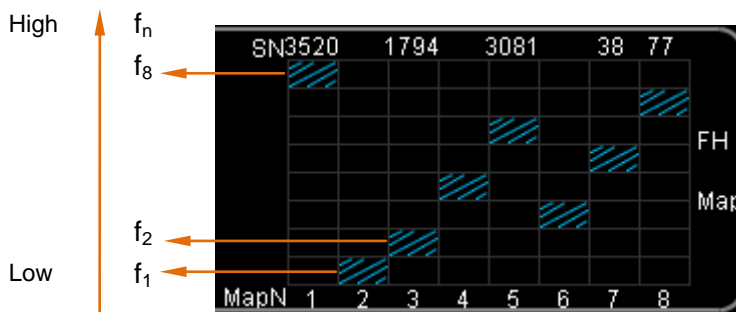

Figure 8-3 FH List in FH Map

To Load FH List

1. Built-In List

Press **Load List** → **BuiltIn** to select the FH list which contains n increasing frequency points. You could select the FH list which contains 2 (2-Point), 4 (4-Point), 8 (8-Point) or 16 (16-Point) points.

2. Stored Table

Press **Load List** → **Stored** to open the Store/Recall interface. Select and recall the stored FH list from the internal or external memory of the instrument. For details, please refer to the introduction in “**Store and Recall**”.

3. Volatile Table

Press **Load List** → **Volatile** to select the table from the current volatile memory.

To Edit List

Press **Edit List** → **Edit Point** to open the list editing interface.

1. Press **Current Point**, use the numeric keyboard or the knob to input the No. of the point to be edited (i.e. n in the figure above), and this No. is limited by the points of the current list.
2. Press **Current Freq**, use the numeric keyboard or the knob to input the frequency of the current point (i.e. f_n in the figure above), and this value is limited by the maximum output frequency of the generator.
3. Press **Return**, finish point editing and return to the previous menu.

Press **Save** to open Store/Recall interface, save the edited FH list. For detailed introduction, please refer to "**Store and Recall**".

To Create List

Press **New List** to open list create interface.

1. Press **List Points** and use the numeric keyboard or the knob to input initial points. The initial points could be up to 4096.
2. Press **Edit Point** to open the table edit interface.
 - Press **Current Point**, use the numeric keyboard or the knob to input the No. of the point to be edited, and this No. is limited by the current initial points.
 - Press **Current Freq**, use the numeric keyboard or the knob to input the frequency of the current point, and this value is limited by the maximum output frequency of the generator.
 - Press **Return**, finish point editing and return to the previous menu.
3. Press **Save** to open Store and Recall Interface, save the created FH list. For details, please refer to the introduction in "**Store and Recall**".

To Edit Sequence

Press **Edit Sequence** → **Edit Point** to open the Sequence Editing Interface.

1. Press **Current Point**, use the numeric keyboard or the knob to input the No. of the point to be edited (i.e. n in the figure above), and the No. is limited by the points number of the current sequence.
2. Press **Current Value**, use the numeric keyboard or the knob to input the sequence value of the current point (i.e. S_n in the figure above), and the value is limited by the points number of the current sequence.
3. Press **Return**, finish point editing and return to the previous menu.

Press **Save** to open Store/Recall interface, save the edited FH sequence. For details, please refer to the introduction in "**Store and Recall**".

To Create Sequence

Press **New Sequence** to open sequence creating interface.

1. Press **# Points** and use the numeric keyboard or the knob to input the initial point number, whose minimum value is 2 and maximum value is 4096.
2. Press **Edit Point** to open sequence editing interface.
 - Press **Current Point**, use the numeric keyboard or the knob to input the No. of the point to be edited, and the No. is limited by the current initial point number.
 - Press **Current Value**, use the numeric keyboard or the knob to input the sequence value of the current point, and the value is limited by the current point number.
 - Press **Return**, finish point editing and return to the previous menu.
3. Press **Save** to open Store and Recall interface, save the created FH sequence. For details, please refer to the introduction in "**Store and Recall**".

To Save FH Map

When the FH function is enabled, press **Edit Map** → **Save** to enter Store/Recall interface and store the FH map currently stored in volatile memory in local or external memory. For details, please refer to the introduction in "**Store and Recall**".

Chapter 9 Store and Recall

This chapter introduces how to store and recall waveform data or the instrument state.

Subjects in this chapter:

- Storage System Overview
- To Select File Type
- To Select Browser Type
- To Save a File
- To Recall a File
- To Copy a File
- To Paste a File
- To Delete a File or Folder
- To Create a New Folder
- Format the Local Disk
- Seamlessly Interconnection

Storage System Overview

DG5000 could store the current instrument state or waveform data in local or external memory and recall them when needed.

DG5000 provides a local and two external directories. The local directory is “C Disk” and the external directories are “D Disk” and “E Disk”.

- C Disk: with 1G Bytes capacity, provides built-in file management system which could execute conventional file operations (similar to USB storage device). The arbitrary waveform data can be downloaded to C Disk through remote command and the files in USB storage device can also be copied to C Disk.
- D Disk: when the USB Host at the front panel detects USB storage device, D disk is available. Its operation mode is the same as the C Disk’s.
- E Disk: when the USB Host at the rear panel detects USB storage device, E disk is available. Its operation mode is the same as the C Disk’s.

Press the front panel key **Store/Recall** to enable the Store/Recall function (the key backlight goes on) and open the Store/Recall interface shown as below.

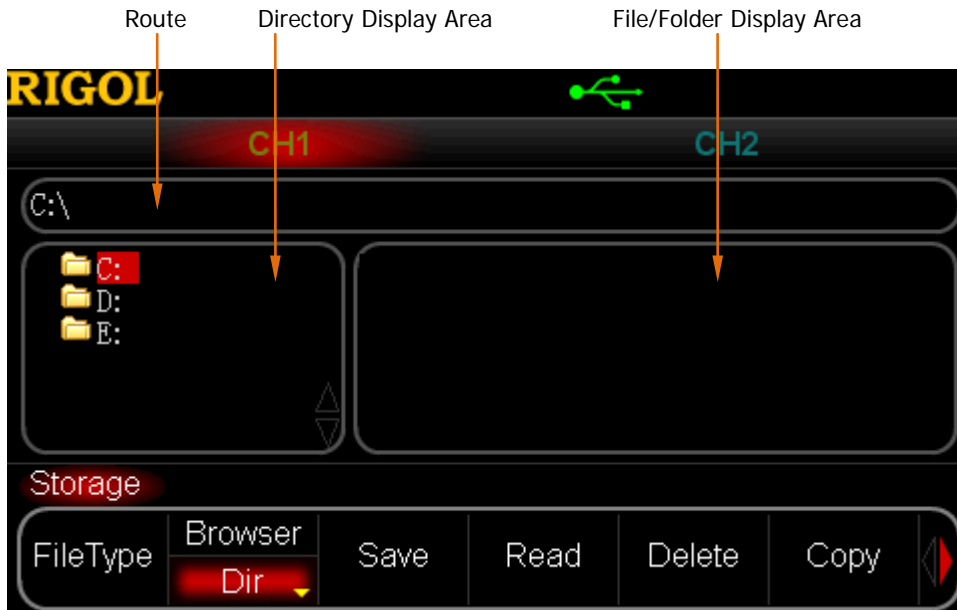

Figure 9-1 Store/Recall Interface

Note: DG5000 could identify the file whose file name consists of Chinese or English

character (including number and underline) only. If you use other characters to name the file and file holder, the Store and Recall interface could not display it normally.

To Select File Type

Press **Store/Recall** → **File Type** to select the desired file type. The file types available include: **State File**, **Arbwave File**, **Digital File**, **FH File** and **All File**.

1. State File

Store the work state of the instrument (.RSF). The status to be stored includes the waveform shapes, frequencies, amplitudes, DC offsets, duty cycles, symmetries, phases of the two channels as well as the modulation, sweep or burst parameters.

2. Arb wave File

Store the user-defined arbitrary waveform (.RAF). To edit arbitrary waveform data, please refer to the introduction in the chapter "**Arbitrary Waveform Output**".

3. Digital File

Store the user-defined digital waveform (.RDF). To edit digital waveform data, you need to install the digital module option (DG-POD-A), and press **Utility** → **Digital** → "Power On" → **User***.

4. FH File

Store the user-defined frequency hopping file, including FH Map (.RHM), FH List (.RHL) and FH Sequence (.RHS). To edit FH File, please refer to the introduction in the chapter "**FH Output (Option)**".

5. ALL File

Display all the files and folders in the currently selected directory.

To Select Browser Type

Press **Store/Recall** → **Browser** to switch “Dir” or “File”. Use the knob to select the desired directory or file and use the direction keys to fold or unfold the directory.

- Dir: switch between C, D (When USB storage device is inserted) and E (When USB storage device is inserted) disk. When this type is selected, pressing the direction keys at the front panel could fold and unfold the directory.
- File: switch between file and folder under the current directory.

To Save a File

1. To Select File Type

Select your desired file type following the introduction in “To Select File Type”. Notice, if the current file type is “All File”, the **Save** operation will be unavailable.

2. To Open the Filename Input Interface

In Store/Recall interface, set the **Browser** as “File” and then press **Save** to enter the filename inputting interface as shown below.



Figure 9-2 Filename Input Interface (English)

3. To Input Filename

Press **InType** to select “Chinese” or “English” input type. The length of the file or folder name is limited within 32 characters.

- English Inputting (including number inputting):
Press **+/-** on the numeric keyboard to switch uppercase/lowercase.
As shown in the figure above, use the knob to select desired character in the “Virtual Soft Keyboard”, and then press **Select** to select the character, and the selected character will be displayed in the “Filename Inputting Area”. Use the same method to input all the desired characters of the filename. Press **Delete** to delete the character currently marked by the cursor in “Filename Inputting Area”.
- Chinese Inputting:
Press **+/-** on the numeric keyboard to select lowercase.



Figure 9-3 Filename Input Interface (Chinese)

As shown in the figure above, use the knob to select the desired character in the “Virtual Soft Keyboard”, and then press **Select** to select the character, and the selected character will be displayed in the “Pinyin Inputting Area”. After a complete Pinyin of a Chinese character is entered, use the numeric keyboard to select the No. of the desired Chinese character in the “Chinese Character Display

Area” and the selected character will be displayed in “Filename Inputting Area”. Use the same method to input all the desired Chinese characters of the filename. Press **Delete** to first delete the character in the “Pinyin Inputting Area” and then the Chinese character currently marked by the cursor in the “Filename Inputting Area”.

4. To Save File

After finishing inputting filename in the filename input interface, press **Save**, the generator will save the file under the currently selected directory with specified filename and file type and display corresponding prompt message when the save operation succeeds.

To Recall a File

1. To Select File Type

Select the file type to be recalled following the introduction in “**To Select File Type**”. Notice, if the current file type is “All File”, the file to be recalled is the currently selected file.

2. To Select the File to be Recalled

Set **Browser** as “Dir” and use the knob to select the directory in which the file to be recalled is stored. Then set **Browser** as “File”, and use the knob to select the file to be recalled.

3. To Recall File

Press **Read**, the generator will read the currently selected file and display corresponding prompt message when the read operation succeeds.

To Copy a File

1. To Select the File to be Copied

Set **Browser** as “Dir” and use the knob to select the directory in which the file to be copied is stored. Then set **Browser** as “File”, and use the knob to select the file to be copied.

2. To Copy File

Press **Copy**, the generator will copy the file currently marked by the cursor.

To Paste a File

1. To Copy a File

Copy a file following the introduction in “**To Copy a File**”.

2. To Select Paste Destination

Set **Browser** as “Dir” and use the knob to select a paste destination directory.

3. To Paste File

Press **Paste**, the generator will paste the copied file in the current directory and display corresponding prompt message when the paste operation succeeds.

To Delete a File or Folder

1. To Select File or Folder to be Deleted

Set **Browser** as “Dir” and use the knob to select the directory in which the file or folder to be deleted is stored. Then set **Browser** as “File”, and use the knob to select the file or folder to be deleted.

2. To Delete File or Folder

Press **Delete**, the generator will delete the currently selected file or folder (empty folder).

To Create a New Folder

1. To Select Browser

In Store/Recall interface, set **Browser** as "File", use  to open the 2/2 menu page and press **New Directory** to enter the folder name inputting interface as shown below.

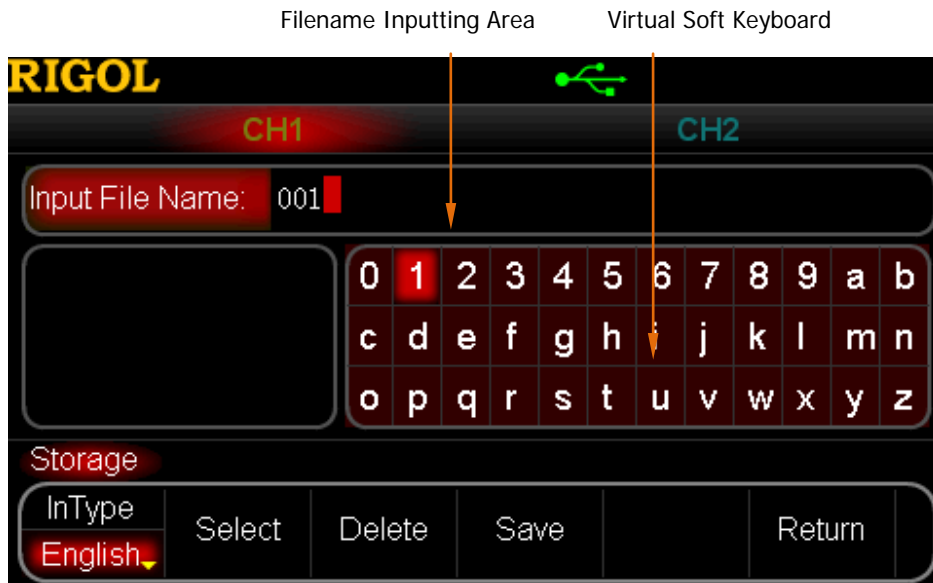

Figure 9-4 Create a New Folder

2. To Input Folder Name

Input the new folder name following the introduction in "To Save a File".

3. To Save Folder

After finishing inputting the new folder name in the folder name inputting interface, press **Save**, and the generator will create a new empty folder under the current directory.

Format the Local Disk

DG 5000 allows you to format the local disk, "C Disk". To format the local disk, select "C Disk" first, set **Browser** as "Dir" and use  to open the 2/2 menu page, then press **Format**.

Seamlessly Interconnection

DG5000 could interconnect with the **RIGOL** DS1000E series digital oscilloscope seamlessly to rebuilt and output the waveform data collected from the oscilloscope losslessly.

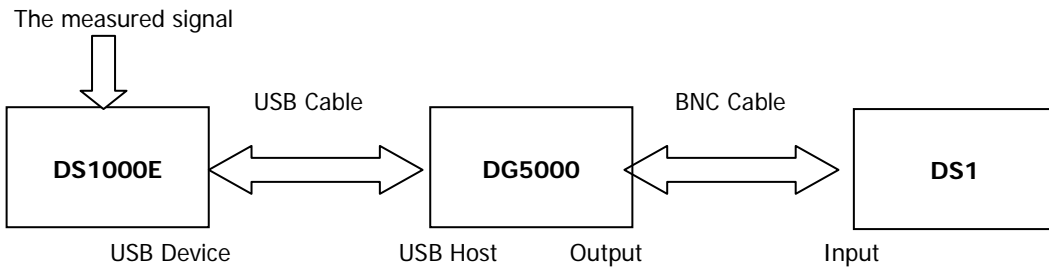

1. Make sure the measured signal is displayed stably on the screen of DS1000E.
2. Connect the USB Host interface of DG5000 to the USB Device interface of DS1000E. Now, DS1000E will enter "Remote" mode automatically.
3. Press **Store/Recall** key at the front panel of DG5000 to enter Store/Recall interface. The model identifier of DS1000E will appear in the "Directory Display Area" (refer to Figure 9-1).
4. Use the knob of DG5000 to move the focus cursor onto the model identifier of DS1000E. All channels and their on/off status of DS1000E will be displayed in the "File/Folder Display Area".
5. Set the **Browser** of DG5000 as "File", and move the cursor onto the channel to be read, and then press **Read**. DG5000 will automatically switch to arbitrary waveform mode (**Arb**) and load the waveform collected by DS1000E to the internal volatile memory of DG5000. Meanwhile, in order to protect the measured circuit, DG5000 will automatically turn off its output. When the user confirms that the current output will not damage the measured circuit and turns on the channel switch of DG5000, the generator will output the arbitrary waveform collected by DS1000E. Connect the output of DG5000 to the input of DS1 and configure DS1 to view the waveform collected by DS1000E.

Tips: The waveform data collected by the oscilloscope is stored circularly, thus the data read by DG5000 is also finite and exists discontinuousness in phase. We recommend that you display interested signal fragment in the oscilloscope screen stably, and then use DG5000 to read the data and then output through burst (**Burst**) mode.

Chapter 10 Advanced Operation

This chapter introduces the advanced operations of the generator including system parameters setting, waveform saving and printing, function expansion and the remote control interfaces configuration.

Subjects in this chapter:

- Advanced Operation Overview
- Channel Setting
- Channel Coupling
- Channel Copy
- System Setting
- Print
- Test Calibration
- To Use the Power Amplifier (Option)
- To Use the Digital Module (Option)
- To Install the Option
- To Configure the Remote Interface

Advanced Operation Overview

Press **Utility** at the front panel to open the advanced operation interface as shown below. The interface presents the current output configurations of the channels, GPIB address, Clock Source, Base Source and Frequency/Phase Deviation of Channel Coupling, Language and Power On value.

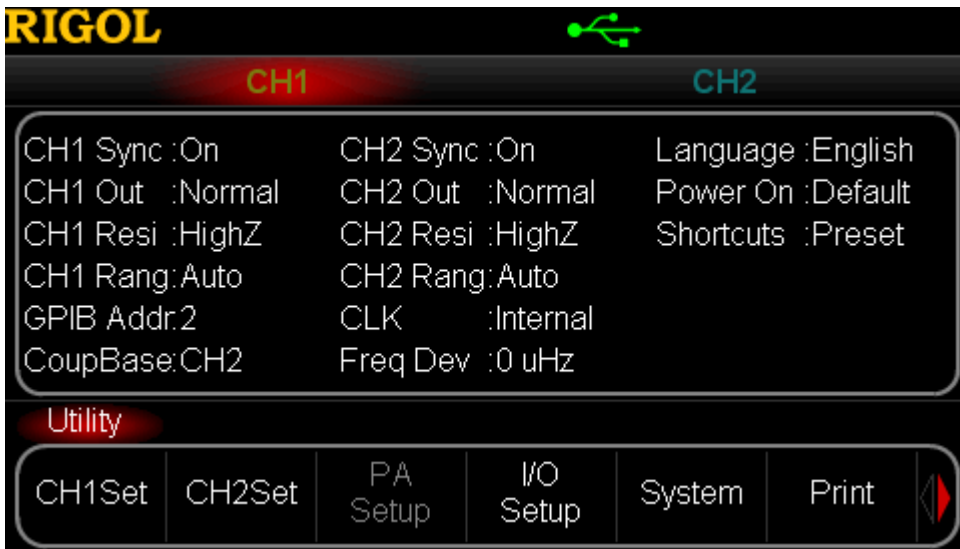

Figure 10-1 Advanced Operation Interface

1. **CH1 Set:** set the output parameters of CH1.
2. **CH2 Set:** set the output parameters of CH2.
3. **PA Setup:** set the parameters of the power amplifier. Only available when the PA is installed.
4. **I/O Setup:** set the I/O interface parameters.
5. **System:** set the system parameters.
6. **Print:** store the screen information in external USB storage device or print it using PictBridge printer.
7. **Test/Cal:** enter the system Test or Calibration operation.
8. **Coupling:** enter the Channel Coupling operation.
9. **Copy Channel:** enter the Channel Copy operation.
10. **Digital:** select the work mode of the digital module: "Power On" or "Power Off". Only available when the digital module is installed.

Channel Setting

This section takes CH1 for example to illustrate how to set the channel. The setting method for CH2 is quite the same.

Sync Setting

DG5000 could output the sync signals of basic waveform (except Noise and DC), Sweep signal, Burst signal and Modulated signal from the Sync connector, which is located at the rear panel for dual-channel model and at the front panel for single-channel.

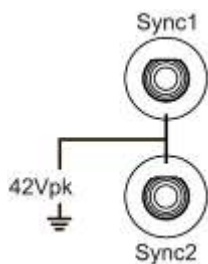

Dual-channel Model Sync Connector

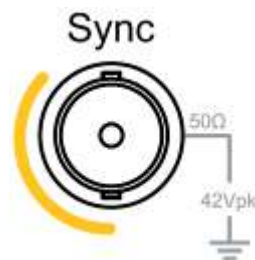

Single-channel Model Sync Connector

1. Sync On/Off

Enable or disable the sync signal on the Sync connector. Press **Utility** → **CH1Set** → **Sync** to select "On" or "Off" for the sync signal output.

By default, the sync signal is transmitted to the Sync connector (enabled). If the sync signal is disabled, the output level on the Sync connector is logic low.

2. Sync Signals of Various Waveforms

- For Sine, Square, Ramp and Pulse, the sync signal is a Square with 50% duty cycle, which is TTL high level relative to 0 V (or DC offset) when the output is positive and TTL low level relative to 0 V (or DC offset) when the output is negative. For Noise, there is no sync signal output.
- For an arbitrary waveform, the sync signal is a Square with variable duty cycle, which is TTL high level when DG5000 outputs the first downloaded waveform point.

- For AM, FM, PM, PWM and IQ, in internal modulation mode, the sync signal is a Square with 50% duty cycle and takes modulating frequency as reference. It is TTL high level in the first half period of the modulation waveform. In external mode, the sync signal is a Square with 50% duty cycle and takes the carrier waveform as reference. If the carrier waveform is arbitrary waveform, the duty cycle of the sync signal is variable.
- For ASK, FSK and PSK, the sync signal takes ASK/FSK/PSK frequency as reference and is a Square with 50% duty cycle.
- When Frequency Hopping is enabled, the sync signal, taking FH interval as reference, is a Square with 50% duty cycle.
- For Sweep, when the "Mark" is disabled, the sync signal is a Square with 50% duty cycle, which is TTL high level at the beginning of the sweep and changes to TTL low level at mid-point of the Sweep, whose frequency is corresponding to specified sweep time, start hold and stop hold times; when the "Mark" is enabled, the sync signal is TTL high level when sweep starts and transforms to TTL low level at marked frequency point.
- For a N cycle burst, the sync signal is TTL high level when burst starts and transforms to TTL low level while the specified cycle number ends (if the waveform has a relative start phase, the crossing point may not be zero). For an infinite burst, its sync signal is the same as the sync signal of a continuous waveform.
- For an external Gated burst, its sync signal follows its gated signal, which will transform to TTL low level until the last period is finished (if the waveform has a relative start phase, the crossing point may not be zero).

Sync Polarity

Set the sync signal on the Sync connector as normal or invert.

Press **Utility** → **CH1 Set** → **Polarity** to select "Positive" or "Negative". Notice that the sync signal related to the waveform is not invert even when the waveform is invert.

Output Polarity

Set the signal on the [Output] connector as normal or invert. Waveform inverts relatively to the offset voltage.

Press **Utility** → **CH1 Set** → **Output** to select "Normal" or "Invert". The default is "Normal". The first half period of the cycle waveform is positive in "Normal" mode and negative in "Invert" mode.

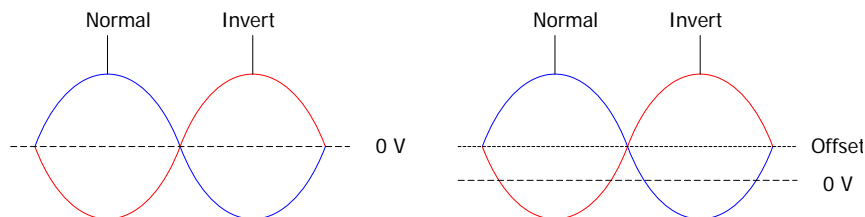

After the waveform is inverted, please pay attention to the following cases:

- None offset voltage is changed.
- The waveform viewed in Graphic mode is not invert.
- The sync signal related to the waveform is not invert.

Resistance Setting

Resistance setting is applied to output amplitude and voltage offset. For [Output] connector on the front panel, DG5000 provides a 50 Ω fixed series-connected output resistance. If the real load is different from the specified value, the displayed voltage level will not match with the voltage of the measured device. To ensure correct voltage level, the load resistance setting must match with the real load.

Press **Utility** → **CH1 Set** → **Resi** to select “HighZ” or “Load”. The default is “HighZ”. If “Load” is selected, use the numeric keyboard to set specific resistance value. The default is 50 Ω and the available range is from 1 Ω to 10 k Ω . Resistance setting will be displayed on the screen, as shown in the following figure, CH1 resistance setting is a specified value “50 Ω ” and CH2 resistance setting is “HighZ”.



- The generator will adjust the output amplitude and offset voltage automatically once the resistance setting is changed. For example, if the current amplitude is “5 Vpp”, if changing the output resistance from “50 Ω ” to “HighZ”, the displayed amplitude will be doubled and is “10 Vpp”; if the output resistance is changed from “HighZ” to “50 Ω ”, the displayed amplitude will be reduced half of the previous value and is 2.5 Vpp. Notice that only the displayed values change with the parameter; the real output from the generator does not change.
- If resistant is set as “HighZ”, the amplitude unit cannot be set as “dBm” which is grayed out and disabled.

Range Setting

Press **Utility** → **CH1 Set** → **Range** to select “Auto” or “Hold”. The default is “Auto”.

- Auto: the generator chooses the best setting for output amplifier and attenuator.
- Hold: disable automatic optimization to eliminate the waveform incontinuity caused by turning on/off the relay when altering the amplitude. But the precision of amplitude will be affected.

Attenuation Setting

This setting will attenuate (amplifier) the current amplitude following specified ratio and output the waveform. The available attenuation ratios include 1X, 2X, 5X and 10X. Press **Utility** → **CH1Set** → **Attenuat** to select desired ratio.

For example, if the current amplitude is “5 Vpp”, change the Attenuation Setting from “1X” to “2X”, and the displayed amplitude on the screen will change to “2.5 Vpp” but the real output is still “5 Vpp”.

Enable Freq Hop Function

DG5000 could output Frequency Hopping (FH) waveform from the single channel or the two channels at the same time.

Press **Utility** → **CH1Set** (or **CH2Set**) at the front panel, use  to open the 2/2 menu page, press **FreqHop** to enable FH function of CH1 (or CH2).

For detailed introduction about FH function, please refer to “**FH Output (Option)**”.

Channel Coupling

The dual-channel model of DG5000 supports coupling output of frequency or phase. When coupling is enabled, set CH1 or CH2 as the “base” channel and set the frequency or phase deviation of the two channels. Then when the frequency or phase of the base channel is changed, the corresponding parameter of the other channel will change automatically and always keeps the specified frequency or phase deviation.

Press **Utility** at the front panel, use **←** **→** to open the 2/2 menu page and press **Coupling** to enter the Channel coupling interface.

Press **Coupling** to turn “On” or “Off” the coupling function. The default is “Off”.

Press **Type** to select “FreqDev” or “PhaseDev”, and use the numeric keyboard to enter the desired value. Here, “PhaseDev” is set as “10 °”.

Set **Coupling** as “Off”, and press **Base** to select “CH1” or “CH2” as the coupling base source. Here, “CH2” is selected. Then phase relationship between CH1 and CH2 is:

$$P_{CH1} = P_{CH2} + 10^\circ$$

When the coupling function is enabled and the coupling base source is under the Freq/Phase menu mode, the screen will display a “*” mark. The figure below shows that the instrument is in phase coupling mode currently. If the phase of CH2 is changed to “0 °”, the phase of CH1 will be automatically adjusted to “10 °”.



Figure 10-2 Channel Coupling

Key Points:

- Coupling is valid only when all the two channels are in basic waveforms (Sine, Square, Ramp or arbitrary waveform) mode. But when the arbitrary waveform is "DC", the coupling is invalid.
- If the sum of the frequency or phase of the base channel and the specified deviation exceeds the upper limit of the frequency or phase of the non-base channel, the generator will automatically adjust the frequency and phase of the non-base channel to avoid parameter transfinite.
- The frequency or phase of the non-base source channel could not be directly modified.
- If the phase of the base channel is modified, the phase of the non-base channel (phase displayed on the interface) will vary accordingly. Now, the phases of the two channels are aligned without executing the **Align Phase** operation.
- The two functions, channel coupling and channel copy, are mutually exclusive. If channel coupling is enabled, **Copy Channel** menu will be grayed out and disabled.

Channel Copy

DG5000 dual-channel model supports parameters copy between its two channels. Channel copy function enables to copy the parameters (such as waveform shape, frequency and amplitude) and output setting (e.g. resistance and polarity) of one channel to the other channel.

Press the **Utility** key at the front panel, use  to open the 2/2 menu page and press **Copy Channel** to enter Channel copy interface.

Press **CH1->CH2** to copy the CH1 parameters to CH2.

Press **CH2->CH1** to copy the CH2 parameters to CH1.

Key points:

- Channel coupling and channel copy are mutually exclusive. When channel coupling is enabled, the menu **Copy Channel** will be grayed out and disabled.
- All the basic waveforms can be copied except user-defined arbitrary waveform.

System Setting

Number Format

You could set the display format of decimal point and thousands separator in number parameters on the screen. The setting is stored in nonvolatile memory. Press **Utility** → **System** → **Number Format** to enter the number format setting interface.

- Decimal Point: could be set as dot "." or comma "," and the default is dot ".".
- Thousands separator: could be set as "On", "Off" or "Space". The default is "On".

Number format has 6 combinations, as shown in the following figure:

Freq 1.000,000,000 kHz	Dot + ON (Comma)
Freq 1.000 000 000 kHz	Dot + Space
Freq 1.000000000 kHz	Dot + OFF
Freq 1,000.000.000 kHz	Comma + ON (Dot)
Freq 1,000 000 000 kHz	Comma + Space
Freq 1,000000000 kHz	Comma + OFF

Notice: Decimal point and thousands separator cannot be set as dot or comma simultaneously.

Language

At present, DG5000 supports Chinese/English Menu, Help, Interface and Input Method.

Press **Utility** → **System** → **Language** to select the desired language. The setting is stored in nonvolatile memory and will not be influenced by "Preset".

Power On Setting

Select the configuration, "Default" or "Last", which is used at when the instrument is powered on next time. The default setting is "Default".

- Last: include all the system parameters, except output configuration, clock source and the connect state of the external module.
- Default: denotes the factory default except some parameters (such as: Language).

Press **Utility** → **System** → **Power On** to select desired configuration type. The setting is stored in nonvolatile memory and will not be influenced by "Preset".

Restore Default

Restore the generator to its default configuration.

Press **Utility** → **System** → **Preset** → **OK**, the **Utility** backlight goes out. The instrument switches to Sine mode. The default values are shown in the table below. Notice that the items marked with "*" depend on the setting when factory delivery and are related to user setting during their use and will not be influenced by **Preset** operation.

Parameters	Default
Channel Parameters	
Current Carrier Waveform	Sine
Interface Mode	Parameter
Output Terminal	50 Ω
Sync Output	ON
Range Setting	Auto
Sync Polarity	Positive
Output Polarity	Normal
Attenuation Setting	X1
Coupling Switch	OFF
Coupling Base	CH2
Coupling Type	Frequency Deviation
Phase Deviation	0°
Frequency Deviation	0 Hz
Basic Waveform	
Frequency	1 kHz
Amplitude	5 Vpp
Amplitude Unit	Vpp
DC Offset	0 V _{DC}
Initial Phase	0°
Square Duty Cycle	50%
Symmetry	50%
Pulse Duty Cycle	50%
Pulse Width	500 μ s
Pulse Edge	50 ns
Arb Waveform	
Built-in Arbitrary Waveform	Sinc
Frequency Division Factor for Sample Rate	0
Arb Pulse Duty Cycle	50%
Arb Pulse Width	500 μ s
Arb Pulse Rising Edge	2 μ s

Arb Pulse Falling Edge	2 μ s
Freq Hop	
FH Switch	OFF
Display Type	Chessboard
Map Type	Map1
FH Interval	10 ms
Start Point	1
AM Modulation	
Modulating Source	Internal
Modulating Waveform	Sine
AM Frequency	100 Hz
Modulation Depth	100%
FM Modulation	
Modulating Source	Internal
Modulating Waveform	Sine
FM Frequency	100 Hz
Frequency Deviation	1 kHz
PM Modulation	
Modulating Source	Internal
Modulating Waveform	Sine
PM Frequency	100 Hz
Phase Deviation	90°
PWM Modulation	
Modulating Source	Internal
Modulating Waveform	Sine
Modulation Frequency	100 Hz
Width Deviation	200 μ s
Duty Cycle Deviation	20%
ASK Modulation	
Modulating Source	Internal

ASK Rate	100 Hz
Modulating Amplitude	2 Vpp
ASK Polarity	Positive
FSK Modulation	
Modulating Source	Internal
FSK Rate	100 Hz
Hop Frequency	10 kHz
FSK Polarity	Positive
PSK Modulation	
Modulating Source	Internal
PSK Rate	100 Hz
PSK Phase	180°
PSK Polarity	Positive
IQ Modulation	
Modulating Source	Internal
Baud Rate	9600 bps
Code Pattern	PN9
Mapping	4QAM
Sweep	
Sweep Type	Linear
Steps	2
Sweep Period	1 s
Start Hold	0 s
End Hold	0 s
Return Time	0 s
Start Frequency	100 Hz
End Frequency	1 kHz
Enter Frequency	550 Hz
Frequency Span	900 Hz
Mark Frequency	OFF
Trigger Source	Internal
Trigger Output	OFF

Trigger Input	Leading
Burst	
Burst Type	N Cycle
Cycle Number	1 Cycle
Initial Phase	0°
Burst Delay	0 s
Gated Polarity	Positive
Trigger Source	Internal
Trigger Output	OFF
Trigger Input	Leading
Trigger Period	10 ms
System Parameter	
DHCP	ON
Auto IP	ON
Manual IP	OFF
Beep	ON
Power On Setting	Default
Screen Saver	ON
Clock Source	Internal
Decimal Point	Dot
Thousand Separator	Comma
Brightness*	Factory Delivery Setting
Color*	Factory Delivery Setting
Language*	Factory Delivery Setting
Shortcut Key*	Preset

Display Setting

You could set the screen brightness and the background color of the selected parameter or menu for DG5000. Press **Utility** → **System** → **Display** to enter the Display setting interface.

1. Brightness Setting

Press **Light** and use the knob to change the brightness. The available range is from 5% to 100%. The length of the brightness indicator bar will vary when the brightness is changed, as shown in the figure below.

This setting is stored in non-volatile storage and will not be influenced by "Preset".



2. Color Setting

Press **Color** and use the knob to select your desired color. There are 10 colors for selection. When different color (Figure A) is selected, the hexadecimal code (Figure B) corresponding to the color will vary accordingly and the background color of the selected parameters and menu (Figure C and D) in the interface will also vary accordingly, as shown in the picture below.

This setting is stored in non-volatile storage and will not be influenced by "Preset".





C)

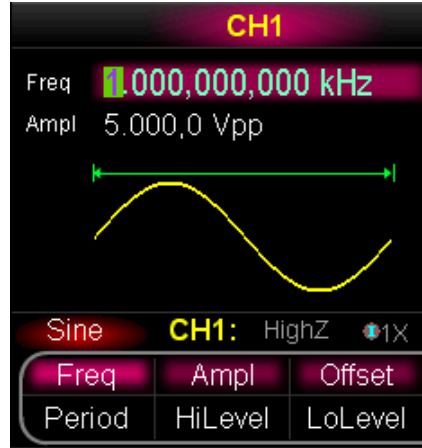

D)

Beep Setting

Enable or disable the beep caused by front panel operation or error message from remote interface.

Press **Utility** → **System** → **Beep** to select "On" or "Off". The default is "On". The current selection is stored in nonvolatile memory.

Screen Saver Setting

Enable or disable the screen saver.

Press **Utility** → **System** → **ScrnSvr** to select "On" or "Off". The default is "On". The current selection is stored in nonvolatile memory.

Clock Source Setting

DG5000 provides a 10 MHz internal clock source and also accepts external clock source input from the [10MHz In] connector at the rear panel. It can also output a 10 MHz clock source from the [10MHz Out] connector for other device to use.

Press **Utility** → **System** → **CLK** to select “Internal” or “External” (Only when valid external clock is detected, can you select “External”). The default is “Internal”.

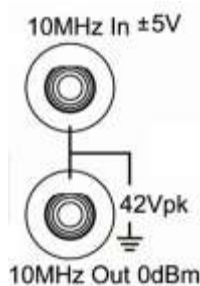

By setting clock source, synchronization can be realized between two instruments or more. “Align Phase” function is disabled when two instruments are synchronized as it only applies to align the phase relationship of the two channels in one generator. The phase relationship between two synchronous channels of different instruments can be changed by modifying the “Start Phase” of each channel after synchronization.

Sync methods for two or several instruments:

- Synchronization between two instruments:
Connect the [10 MHz Out] connector of Generator A (“Internal” clock) to the [10MHz In] connector of Generator B (“External” clock) and set the output frequencies of A and B as a same value to realize synchronization for two instruments.
- Synchronization among multi-instruments:
Divide the 10 MHz clock source of a Generator (“Internal” clock) into multiple channels, and then connect them to the [10 MHz In] connectors of other generators (“External” clock) respectively, and finally set the output frequencies of all the generators as a same value to realize synchronization for multi-instruments.

User-defined Shortcut

The **User*** key at the front panel provides a shortcut for users. You could define it as your desired function which can be recalled once you press the key in any operation interface.

To change the function recalled by this shortcut key, press **Utility** → **System** → **Shortcuts** to open the User-defined shortcut interface as shown in the following figure. Use the knob to select desired function on the interface (such as “Preset”) and press **Select**. Now, pressing the **User*** key would open the “Preset” menu.



Figure 10-3 User-defined Shortcut Interface

Note: If the system detects the digital module, the shortcut will automatically switch to “Digital”. Then, pressing the **User*** key will open the digital waveform editing interface. For detailed information about digital waveform editing, please refer to “**To Use the Digital Module (Option)**”.

System Information

Press **Utility** → **System** → **Sys Info** to view the version information of the current instrument on the system information interface.

Print

Users could store the screen graph into external USB storage device or print it using PictBridge printer. Press **Utility** → **Print** to open print setting interface.

1. To Print Screen to PictBridge Printer

Connect the PictBridge printer first. Use USB cable to connect the USB Device interface of the generator to the USB Host interface of the printer (as shown in the figure below).

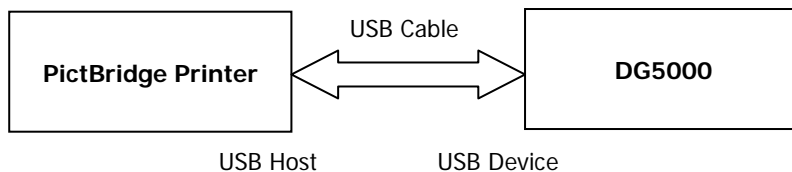

Set the Device Type to “Printer” (refer to **To Set USB Device Type**) and press **Pict Bridge** to enter the setting interface.

- **Print:** prints the screen after 10 seconds you press the key.
- **Copies:** specifies the required number of copies to be printed by using the knob. The maximum is 9999 copies.
- **Palette:** selects the picture color from “Gray” or “Color”.
- **Inverted:** enables or disables the inverse print.

2. To Store Screen to USB Storage Device

Please connect a USB storage device first. When the connection succeeds, an



icon will be displayed on the **status bar** of the screen and the corresponding prompt message will be displayed on the screen.

Press **U Disk**, a clock icon and a countdown prompt (10 s) will appear on the left of the  icon. Switching the screen to your desired image within the specified time, the generator will automatically store the image under the folder named “Rigol” (created automatically if it do not exist) in the USB storage device in bitmap form (*.BMP). If the storage operation succeeds, the screen will display corresponding prompt message.

Test Calibration

Press **Utility** → **Test/Cal** to open the test calibration interface. Users could view the self-test information. Self-calibration by users is not recommended. If you want to perform self-test and calibration, please contact **RIGOL**.

1. Self Test

When correct calibration code is input, this menu is available. After pressing this key, the instrument executes self-test. The operation lasts about 3 s.

2. TestInfo

Press this key to examine the instrument self-test information.

3. Secure Code

Press this key and use the knob and direction key to input correct calibration code.

4. Secure

The default is "On". When correct calibration code is input, the menu changes to "Off".

5. Manual Calibration

The calibration menu is available and the operation can be implemented only when correct calibration code is input.

6. Preset

When correct calibration code is input, this menu is available. After pressing this key, the instrument restores the default calibration values.

To Use the Power Amplifier (Option)

DG5000 supports the connection with and parameter configuration of the Power Amplifier (PA), which can amplify and then output the signal. To use external power amplifier, please install the PA1011 option.

PA1011 is one of the options provided for **RIGOL** DG Series Function/Arbitrary Waveform Generators, with up to 1 MHz full power bandwidth and higher than 80 V/ μ s slew rate. It can be connected with all the DG series products to quickly build test platform and can also be used as an independent power amplifier to be used with other signal generators.

Main Features of PA1011:

- Flexible and easy communicate with **RIGOL** DG Series Function/Arbitrary Waveform Generators or PC software through the USB interface;
- Enables to set the Gain (x1 or x10), Polarity (Normal or Invert), Output offset and the output status in connection with its software;
- Up to 50k Ω input impedance;
- The integrated output protection circuit (over-current protection and internal temperature abnormal protection) provided with ensures the instrument is working stably, reliable and safely;
- Compact size, easy to carry and use.

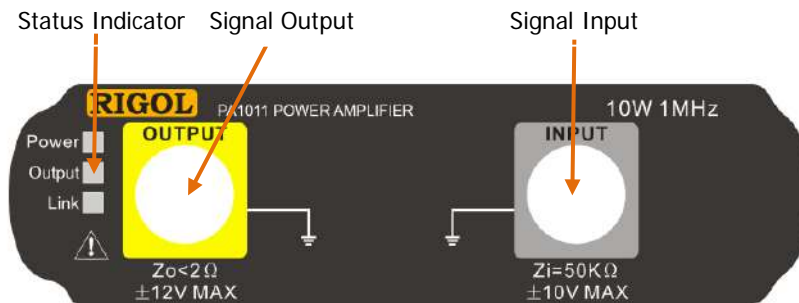
Front Panel:**Status Indicator**

Power: red light on, indicating successful power connection.

Output: green light on, indicating that output is turned on.

Link: yellow light on, indicating successful USB connection.

**CAUTION**

The input impedance of the instrument Z_i is $50k\Omega$, and the range of voltage is $-10V \sim +10V$ or $-1.25V \sim +1.25V$ separately while the voltage gain is set to X1 or X10.

Inputs that exceed these ranges may cause damages to the instrument or other hazards.

**CAUTION**

The output impedance of the instrument Z_o is less than 2Ω , and the range of output voltage is $-12V \sim +12V$. Although the amplifier actually enables to output voltages up to $\pm 12.5V$, the total wave harmonic distortion may increase.

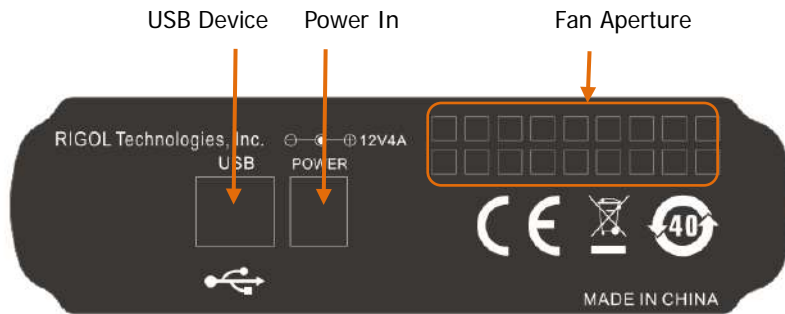
Rear Panel:**CAUTION**

Do not use any other adapters to supply power for the PA1011, or else it may cause degradation or perpetual damage.

**CAUTION**

Please make sure the vents at both sides and the fan aperture at the rear panel are visible in operation for normal working.

PA1011 Accessories:

Name	Qty.	Description
Power Cord	1	Connect the AC into the power adaptor.
AC Adaptor	1	Output 12V, 4A signals.
USB Cable	1	Connect PA1011 with DG5000.
BNC Cable	1	Connect PA1011 with DG5000.
CD-ROM	1	Provide the PC software installation program of PA1011.

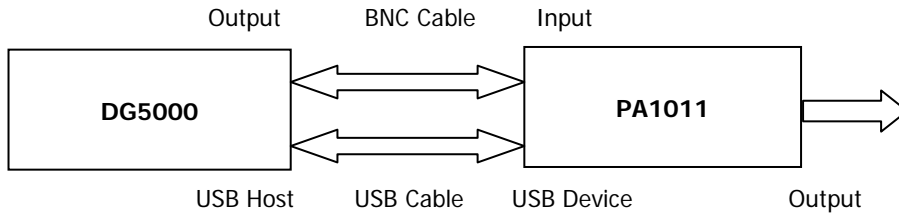
Connect DG5000 with PA1011:

When the connection succeeds, press **Utility** → **PA Setup** to open the PA parameters setting interface.

1. ON/OFF

Press this key to turn "On" or "Off" the external power amplifier. If "On" is selected, the PA amplifies and then outputs the input signal (i.e. the output signal of signal generator); if "Off" is selected, the PA has no output.

2. Gain

Press this key to select "X1" or "X10" as the amplifier gain of the signal output from the PA. "X1" means output without gain and "X10" means to amplify the signal 10 times and then output. Pay attention to distinguish it with "**Attenuation Setting**" of DG5000.

3. Output

Press this key to select "Normal" or "Invert" output mode for the signal output from the PA. Pay attention to distinguish it with "**Output Polarity**" of DG5000.

4. Deviation

Press this key to turn "On" or "Off" the output deviation output from the PA. When "On" is selected, use the numeric keyboard or knob to set deviation value. The available range is from -12 V to 12V and the default value is 0 V.

5. Storage

Press this key to store the current working state of the PA in its internal memory. When the PA is turned on the next time, it will automatically recall the stored working state.

Tip

For specifications of PA1011, refer to "**Appendix B: Specifications of Power Amplifier**".

To Use the Digital Module (Option)

DG5000 could be connected with the Digital Module (Option), which can generate arbitrary waveform based on general or user-defined protocol.

To use digital output, please install the DG-POD-A option.

DG-POD-A is a logical signal output module matching for **RIGOL** DG series Function/Arbitrary Waveform Generators, with external 16-channel data outputs and 2-channel clock outputs, making DG5000 series real Mixed Signal Generator (MSG).

Main Features of DG-POD-A:

- Provide two trigger modes: Auto, Burst;
- Support output based on four protocols: RS232, SPI, IIC and PO;
- Support user-defined protocol output based on PO;
- Support a variety of code pattern outputs: All '0', All '1', '01' turn, IEEE standard pseudo-random sequence;
- Support online data editing of protocols by users;
- Support arbitrary output rate in the "Depend" work mode;
- Support user-defined output channels, including data and clock lines (choose from 16+2);
- Support digital channel and analog channel outputs and respective setting of output or not;
- Provide TTL, LVTTTL, CMOS, LVCMOS and user-defined voltage output;
- Support remote configuration;
- Provide user online help.

Appearance and Input/output Ports:

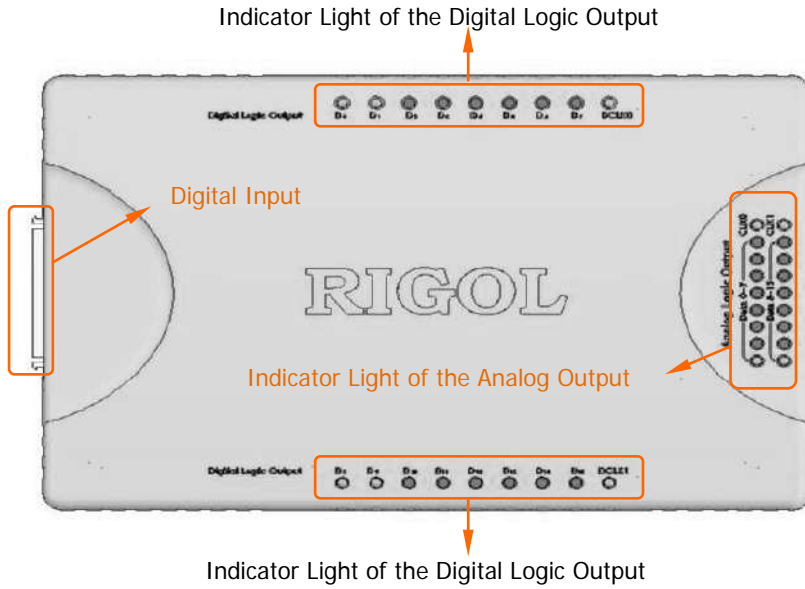

Definitions of Analog Output Ports:

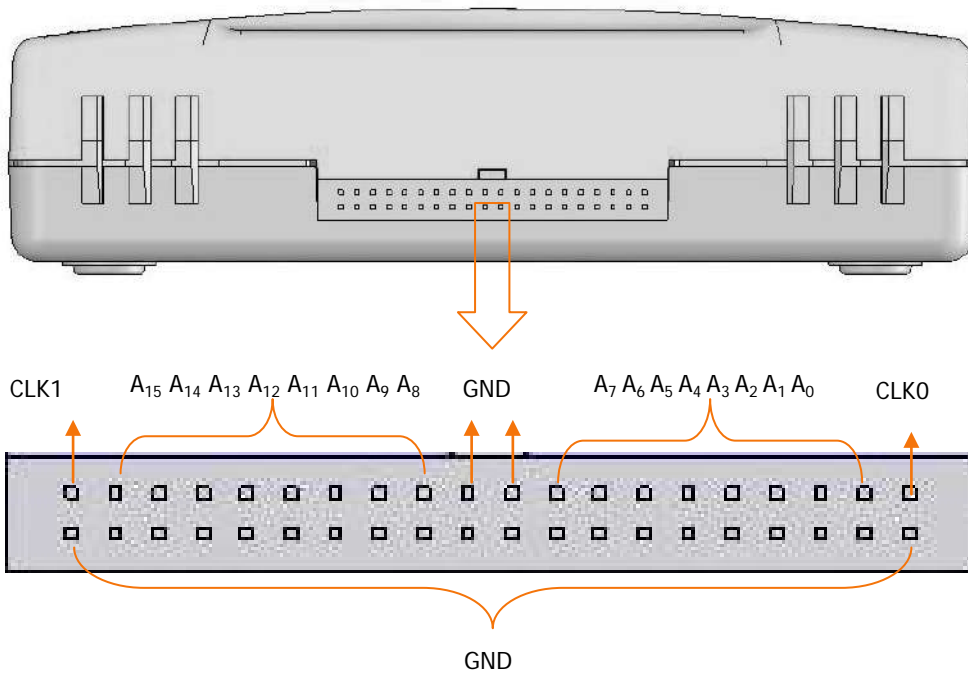

DG-POD-A Accessories:

Name	Qty.	Description
Data Flat Cable	1	Connect DG5000 and DG-POD-A.
SMB-to-SMA RF Coaxial Lines	9	Connect the digital logic output with the device under test.
Logic Analyzer Testing Lines	20	Connect the analog output with the device under test.
Logic Analyzer Testing Clips	20	Used together with the logic analyzer testing lines.

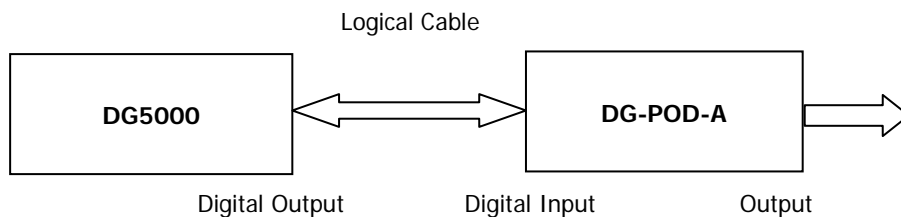
Connect DG5000 with DG-POD-A:

When the connection succeeds, if the system detects a digital module, the shortcut will be automatically switched to “Digital”. To edit digital waveform data, press **Utility** → **Digital** → “Power On” → **User***.

Press **Protocol** in the digital waveform editing interface to select the desired protocol: RS232, SPI, IIC or PO.

Tip

During digital waveform editing, **User*** blinking indicates that users need to press this key again to apply the modified setting to the output.

The following part introduces how to use the operation menu at the front panel of DG5000 to configure the digital module to realize digital signal output.

Protocol Setting

Press **Config** to open the protocol setting menu. For different protocols, different parameters are to be set.

1. RS232 Protocol Setting

When "RS232" protocol is currently selected, press **Config** to open the corresponding setting menu.

- Press **#Data** to set the transmission data length per frame to 5bits, 6bits, 7bits or 8bits.

Note, if the "#Data" set is less than 1byte (8bit), the most significant bit is dropped in the output. For example, when "#Data" is set to 7bits, the **0** (in bold) is not output when outputting the data 0x08 (**0**0001000).

- Press **Verify** to set the verification mode to None, Odd, Even, Fixed0 (the "verify" bit is always set to 0) or Fixed1 (the "verify" bit is always set to 1).
- Press **StopBit** to select 1bit, 1.5bits or 2bits.
- Press **BaudRate** to set the data transmission rate (in bps) to 2400, 4800, 9600, 19.2k, 38.4k, 57.6k, 115.2k or User. When "User" is selected, use the knob or number keypad to input the desired rate and the range available is from 1bps to 60Mbps.

2. SPI Protocol Setting

When "SPI" protocol is currently selected, press **Config** to open the corresponding setting menu.

- Press **CPOL** to select 0 or 1, wherein, 0 represents negative polarity and 1 represents positive polarity.
- Press **CPHA** to select 0 or 1, wherein, 0 represents 0° and 1 represents 180°.
- Press **#Data** to select 1Byte, 2Byte or 3Byte.

Note, data per frame (#Data) is limited by the current output data length (refer to "To Set the Output Data Length"). For example, when the output length is 1Byte, the **#Data** menu cannot be set to 2Byte or 3Byte.

- Press **Rate** and use the knob or number keypad to input the desired rate and

the range available is from 1bps to 60Mbps.

- Press **CSLevel** to select L or H, wherein, L represents low level and H represents high level.

3. IIC Protocol Setting

When "IIC" protocol is currently selected, press **Config** to open the corresponding setting menu.

- Press **Address** to select User or None to set or clear the address of the slave (host) chip from the IIC protocol.
- Press **Operate** to select Write or Read.
- Press **Rate** and use the knob or number keypad to input the desired rate and the range available is from 1bps to 15Mbps.

4. PO Protocol Setting

When "PO" is currently selected, press **Config** to open the corresponding setting menu.

- Press **Mask Chan** to select the data of any channel (D0~D15) as the tri-state mask of data output. "None" represents that no mask channel is set. The data of the mask channel (D0~D15) is from the data editing area (refer to "**User Data Editing**"). In data editing area, starting from the address 00000000, every two addresses store 16bits data (corresponding to D0~D15 of the mask channel). For example, for the data "0008", 0x08 represents D7~D0 and 0x00 represents D15~D8. The data "0" in the mask channel indicates that the data of the corresponding bit in tri-state channel is output normally while "1" indicates the output of the corresponding bit in tri-state channel is high Z (Z).
- Press **Tri-state Chan** to select one or more channels (D0~D15) as the tri-state channels. "None" represents that no tri-state channel is set. Tri-state Channel is the channel to be "masked" and the data of the tri-state channel is "masked" with the data of the mask channel for output. Whether the output of the tri-state channel is high Z or not depends on whether the data of the corresponding bit in the mask channel is "1".

For example,

Mask Channel Data:	1 0 0 1 1 0 0 1 0 1 0 1 0 1 0 0 0 0 1 0 0 1 0 0 ...
Tri-state Channel Data:	0 1 0 1 0 1 0 1 0 1 0 1 0 1 0 1 0 1 0 1 0 1 0 1 ...
Actual Output of Tri-state:	Z 1 0 Z Z 1 0 Z 0 Z 0 Z 0 Z 0 1 0 1 Z 1 0 Z 0 1 ...

- Press **BitOrder** to select LSB or MSB.
The bit order of data output depends on the protocol selected. RS232 protocol always uses LSB order, SPI and IIC protocols always use MSB order, while PO protocol can use LSB or MSB.
LSB: Least Significant Bit. For example, when the data is 00001111, D0 outputs the least bit 1 and D7 outputs the most bit 0.
MSB: Most Significant Bit. For example, when the data is 00001111, D0 outputs the most bit 0 and D7 outputs the least bit 1.
- Press **Rate** and use the knob or number keypad to input the desired rate and the range available is from 1bps to 100Mbps.

To Set the Code Pattern

Press **Pattern** to select the code pattern of the output data: ALL_0, ALL_1, 01, 8PRBS (Pseudo Random Binary Sequence), 16PRBS, 32PRBS or User (user-defined code pattern).

When "User" is selected, users can also set the starting Offset of the data output. The range of the offset is from 0 to 262143 Bytes. Offset is relative to the address, Offset=1 represents data stored in the first address (1 byte data) will not be output.

Note: The setting of the offset does not change the mask channel data under PO protocol. The first mask is always the data stored in the address 00000000 and corresponding to the mask channel set. For example, when the mask channel is set to "D3" and the data in the address 00000000 is "0x08", the first mask is "1".

User Data Editing

Press **DataEdt** to open the digital waveform editing interface (for editing method, refer to “**User-defined Code Pattern**”). Users can edit up to 131072 Words (262144 Bytes) of data. Note the user-edited data can be output only when the code pattern is set to “User”.

The storage of the data displayed in the data editing area in the internal memory is as follows:

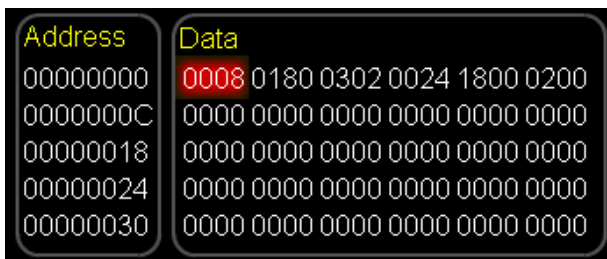

Address	Data	Address	Data
00000000	0x08	00000006	0x24
00000001	0x00	00000007	0x00
00000002	0x80	00000008	0x00
00000003	0x01	00000009	0x18
00000004	0x02	0000000A	0x00
00000005	0x03	0000000B	0x02

To Set the Output Data Length

Press **Length** and use the knob or the number keypad to set the output data length.

Output data length under different protocol has different upper limit. If the current output is user code pattern, the sum of the output data length and the user offset cannot exceed the upper limit of the user space as well as the upper limit of the protocol output. The upper limit of the user space is 262144 Bytes; the upper limit of RS232 protocol is 35840 Bytes; the upper limit of SPI protocol is 40960 Bytes; the upper limit of IIC protocol is 10240 Bytes and the upper limit of PO protocol is 131072 Byte.

As RS232, SPI and IIC are serial communication protocols, only one data output channel can be selected each time. Therefore, when the output data length is 1Byte, the single channel outputs 8bits of data. However, PO is parallel communication protocol and 16 channels can be selected to output at the same time, at this point, if the output data length is 2Bytes, each channel only outputs 1bit of the data with the total as 16bits namely 2Bytes.

Note: When using SPI protocol, if the output data length set is not a natural multiple of "#Data", the output uses zero padding mode. For example, if "Data per Frame" is set to 3Byte and output data length is set to 5Byte, 0 are added to add the data to 6Byte (2 frames) during output.

Channel Setting

Press **Channel** to open the channel setting menu of the selected protocol. Different parameters are to be set for different protocols. The module provides 16 data channels and 2 clock channels. Users can select the desired data channel and clock channel and set the channel voltage.

1. Channel Setting under RS232 Protocol

When "RS232" protocol is currently selected, press **Channel** to open the corresponding setting menu.

- Press **TX** to select any channel (D0~D15) as the data line of RS232 output.
- Press **AnalogCh** to select On or Off. When "On" is selected, the analog channel voltage (2.0V to 4.5V) of the digital module can be set and when "Off" is selected, the analog voltage output is turned off.

Note: RS232 voltage is negative logic and has negative voltage. While the digital channel cannot output negative voltage, it is always turned off.

2. Channel Setting under SPI Protocol

When "SPI" is currently selected, press **Channel** to open the corresponding setting menu.

- Press **SCLK** to select any channel (D0~D15) as the clock line of SPI output.
- Press **SDA** to select any channel (D0~D15) as the data line of SPI output.
- Press **CS** to select any channel (D0~D15) as the CS line of SPI output.

Note: When setting SCLK, SDA and CS, the items selected in D0~D15 cannot be selected again.

- Press **DigitCh** to select the digital channel voltage of the digital module: 1.8V, 2.5V, 3.3V, 4.0V, User or Off. When "User" is selected, the range available is from 1.4V to 4.2V.
- Press **AnalogCh** to select On or Off. When On is selected, the analog channel voltage (1.4V to 4.9V) of the digital module can be set and when "Off" is selected, the analog voltage output is turned off.

Note: When analog channel voltage is adjusted higher than 4.2V, digital channel voltage is automatically adjusted to be 3/8 of analog channel voltage. While,

when adjusting digital channel voltage, analog channel voltage is automatically set to the same value as digital channel voltage.

3. Channel Setting under IIC Protocol

When "IIC" protocol is currently selected, press **Channel** to open the corresponding setting menu.

- Press **SCLK** to select any channel (D0~D15) as the clock line of IIC output.
- Press **SDA** to select any channel (D0~D15) as the data line of IIC output.

Note: When setting SCLK and SDA, the selected items in D0~D15 can not be selected again.

- Press **DigitCh** to select the digital channel voltage of the digital module: 1.8V, 2.5V, 3.3V, 4.0V, User or Off. When "User" is selected, the range available is from 1.4V to 4.2V.
- Press **AnalogCh** to select On or Off. When On is selected, the analog channel voltage (1.4V to 4.9V) of the digital module can be set and when "Off" is selected, the analog voltage output is turned off.

Note: When analog channel voltage is adjusted higher than 4.2V, digital channel voltage is automatically adjusted to be 3/8 of analog channel voltage. While, when adjusting digital channel voltage, analog channel voltage is automatically set to the same value as digital channel voltage.

4. Channel Setting under PO Protocol

When "PO" protocol is currently selected, press **Channel** to open the corresponding setting menu.

- Press **DataLine** to open the data line setting menu. Press **Select** to select User, ALL_ON or ALL_OFF.
User: select one or more channels (D0~D15) as the data lines of PO output.
ALL_ON: turn the data output of all the channels on.
ALL_OFF: turn the data output of all the channels off.
- Press **SCLK** to select C0 or C1 as the clock line of PO output, wherein, C0 and C1 represent the DCLK0 and DCLK1 of the digital module respectively.
- Press **Phase** to select the clock phase as 0°, 90°, 180° or 270°.
- Press **DigitCh** to select the digital channel voltage of the digital module: 1.8V, 2.5V, 3.3V, 4.0V, User or Off. When "User" is selected, the range available is from 1.4V to 4.2V.

- Press **AnalogCh** to select On or Off. When On is selected, the analog channel voltage (1.4V to 4.9V) of the digital module can be set and when "Off" is selected, the analog voltage output is turned off.

Note: When analog channel voltage is adjusted higher than 4.2V, digital channel voltage is automatically adjusted to be 3/8 of analog channel voltage. While, when adjusting digital channel voltage, analog channel voltage is automatically set to the same value as digital channel voltage.

Trigger Setting

The digital module provides two trigger modes: Auto and Burst.

Auto Trigger: default trigger mode. At this point, users can press **TrigInt** and use the knob or number keypad to set the interval time and the range available is from 0s to 30s.

Burst Trigger: press **Burst** → **Source** to select "Internal", "External" or "Manual". For details, refer to the introductions in "**Burst Trigger Source**". Note, at this point, trigger interval cannot be set.

Tip

For specifications of digital module, refer to "**Appendix C: Specifications of Digital Module**".

To Install the Option

DG5000 provides frequency hopping module to spread frequency spectrum. To order this option (DG5-FH), please contact **RIGOL** and acquire the option installation file. According to the following steps, you can install this option.

Option Installation Steps:

- Save the option installation file to USB storage device.
- Start-up the instrument and insert USB storage device. And then press **Store/Recall** to enter the storage and recall interface.
- Refer to "**Store and Recall**" to read the option installation file according to the steps below in the storage and recall interface.
Select "D disk" → set the file type to "All File" → select the above file → press **Read**.

If this option is installed successfully, the corresponding prompt message will be displayed.

To Configure the Remote Interface

DG5000 is furnished with USB, GPIB (IEEE-488) and LAN interfaces. Users can configure the remote interface parameters (USB parameters needn't to be configured) to control DG5000 remotely.

Press **Utility** → **I/O Setup** to open the interface setting menu. You can set the GPIB address or LAN interface parameters or select the type of device connected to the USB interface.

To Set GPIB Address

Each device on the GPIB (IEEE-488) interface must have a unique address.

Press **Utility** → **I/O Setup** → **GPIB Address**, and use the numeric keyboard or the knob to set the GPIB address as a value within 0 and 30, the default value is "2". The selected address is stored in nonvolatile memory.

LAN Setting

Press **Utility** → **I/O Setup** → **LAN** to open the LAN parameters configuration interface as shown in the following figure. You could examine the LAN status and configure the LAN parameters.

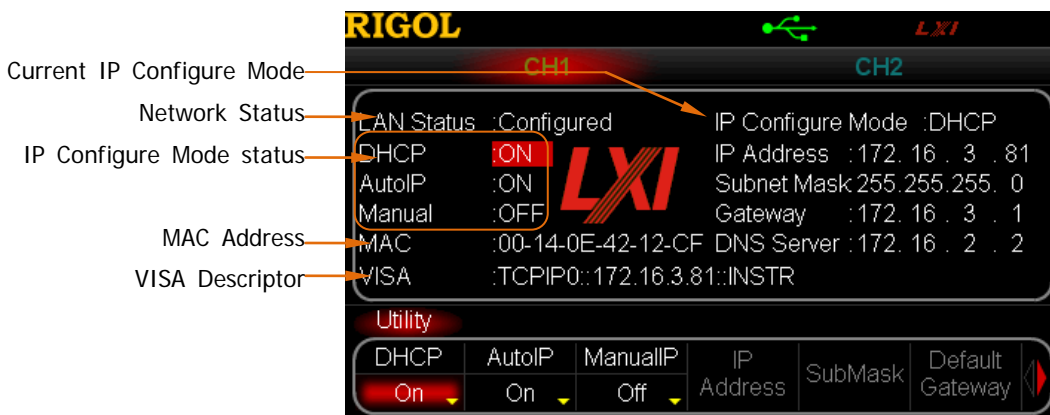

Figure 10-4 LAN Setting Interface

Network Status

Different promote messages will be provided by DG5000 based on the current network status.

- Connected: LAN connection is successful.
- Disconnect: LAN connection is unsuccessful.

MAC Address

MAC (Media Access Control) address, also called hardware address, is used for defining the position of the network device. For a generator, the MAC address is always unique. It is always used to identify the instrument while assigning IP address for instrument. MAC address (48 bits, namely 6 bytes) is usually expressed in hexadecimal format, such as 00-14-0E-42-12-CF.

VISA Descriptor

VISA (Virtual Instrument Software Architecture) is an advanced application programming interface developed by NI (National Instrument) for communications with various instrument buses. It uses the same method to communicate with instruments regardless of the types of the instrument interfaces (GPIB, USB, LAN/Ethernet or RS232). The GPIB, USB, LAN/Ethernet or RS232 instrument to communicate with VISA is called "resource".

VISA descriptor is the resource name and describes the accurate name and location of the VISA resource. If LAN interface is currently used for communication with the instrument, the VISA descriptor is TCPIP0::172.16.3.81::INSTR.

IP Configure Mode

IP configure mode could be DHCP, AutoIP or ManualIP. If the current network is disconnected, there will be nothing to display behind "IP Configure Mode:". In different IP configure modes, the configure mode for LAN parameters such as IP address will be different.

1. DHCP

- In DHCP mode, DHCP server in the current network assigns LAN parameters, e.g. IP address, for the generator.
- Press **DHCP** to select "On" or "Off" to turn DHCP mode on or off.

2. AutoIP

- In AutoIP mode, the generator acquires IP address within 169.254.0.1 and 169.254.255.254 and subnet mask 255.255.0.0 automatically based on the current network configuration.
- Press **AutoIP** to select "On" or "Off" to turn AutoIP mode on or off. When DHCP and AutoIP modes are turned on at the same time, the instrument will use DHCP mode. Therefore, to enable this mode, set DHCP as "Off".

3. ManualIP

- In ManualIP mode, the LAN parameters of the generator, e.g. IP address, are defined by users.
- Press **ManualIP** to select "On" or "Off" to turn ManualIP mode on or off. If all the three IP configuration modes are "On", the priority of parameters configuration from high to low is "DHCP", "AutoIP" and "ManualIP". Therefore, to enable this mode, set DHCP and AutoIP as "Off".
- The IP format is nnn.nnn.nnn.nnn. The first nnn ranges from 1 to 223 (except 127) and the other three nnn range from 0 to 255. We recommend that users acquire an available IP from your network administrator.
- Press **IP Address** and use the numeric keyboard and direction keys to enter your desired IP. The setting is stored in the non-volatile memory and will be loaded automatically when the generator is powered on the next time if DHCP and AutoIP are set as "Off".

Tips

- If all the three IP configure modes are "On", the priority of parameters configuration from high to low is "DHCP", "AutoIP" and "ManualIP".
- The three IP configure modes cannot be set as "Off" at the same time.

To Set Subnet Mask

In ManualIP mode, the subnet mask could be manually set.

- The format of subnet mask is nnn.nnn.nnn.nnn, where nnn ranges from 0 to 255. We recommend that users acquire an available subnet mask from your network administrator.
- Press **SubMask** and use the numeric keyboard and direction keys to enter your desired subnet mask. The setting is stored in the non-volatile memory and will be automatically loaded when the generator is powered on next time if DHCP and AutoIP are set as "Off".

To Set Default Gateway

In ManualIP mode, the default gateway could be manually set.

- The format of default gateway is nnn.nnn.nnn.nnn, where the first nnn ranges from 1 to 223 (except 127) and the other three nnn range from 0 to 255. We recommend that users acquire an available default gateway from your network administrator.
- Press **Default Gateway** and use the numeric keyboard and direction keys to enter your desired gateway address. The setting is stored in the non-volatile memory and will be automatically loaded when the generator is powered on next time if DHCP and AutoIP are set as "Off".

To Set Domain Name Server (DNS)

In ManualIP mode, the DNS could be manually set.

- The DNS format is nnn.nnn.nnn.nnn, where the first nnn ranges from 1 to 223 (except 127) and the other three nnn range from 0 to 255. We recommend that users acquire an available DNS address from your network administrator.
- Press **DNS Server** and use the numeric keyboard and direction keys to enter your desired DNS address. The setting is stored in the non-volatile memory and will be automatically loaded when the generator is powered on the next time if DHCP and AutoIP are set as "Off".

To Set Host Name

Consult your network administrator whether you need to use a host name and what is the name.

Press **Host Name** and use the numeric keyboard and direction keys to enter the host name, with up to 16 length, which could consist of letters, numbers, dot and dash. The setting is stored in the non-volatile memory.

To Set Domain Name

Consult your network administrator whether you need to use a domain name and what is the name.

Press **Domain Name** and use the numeric keyboard and direction keys to enter the domain name, with up to 16 length, which could consist of letters, numbers, dot and dash. The setting is stored in the non-volatile memory.

Default Configuration

Press **Default Config** to restore the LAN parameters to default value. By default, DHCP and AutoIP are enabled and ManualIP is disabled.

Current Configuration

Press **Current Config** to examine the MAC address of the current instrument, the current LAN parameters and LAN status information.

OK

Press **Ok** to enable the current setting of LAN parameters.

To Set USB Device Type

As mentioned before, the USB Device interface at DG5000 rear panel could be connected with PC or PictBridge printer. When different devices are used, you need to configure the generator to match the currently connected device.

Press **Utility** → **I/O Setup** → **USB Dev** to select "Computer" or "Printer" based on the currently connected device.

Chapter 11 Remote Control

At least two means can be used to control DG5000 in Remote Mode:

User-defined programming

Users can program and control DG5000 by using the SCPI (Standard Commands for Programmable Instruments) commands. For more information about the commands and programming, refer to the Programming Guide.

Use PC software

Users can use the PC software **Ultra Sigma** (from **RIGOL**) to send SCPI commands to control DG5000 remotely.

DG5000 can communicate with PC through USB, LAN and GPIB interfaces. This chapter will give a detailed introduction of how to use **Ultra Sigma** to control DG5000 remotely through various interfaces. To get the **Ultra Sigma** software and detailed operation instruction, please contact **RIGOL**.

Subjects in this chapter:

- Remote Control Via USB
- Remote Control Via LAN
- Remote Control Via GPIB

Remote Control Via USB

1. Connect the devices

Connect the generator (USB Device) with your PC using USB cable.

2. Install the USB drive

As the generator is a USB-TMC device, after you connect the generator to the PC and turn both on, the PC will display the hardware update wizard dialog box. Please install the “USB Test and Measurement Device (IVI)” driver following the directions of the wizard.

3. Search device resource

Start up Ultra Sigma, the software starts searching for the generator resources that have been automatically connected with the PC via USB, or click

USB-TMC

to search for device resources manually.

4. View the resource

The resources that have been searched successfully are shown in the “RIGOL Online Resource” catalog and the instrument model and USB information are also displayed as shown in the figure below.



5. Communicate Test

Right click the resource name such as **DG5352** (**USB0::0x1AB1::0x0640::DG53520002::INSTR**) and select **SCPI Panel Control** to open the interface below, from which you can send commands and read data.

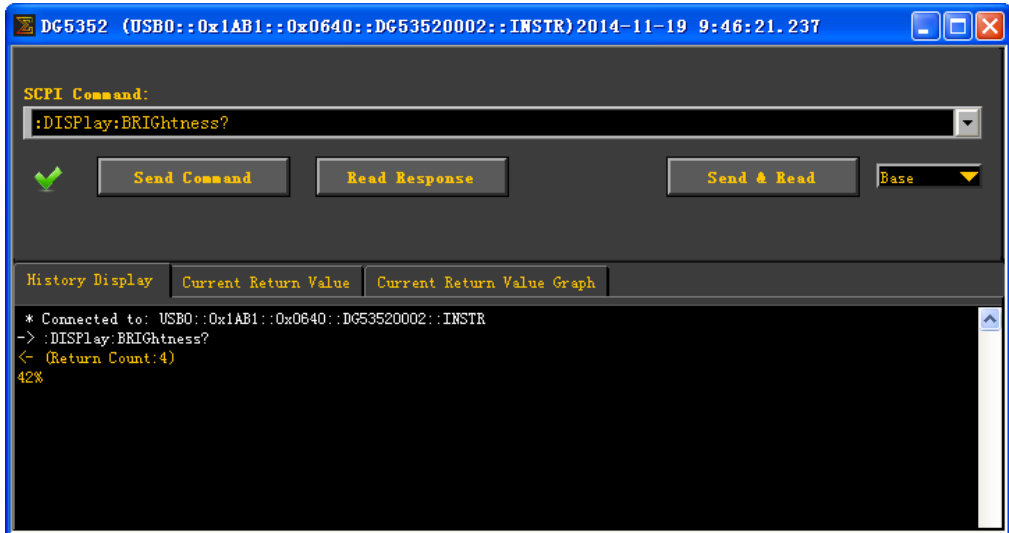

Remote Control Via LAN

1. Connect the devices

Connect the generator to your LAN using network cable.

2. Configure LAN parameters

Set the LAN parameters of the generator according to the description in “**To Configure the Remote Interface**”.

3. Search device resource

Start-up Ultra Sigma and click **LAN**, then click **Search** in the pop-up window, the software starts searching for the generator resources connected to the LAN. Instrument resources searched will be displayed in the right of the window. Select your desired resource and click **OK** to add the resource, as shown in the following figures.

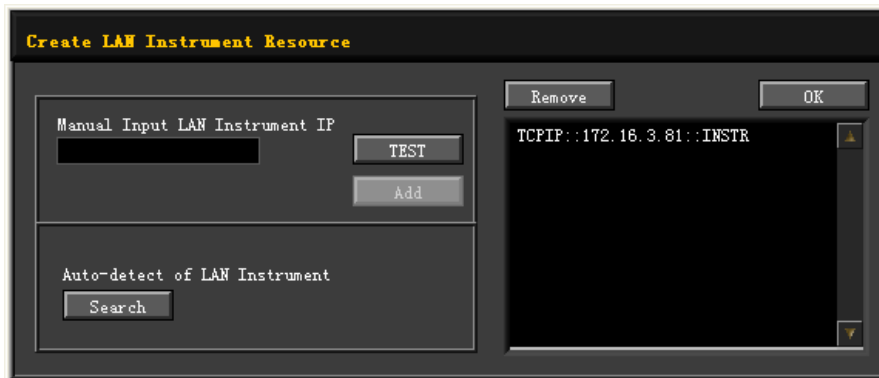
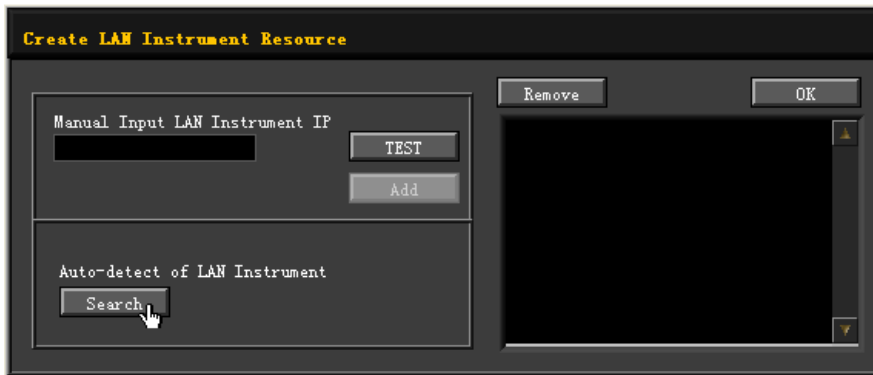

4. View the resource

The resources that have been searched successfully are shown in the “RIGOL Online Resource” catalog, as shown in the figure below.



5. Communication test

Right click the resource name such as **DG5352 (TCPIP::172.16.3.81::INSTR)** and select **SCPI Panel Control** to open the interface below, from which you can send commands and read data.

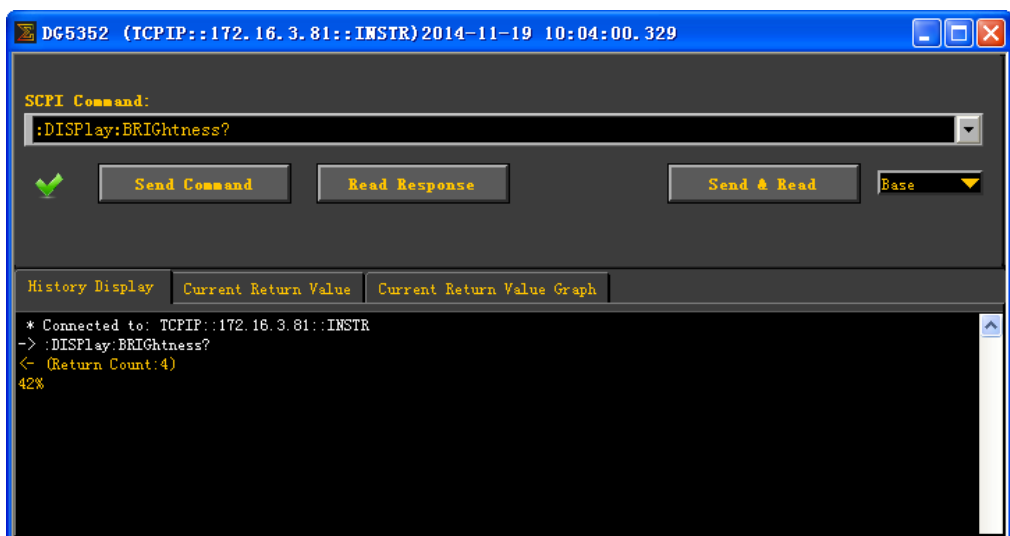

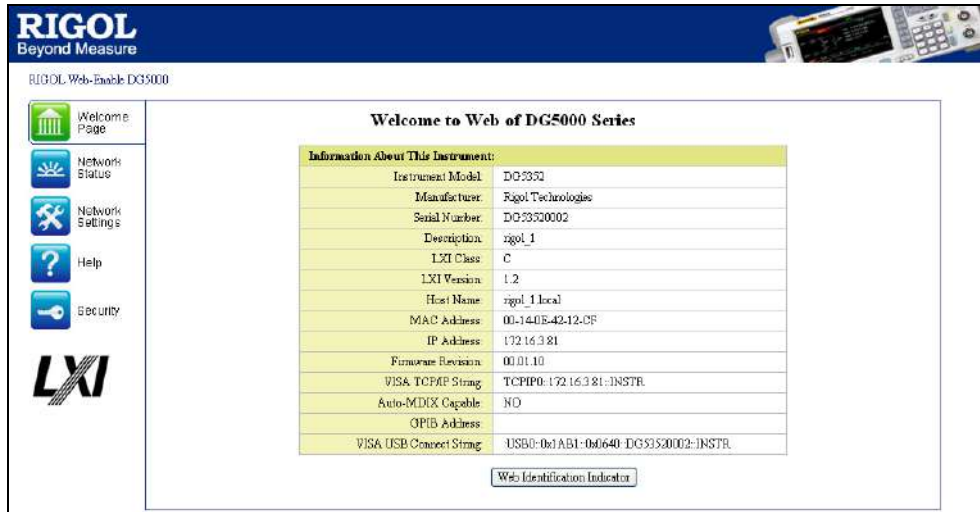

6. Load LXI webpage

The generator conforms to LXI-Class standards. You can load LXI webpage conveniently through Ultra Sigma (right-clicking the resources name and selecting “LXI-Web”). From the webpage, some important information about the generator such as the model, manufacturer, serial number, description, MAC address and IP address are shown, as the figure below.



Note: If you want to view or modify the network settings of this instrument,

please click  and input the initial password “123456” in the pop-up window (by default, the username is empty). In addition, you can click

 to reset the password.

Tips

You can also load LXI webpage by inputting the IP address of the signal generator in the address bar of the PC browser.

Remote Control Via GPIB

1. Connect the devices

Connect the generator to your PC using GPIB cable.

2. Install the device driver of the GPIB card

Install the driver of the GPIB card which has been connected to the PC correctly.

3. Set the GPIB address

Set the GPIB address of the generator according to the description in **“To Configure the Remote Interface”**.

4. Search device resource

Start up the Ultra Sigma and click  to open the panel as shown in the figure below. Then, click **Search** and the software starts searching the generator resources that have been connected to PC via GPIB automatically. When a GPIB resource is found, the name of which will be displayed on the right side of the panel.



If resources cannot be found automatically:

- Select the GPIB card address of the PC from the comboBox of “GPIB:.” and the setting GPIB address of the generator from the comboBox of “: INSTR”.
- Click “TEST” to see whether the GPIB communication works normally, if not, please follow the prompt messages step by step to solve the problem.

5. View the resource

Click  to return back to the main interface of Ultra Sigma. The resources that have been searched successfully at present are shown in the "RIGOL Online Resource" catalog.



6. Communication test

Right-click the resource name such as **DG5352 (GPIB1::1::INSTR)** and select **SCPI Panel Control** to open the interface below, from which you can send commands and read data.



Chapter 12 Troubleshooting

This chapter lists the commonly encountered failures and their solutions. When you encounter those problems, please solve them following the corresponding steps. If the problem persists, please contact **RIGOL** and provide your device information (**Utility** → **System** → **Sys Info**).



1. The screen is still dark (no display) after power on:

- (1) Check if the power is correctly connected.
- (2) Check if the power switch is really on.
- (3) Restart the instrument after finishing the above inspections.
- (4) If it does not work correctly, contact **RIGOL** for our service.

2. The screen is too dark to see the contents on the screen clearly:

- (1) Check whether the brightness setting is too low.
- (2) Press **Utility** → **System** → **Display** to enter the display setting menu. Press **Light** and rotate the knob to adjust the screen brightness properly.

3. The generator is locked:

- (1) Check whether the generator is working in remote mode ( is displayed in the status bar of the user interface). Press **Burst** to exit the remote control mode and unlock the front panel.
- (2) Check whether the generator is performing the remote lock operation of the front panel ( is displayed in the status bar of the user interface). You can send the ":SYSTEM:KLOCK OFF" command using Ultra Sigma to unlock the front panel.
- (3) Restarting the generator can also unlock the generator.

4. The settings are correct but no waveform is generated:

- (1) Check whether the BNC cable is connected to the corresponding channel output terminal (**CH1** or **CH2**) tightly.
- (2) Check whether the BNC cable has internal damage.
- (3) Check whether the BNC cable is connected to the test instrument tightly.
- (4) Check whether the backlight of **Output** (**CH1** or **CH2**) is turned on. If not, press the corresponding key to illuminate the backlight.
- (5) After finishing the above inspections, press **Utility** → **System** → **Power**

On to select "Last" and then restart the instrument.

(6) If it still does not work correctly, please contact **RIGOL**.

5. The USB storage device cannot be recognized:

- (1) Check whether the USB storage device can work normally when connected to other instruments or PC.
- (2) Make sure the USB storage device is flash type. The generator doesn't support hard drive-based USB storage device.
- (3) Restarting the instrument and insert the USB storage device again to check whether it can work normally.
- (4) If the USB storage device still cannot be used normally, please contact **RIGOL**.

6. How to set the amplitude of the waveform in dBm?

- 1) Press **CH1 | CH2** to select the desired channel.
- 2) Press **Utility** → **CH1 Set** (or **CH2 Set**) → **Resi** to check whether the setting is "HighZ". If yes, you cannot set the amplitude of the waveform in dBm at this time. Press **Resi** to select "Load" and use the numeric keyboard or direction keys and knob to set the impedance to a proper value.
- 3) Select the desired waveform, press **Ampl/HiLevel** to highlight "Ampl", and then input the desired value using the numeric keyboard. Then select the unit "dBm" from the pop-up menu.

7. Performance verification test is not passed:

- 1) Check whether the generator is within the calibration period (1 year).
- 2) Check whether the generator is warmed up for at least 30 minutes before the test.
- 3) Check whether the generator is under the specified temperature.
- 4) Check whether the test is under strong-magnetism environment.
- 5) Check whether the power supplies of the generator and test system have strong interference.
- 6) Check whether the performance of the test device used meets the requirement.
- 7) Check whether the test device used is within the calibration period.
- 8) Check whether the test devices used meets the required conditions of the corresponding manual.
- 9) Check whether all the connections are tight.

- 10) Check whether any cable has internal damage.
- 11) Make sure that the operations conform to the settings and processes which are required by the performance verification manual.
- 12) Check whether the error calculation is correct.
- 13) Correctly understand the definition of "typical value" for this product: the performance specification of this product under specified conditions.

Chapter 13 Specifications

All the specifications can be guaranteed if the following two conditions are met unless where noted.

- The generator is within the calibration period and has performed self-calibration.
- The generator has been working continuously for 30 minutes at specified temperature (18°C ~ 28°C).

All the specifications are guaranteed unless those marked with “typical”.

Model	DG5352/ DG5351	DG5252/ DG5251	DG5102/ DG5101	DG5072/ DG5071
Channel	2/1	2/1	2/1	2/1
Maximum Frequency	350 MHz	250 MHz	100 MHz	70 MHz
Sample Rate	1 GSa/s			
Waveforms				
Standard Waveforms	Sine, Square, Ramp, Pulse, Noise			
Arbitrary Waveforms	Sinc, Exponential Rise, Exponential Fall, ECG, Gauss, HaverSine, Lorentz, Dual-Tone, DC			
Frequency Characteristics				
Sine	1 μ Hz to 350 MHz	1 μ Hz to 250 MHz	1 μ Hz to 100 MHz	1 μ Hz to 70 MHz
Square	1 μ Hz to 120 MHz	1 μ Hz to 120 MHz	1 μ Hz to 100 MHz	1 μ Hz to 70 MHz
Ramp	1 μ Hz to 5 MHz	1 μ Hz to 5 MHz	1 μ Hz to 3 MHz	1 μ Hz to 3 MHz
Pulse	1 μ Hz to 50 MHz	1 μ Hz to 50 MHz	1 μ Hz to 50 MHz	1 μ Hz to 50 MHz
Noise	250 MHz Bandwidth			
Arb	1 μ Hz to 50 MHz	1 μ Hz to 50 MHz	1 μ Hz to 50 MHz	1 μ Hz to 50 MHz
Resolution	1 μ Hz			
Accuracy	± 1 ppm, 18 °C to 28 °C			
Sine Wave Spectrum Purity				
Harmonic Distortion	Typical (0 dBm) ≤ 100 MHz:	Typical (0 dBm) ≤ 100 MHz:	Typical (0 dBm) ≤ 100 MHz:	Typical (0 dBm) ≤ 70 MHz:

	<-45dBc >100MHz: <-35dBc	<-45dBc >100MHz: <-35dBc	<-45dBc	<-45dBc
Total Harmonic Distortion	<0.5% (10 Hz to 20 kHz, 0 dBm)			
Spurious (non-harmonic)	Typical (0 dBm) ≤100MHz: <-50dBc >100MHz: -50dBc+6dBc/oct ave	Typical (0 dBm) ≤100MHz: <-50dBc >100MHz: -50dBc+6dBc/oct ave	Typical (0 dBm) ≤100MHz: <-50dBc	Typical (0 dBm) ≤70MHz: <-50dBc
Phase Noise	Typical (0 dBm, 10 kHz deviation) 10 MHz: <-110 dBc			
Signal Characteristics				
Square				
Rise/Fall Time	Typical Value (1Vpp, 50Ω) <2.5 ns	Typical Value (1Vpp, 50Ω) <2.5 ns	Typical Value (1Vpp, 50Ω) <3 ns	Typical Value (1Vpp, 50Ω) <4 ns
Overshoot	Typical Value (1Vpp) <5%			
Duty Cycle	≤10 MHz: 10 MHz to 40 MHz: >40 MHz:	20.0% to 80.0% 40.0% to 60.0% 50.0% (fixed)		
Non-symmetry	1% of period +5 ns			
Jitter (rms)	Typical Value (1Vpp) ≤30 MHz: 10ppm+500 ps >30 MHz: 500 ps			
Ramp				
Linearity	≤ 0.5% of peak output			
Symmetry	0% to 100%			
Pulse				
Period	20 ns to 1000000 s			
Pulse Width	4 ns to 1000000 s			
Leading/ Trailing Edge Time	Typical Value (1Vpp, 50Ω) 2.5 ns to 1 ms	Typical Value (1Vpp, 50Ω) 2.5 ns to 1 ms	Typical Value (1Vpp, 50Ω) 3 ns to 1 ms	Typical Value (1Vpp, 50Ω) 4 ns to 1 ms

Overshoot	Typical Value (1Vpp) <5%			
Jitter (rms)	Typical Value (1Vpp) 10 ppm+500 ps			
Arb				
Waveform Length	Normal Mode: 2 to 16M points Play Mode: 2 to 128M points			
Vertical Resolution	14 bits			
Mode	Normal Mode, Play Mode			
Sample Rate	Normal Mode (Waveform Length is from 2 to 16M points): 1G Sa/s (fixed); Play Mode (Waveform Length is from 2 to 128M points): ≤1G Sa/s (variable)			
Minimum Rise/Fall Time	Typical Value (1Vpp) ≤3 ns			
Jitter (rms)	3 ns			
Interpolation Method	Close, Linear, Sinc			
Edit Method	Edit Point, Edit Block			
Non-Volatile Memory	1G Bytes			
Output Characteristics				
Amplitude (into 50 Ω)				
Range	≤100MHz: 5mVpp to 10Vpp ≤300MHz: 5mVpp to 5Vpp ≤350MHz: 5mVpp to 2Vpp	≤100MHz: 5mVpp to 10Vpp ≤250MHz: 5mVpp to 5Vpp	5mVpp to 10Vpp	5mVpp to 10Vpp
Accuracy	Typical (1 kHz Sine, 0 V Deviation, >10 mVpp, Auto) ± 1% of setting ± 1 mVpp			
Amplitude Flatness (relative to 100 kHz, 1.25Vpp Sine wave, 50Ω)	<10MHz: ±0.1dB 10MHz to 60MHz: ±0.2dB 60MHz to 100MHz: ±0.4dB 100MHz to	<10MHz: ±0.1dB 10MHz to 60MHz: ±0.2dB 60MHz to 100MHz: ±0.4dB 100MHz to	<10MHz: ±0.1dB 10MHz to 60MHz: ±0.2dB 60MHz to 100MHz: ±0.4dB	<10MHz: ±0.1dB 10MHz to 60MHz: ±0.2dB 60MHz to 70MHz: ±0.4dB

	250MHz: $\pm 1.0\text{dB}$ >250MHz: $\pm 1.5\text{dB}$	250MHz: $\pm 1.0\text{dB}$		
Units	Vpp, Vrms, dBm, High Level, Low Level			
Resolution	0.1 mV or 4 digits			
Offset (into 50 Ω)				
Range	± 5 Vpk ac + dc			
Accuracy	1% of setting + 5mV + 0.5% of amplitude			
Waveform Output				
Impedance	50 Ω (typical)			
Isolation	42 Vpk max. to Earth			
Protection	Over-temperature protected, Short-circuit protected, Overload relay automatically disables main output			
FH Characteristic				
FH Bandwidth	1.5 MHz to 250 MHz	1.5 MHz to 250 MHz	1.5 MHz to 100 MHz	1.5 MHz to 70 MHz
FH Rate	1 Hop/s to 12.5M Hop/s			
Frequency Point Numbers	4096			
Sequence Length	4096			
Modulation Characteristics				
Modulation Types	AM, FM, PM, ASK, FSK, PSK, PWM, IQ			
AM				
Carrier Waveforms	Sine, Square, Ramp, Arb (except DC)			
Source	Internal/External			
Modulating Waveforms	Sine, Square, Ramp, Noise, Arb (2 mHz to 50 kHz)			
Depth	0% to 120%			
FM				
Carrier Waveforms	Sine, Square, Ramp, Arb (except DC)			
Source	Internal/External			

Modulating Waveforms	Sine, Square, Ramp, Noise, Arb (2 mHz to 50 kHz)
PM	
Carrier Waveforms	Sine, Square, Ramp, Arb (except DC)
Source	Internal/External
Modulating Waveforms	Sine, Square, Ramp, Noise, Arb (2 mHz to 50 kHz)
Phase Deviation	0° to 360°
ASK	
Carrier Waveforms	Sine, Square, Ramp, Arb (except DC)
Source	Internal/External
Modulating Waveforms	Square with 50% duty cycle (2 mHz to 1 MHz)
FSK	
Carrier Waveforms	Sine, Square, Ramp, Arb (except DC)
Source	Internal/External
Modulating Waveforms	Square with 50% duty cycle (2 mHz to 1 MHz)
PSK	
Carrier Waveforms	Sine, Square, Ramp, Arb (except DC)
Source	Internal/External
Modulating Waveforms	Square with 50% duty cycle (2 mHz to 1 MHz)
PWM	
Carrier Waveform	Pulse
Source	Internal/External
Modulating Waveforms	Sine, Square, Ramp, Noise, Arb (2 mHz to 50 kHz)
Width Deviation	0% to 100% of Pulse Width
IQ	

Carrier Waveform	Sine (max. 200 MHz)	Sine (max. 200 MHz)	Sine (max. 100 MHz)	Sine (max. 70 MHz)
Source	Internal/External			
Code Pattern	PN Sequence, 4 bits code pattern, User			
IQ Mapping	4QAM, 8QAM, 16QAM, 32QAM, 64QAM, BPSK, QPSK, OQPSK, 8PSK, 16PSK, User			
Code Rate	1 bps to 1M bps			
External Modulation Input				
Input Range	±5 Vac			
Input Bandwidth	50 kHz			
Input Impedance	10 kΩ			
Burst Characteristics				
Carrier Waveforms	Sine, Square, Ramp, Pulse, Noise, Arb (except DC)			
Carrier Frequency	1 μHz to 120 MHz	1 μHz to 120 MHz	1 μHz to 100 MHz	1 μHz to 70 MHz
Burst Count	1 to 1 000 000 or Infinite			
Start/Stop Phase	0° to 360°			
Internal Period	1 μs to 500 s			
Gated Source	External Trigger			
Trigger Source	Internal, External or Manual			
Trigger Delay	0 ns to 85 s			
Sweep Characteristics				
Carrier Waveforms	Sine, Square, Ramp, Arb (except DC)			
Type	Linear, Log or Step			
Direction	Up or Down			
Start/Stop Frequency	1 μHz to 250 MHz	1 μHz to 250 MHz	1 μHz to 100 MHz	1 μHz to 70 MHz
Sweep Time	1 ms to 300 s			
Hold/Return Time	0 ms to 300 s			

Trigger Source	Internal, External or Manual		
Marker	Falling edge of Sync signal (programmable)		
Programming Time			
Configuration Times (Typical)			
	USB2.0	LAN	GPIB
Function Change	500ms	510ms	510ms
Frequency Change	50ms	50ms	50ms
Amplitude Change	300ms	310ms	310ms
Select User Arb	500ms	510ms	510ms
Arb Download Times (Binary Transfer)			
1 Mpts/s			
Note: Download times do not include setup or output time.			
Trigger Characteristics			
Trigger Input			
Level	TTL-compatible		
Slope	Rising or falling (selectable)		
Pulse Width	> 50 ns		
Latency	Sweep: <100 ns (typical) Burst: <300 ns (typical)		
Trigger Output			
Level	TTL-compatible		
Pulse Width	> 60 ns (typical)		
Maximum Rate	1MHz		
Clock Reference			
Phase Offset			
Range	0° to 360°		
Resolution	0.001° (arb waveform), 0.03° (other waveforms)		
External Reference Input			
Lock Range	10 MHz \pm 50 Hz		
Level	80 mVpp to 10 Vpp		
Lock Time	< 2 s		
Internal Reference Output			
Frequency	10 MHz \pm 50 Hz		

Level	632 mVpp (0 dBm), nominal value
Sync Output	
Level	TTL-compatible
Impedance	50 Ω , nominal value
General Specifications	
Power	
Power Voltage	100-127 V, 45-440Hz 100-240 V, 45-65Hz
Power Consumption	Less than 125 W
Fuse	250V, T3A
Display	
Type	4.3-inch TFT LCD
Resolution	480 Horizontal \times RGB \times 272 Vertical Resolution
Color	16M color
Environment	
Temperature Range	Operating: 10 $^{\circ}$ C to 40 $^{\circ}$ C Non-Operating: -20 $^{\circ}$ C to 60 $^{\circ}$ C
Cooling Method	Cooling by fans compulsively
Humidity Range	Less than 35 $^{\circ}$ C: \leq 90% Relative Humidity (RH) 35 $^{\circ}$ C to 40 $^{\circ}$ C: \leq 60% Relative Humidity (RH)
Altitude	Operating: Less than 3000 meters Non-Operating: Less than 15000 meters
Mechanical	
Dimensions (W \times H \times D)	230 mm \times 106 mm \times 501 mm
Weight	with no package: 4.3 kg with package: 5.84 kg
Interfaces	
USB Host (2), USB Device, GPIB, LAN	
IP Protection	
IP2X	
Calibration Interval	
Recommend 1 year for standard interval	

Chapter 14 Appendix

Appendix A: Option and Accessories

	Description	Order Number
Model	DG5352 (350 MHz, dual-channel)	DG5352
	DG5351 (350 MHz, single-channel)	DG5351
	DG5252 (250 MHz, dual-channel)	DG5252
	DG5251 (250 MHz, single-channel)	DG5251
	DG5102 (100 MHz, dual-channel)	DG5102
	DG5101 (100 MHz, single-channel)	DG5101
	DG5072 (70MHz, dual-channel)	DG5072
	DG5071 (70MHz, single-channel)	DG5071
Standard Accessories	Power Cord	-
	USB Cable	CB-USB
	BNC Cable (1 meter)	CB-BNC-BNC-1
	SMB(F) to BNC(M) Cable (1 meter)	CB-SMB(F)-BNC(M)-1
	Quick Guide (Hard Copy)	-
	Resource CD (including User's Guide and Application Software)	-
Options	Frequency Hopping Module	DG5-FH
	Logic Signal Output Module	DG-POD-A
	Power Amplifier	PA1011
Optional Accessories	SMB(F) to BNC(F) Cable (1 meter)	CB-SMB(F)-BNC(F)-1
	SMB(F) to SMB(F) Cable (1 meter)	CB-SMB(F)-SMB(F)-1
	40 dB Attenuator	ATT-40dB
	Rack Mount Kit	RMK-DG-5

Appendix B: Specifications of Power Amplifier

Unless otherwise noted, all the specifications can be guaranteed if the following two conditions are met.

- The generator has been working continuously for 30 minutes at specified temperature.
- All the specifications are guaranteed unless those marked with “typical”.

Signal Input	
Input Impedance	50k Ω
Built-in Bias Voltage (Output Equivalent)	+/-12V
External Input	+/-10Vmax (Gain: X1) +/-1.25Vmax (Gain: X10)
Power Amplifier Specifications	
Running Mode	Constant Voltage
Gain	Switch between 10V/1V and 10V/10V (DC Gain Error: <5%)
Polarity Switch	Align/Invert
Effective Value of Sine Output Power (RL=7.5 Ω)	10W (Typical Value, Input Sine, 100kHz, X10)
Output Voltage	12.5Vpeak (Input Sine, 100kHz)
Output Current	1.65Apeak (Input Sine, 100kHz)
Output Impedance	<2 Ohm
Full Power Bandwidth ^[1]	DC~1MHz
Output Slew Rate ^[2]	$\geq 80\text{V}/\mu\text{s}$ (Typical)
Overshoot	<7%
Bias Voltage Specification	
Bias Voltage Gain Error	5% \pm 100mV
Others	
Power Supply	DC 12V \pm 5%, 4Apeak
Output Protection	Output Overcurrent Protection, Internal Temperature Abnormity Protection
Operating Temperature ^[3]	0 $^{\circ}\text{C}$ ~ +35 $^{\circ}\text{C}$
Dimensions (W \times H \times D)	142.2mm \times 48.1mm \times 215.4mm
Net Weight	850g \pm 20g

Note^[1]:

Full power bandwidth refers to the maximum frequency when the power amplifier can generate AC output with the maximum possible amplitude and without distortion.

$$\text{Full power bandwidth } FPB = \frac{SR}{2\pi V_{\max}}$$

SR: Slew Rate (output slew rate)

Vmax: the maximum amplitude without distortion that the amplifier can output

Note^[2]:

Definition of slew Rate: input a large step-function signal into the amplifier, the output slope of the signal is saturated to a constant at a certain position. This constant is called the Slew Rate of the amplifier.

Note^[3]:

The specifications above are all specifications under 25 °C. The range of the environment temperature for PA1011 is 0 °C ~ +35 °C and when the environment temperature is greater than 35 °C, it is recommended that users reduce the output power and the working power of PA1011.

Appendix C: Specifications of Digital Module

Unless otherwise noted, all the specifications are applicable to the digital modules of DG5000 series function/arbitrary waveform generator. All the specifications can be guaranteed if the following two conditions are met.

- The generator has been working continuously for 30 minutes at specified temperature.
- Open the system function menu and execute "Test Calibration" if the operating temperature is equal to or more than 5°C.

Common Specifications	
Digital Voltage Range	1.4~4.2V (Typical value and user-defined value) (except RS232)
Trigger Mode	Auto trigger and burst trigger
Code Pattern	ALL_0, ALL_1, 01, PRBS, User
User Space	256k Bytes in-line editing, 2M Bytes output (PC editing)
Parameters and Specifications relating to PO Protocol	
Analog Voltage Range	1.4~9.4V
Clock (CLK) Line	C0 and C1 (selectable)
Clock Phase	0°, 90°, 180°, 270° (adjustable)
Data Line	D0~D15 (selectable)
Transmission Rate	1bps~100Mbps (adjustable)
Output Data Range	1Byte~128k Bytes (selectable)
Mask Channel Setting	None, D0~D15 (selectable)
Tri-state Channel Setting	None, D0~D15 (selectable)
Parameters and Specifications relating to IIC Protocol	
Analog Voltage Range	1.4~9.4V
Bit Order	MSB
Clock (CLK) Line	D0~D15 (selectable)
Data Line	D0~D15 (selectable)
Transmission Rate	1bps~15Mbps (adjustable)
Output Data Range	1Byte~10k Bytes (selectable)
Output Address (selectable)	None or 7bits address
Operation Mode	When selecting address output, select read or write mode
Parameters and Specifications relating to SPI Protocol	

Analog Voltage Range	1.4~9.4V
Bit Order	MSB
Clock (CLK) Line	D0~D15 (selectable)
Data (SDA) Line	D0~D15 (selectable)
CS Line	D0~D15 (selectable)
Transmission Rate	1bps~60Mbps (adjustable)
Output Data Range	1Byte~40k Bytes (selectable)
Clock Polarity	0 and 1 (selectable)
Clock Phase	0 and 1 (selectable)
CS Level	Low level and high level (selectable)
Data per Frame (#Data)	1~3Bytes
Parameters and Specifications relating to RS232 Protocol	
Analog Voltage Range	2.0V~4.5V -4.5V~-2.0V
Bit Order	LSB
Data Line (TX)	D0~D15 (selectable)
Transmission Rate	1Bps~60MBps (adjustable)
Output Data Range	1Byte~35k Bytes (selectable)
Data per Frame (#Data)	5~8bits
Verify Mode	None, Fixed0, Fixed1, Odd, Even
Stop Bit	1bit, 1.5bit and 2bits

Appendix D: Warranty

RIGOL warrants that its products mainframe and accessories will be free from defects in materials and workmanship within the warranty period.

If a product is proven to be defective within the respective period, **RIGOL** guarantees the free replacement or repair of products which are approved defective. To get repair service, please contact with your nearest **RIGOL** sales or service office.

RIGOL does not provide other warranty items except the one being provided by this warranty statement. The warranty items include but not being subjected to the hint guarantee items related to tradable characteristic and any particular purpose. **RIGOL** will not take any responsibility in cases regarding to indirect, particular and ensuing damage.

Index

16PSK	5-13	End Frequency	6-2
16QAM	5-10	End Hold	6-8
32QAM	5-11	falling edge	2-7
4QAM	5-9	FH	8-1, 8-2
64QAM	5-11	FH Interval	8-4
8PSK	5-12	FH List	8-7
8QAM	5-10	FH map	8-5
Align Phase	2-12	FH Sequence	8-9
AM	4-1, 4-2	FH Switch	8-4
ASK	4-1, 4-11	Fixed4	5-5
ASK Rate	4-12	FM	4-1, 4-5
Attenuation Setting	10-7	Frequency Deviation	4-7
AutoIP	10-42	Frequency Span	6-3
BPSK	5-11	FSK	4-1, 4-14
Burst Delay	7-5	FSK Rate	4-16
Burst Period	7-4	Gated Burst	7-3
Burst Phase	7-4	GPIB Address	10-40
Carrier Phase	4-17	Hop Frequency	4-16
Center Frequency	6-1, 6-3	Host Name	10-44
Channel Copy	10-10	Infinite Burst	7-2
Channel Coupling	10-8	Internal Mode	3-4
Chess	8-5	IQ Modulation	5-1, 5-2
Cleaning	X	Linear	3-8
Code Rate	5-8	Linear Sweep	6-4
Default Gateway	10-43	Log Sweep	6-5
Delay	2-8	LSB	10-32
DHCP	10-42	ManualIP	10-42
Digital Module	10-1, 10-20, 10-27	Mark Frequency	6-7
DNS	10-43	Modulating Phase	4-19
Domain Name	10-44	Modulating Polarity ...	4-13, 4-16, 4-19
Dual Tones	3-6	Modulation Depth	4-4
Duty Cycle	2-5	MSB	10-32
Edge Time	2-8	N Cycle	7-1
Edit Block	3-9	Network Status	10-41
Edit Points	3-9	Offset	10-33

OQPSK.....	5-12	Return Time	6-7
Output Polarity.....	10-5	rising edge	2-7
Phase Deviation.....	4-10	Sinc	3-9
PictBridge	10-21	Start Frequency	6-1, 6-2
Play Mode.....	3-5	Start Hold.....	6-8
PM	4-1, 4-8	Start Point	8-5
Power Amplifier.....	10-1, 10-23	Step Sweep	6-6
PRBS.....	10-33	Subnet Mask.....	10-43
Pre-defined PN Sequence	5-5	Sweep Time.....	6-7
PSK	4-1, 4-17	symmetry	2-6
PSK Rate	4-18	Sync Polarity.....	10-5
Pulse.....	3-6	Sync Setting	10-3
PWM	4-1, 4-20	system promotion	12-1
QPSK.....	5-12	Table.....	8-5
Range Setting	10-6	threshold.....	2-7
Resistance Setting	10-6	User-defined Shortcut.....	10-20
Restore Delay.....	2-9		