

RIGOL

User's Guide

DG4000 Series

Function/Arbitrary Waveform Generator

Dec. 2015

RIGOL TECHNOLOGIES, INC.

Guaranty and Declaration

Copyright

© 2011 **RIGOL** TECHNOLOGIES, INC. All Rights Reserved.

Trademark Information

RIGOL is a registered trademark of **RIGOL** TECHNOLOGIES, INC.

Publication Number

UGB04112-1110

Software Version

00.01.12

Software upgrade might change or add product features. Please acquire the latest version of the manual from **RIGOL** website or contact **RIGOL** to upgrade the software.

Notices

- **RIGOL** products are covered by P.R.C. and foreign patents, issued and pending.
- **RIGOL** reserves the right to modify or change parts of or all the specifications and pricing policies at the company's sole decision.
- Information in this publication replaces all previously released materials.
- Information in this publication is subject to change without notice.
- **RIGOL** shall not be liable for either incidental or consequential losses in connection with the furnishing, use, or performance of this manual, as well as any information contained.
- Any part of this document is forbidden to be copied, photocopied, or rearranged without prior written approval of **RIGOL**.

Product Certification

RIGOL guarantees that this product conforms to the national and industrial standards in China as well as the ISO9001:2008 standard and the ISO14001:2004 standard. Other international standard conformance certifications are in progress.

Contact Us

If you have any problem or requirement when using our products or this manual, please contact **RIGOL**.

E-mail: service@rigol.com

Website: www.rigol.com

Safety Requirement

General Safety Summary

Please review the following safety precautions carefully before putting the instrument into operation so as to avoid any personal injury or damage to the instrument and any product connected to it. To prevent potential hazards, please follow the instructions specified in this manual to use the instrument properly.

Use Proper Power Cord.

Only the exclusive power cord designed for the instrument and authorized for use within the local country could be used.

Ground the Instrument.

The instrument is grounded through the Protective Earth lead of the power cord. To avoid electric shock, connect the earth terminal of the power cord to the Protective Earth terminal before connecting any input or output terminals.

Connect the Probe Correctly.

If a probe is used, do not connect the ground lead to high voltage since it has isobaric electric potential as the ground.

Observe All Terminal Ratings.

To avoid fire or shock hazard, observe all ratings and markers on the instrument and check your manual for more information about ratings before connecting the instrument.

Use Proper Overvoltage Protection.

Ensure that no overvoltage (such as that caused by a bolt of lightning) can reach the product. Otherwise, the operator might be exposed to the danger of an electric shock.

Do Not Operate Without Covers.

Do not operate the instrument with covers or panels removed.

Do Not Insert Anything Into the Air Outlet.

Do not insert anything into the air outlet to avoid damage to the instrument.

Use Proper Fuse.

Please use the specified fuses.

Avoid Circuit or Wire Exposure.

Do not touch exposed junctions and components when the unit is powered on.

Do Not Operate With Suspected Failures.

If you suspect that any damage may occur to the instrument, have it inspected by **RIGOL** authorized personnel before further operations. Any maintenance, adjustment or replacement especially to circuits or accessories must be performed by **RIGOL** authorized personnel.

Provide Adequate Ventilation.

Inadequate ventilation may cause an increase of temperature in the instrument, which would cause damage to the instrument. So please keep the instrument well ventilated and inspect the air outlet and the fan regularly.

Do Not Operate in Wet Conditions.

To avoid short circuit inside the instrument or electric shock, never operate the instrument in a humid environment.

Do Not Operate in an Explosive Atmosphere.

To avoid personal injuries or damage to the instrument, never operate the instrument in an explosive atmosphere.

Keep Instrument Surfaces Clean and Dry.

To avoid dust or moisture from affecting the performance of the instrument, keep the surfaces of the instrument clean and dry.

Prevent Electrostatic Impact.

Operate the instrument in an electrostatic discharge protective environment to avoid damage induced by static discharges. Always ground both the internal and external conductors of cables to release static before making connections.

Use the Battery Properly.

Do not expose the battery (if available) to high temperature or fire. Keep it out of the reach of children. Improper change of a battery (lithium battery) may cause an explosion. Use the **RIGOL** specified battery only.

Handle with Caution.

Please handle with care during transportation to avoid damage to keys, knobs, interfaces, and other parts on the panels.

Safety Notices and Symbols

Safety Notices in this Manual:

**WARNING**

Indicates a potentially hazardous situation or practice which, if not avoided, will result in serious injury or death.

**CAUTION**

Indicates a potentially hazardous situation or practice which, if not avoided, could result in damage to the product or loss of important data.

Safety Terms on the Product:

DANGER It calls attention to an operation, if not correctly performed, could result in injury or hazard immediately.

WARNING It calls attention to an operation, if not correctly performed, could result in potential injury or hazard.

CAUTION It calls attention to an operation, if not correctly performed, could result in damage to the product or other devices connected to the product.

Safety Symbols on the Product:



Hazardous
Voltage



Safety
Warning



Protective
Earth
Terminal



Chassis
Ground



Test
Ground

Allgemeine Sicherheits Informationen

Überprüfen Sie die folgenden Sicherheitshinweise sorgfältig um Personenschäden oder Schäden am Gerät und an damit verbundenen weiteren Geräten zu vermeiden. Zur Vermeidung von Gefahren, nutzen Sie bitte das Gerät nur so, wie in diesem Handbuch angegeben.

Um Feuer oder Verletzungen zu vermeiden, verwenden Sie ein ordnungsgemäßes Netzkabel.

Verwenden Sie für dieses Gerät nur das für ihr Land zugelassene und genehmigte Netzkabel.

Erden des Gerätes.

Das Gerät ist durch den Schutzleiter im Netzkabel geerdet. Um Gefahren durch elektrischen Schlag zu vermeiden, ist es unerlässlich, die Erdung durchzuführen. Erst dann dürfen weitere Ein- oder Ausgänge verbunden werden.

Anschluss eines Tastkopfes.

Die Erdungsklemmen der Sonden sind auf dem gleichen Spannungspegel des Instruments geerdet. Schließen Sie die Erdungsklemmen an keine hohe Spannung an.

Beachten Sie alle Anschlüsse.

Zur Vermeidung von Feuer oder Stromschlag, beachten Sie alle Bemerkungen und Markierungen auf dem Instrument. Befolgen Sie die Bedienungsanleitung für weitere Informationen, bevor Sie weitere Anschlüsse an das Instrument legen.

Verwenden Sie einen geeigneten Überspannungsschutz.

Stellen Sie sicher, daß keinerlei Überspannung (wie z.B. durch Gewitter verursacht) das Gerät erreichen kann. Andernfalls besteht für den Anwender die Gefahr eines Stromschlages.

Nicht ohne Abdeckung einschalten.

Betreiben Sie das Gerät nicht mit entfernten Gehäuse-Abdeckungen.

Betreiben Sie das Gerät nicht geöffnet.

Der Betrieb mit offenen oder entfernten Gehäuseteilen ist nicht zulässig. Nichts in entsprechende Öffnungen stecken (Lüfter z.B.)

Passende Sicherung verwenden.

Setzen Sie nur die spezifikationsgemäßen Sicherungen ein.

Vermeiden Sie ungeschützte Verbindungen.

Berühren Sie keine unisolierten Verbindungen oder Baugruppen, während das Gerät in Betrieb ist.

Betreiben Sie das Gerät nicht im Fehlerfall.

Wenn Sie am Gerät einen Defekt vermuten, sorgen Sie dafür, bevor Sie das Gerät wieder betreiben, dass eine Untersuchung durch **RIGOL** autorisiertem Personal durchgeführt wird. Jedwede Wartung, Einstellarbeiten oder Austausch von Teilen am Gerät, sowie am Zubehör dürfen nur von **RIGOL** autorisiertem Personal durchgeführt werden.

Belüftung sicherstellen.

Unzureichende Belüftung kann zu Temperaturanstiegen und somit zu thermischen Schäden am Gerät führen. Stellen Sie deswegen die Belüftung sicher und kontrollieren regelmäßig Lüfter und Belüftungsöffnungen.

Nicht in feuchter Umgebung betreiben.

Zur Vermeidung von Kurzschluß im Geräteinneren und Stromschlag betreiben Sie das Gerät bitte niemals in feuchter Umgebung.

Nicht in explosiver Atmosphäre betreiben.

Zur Vermeidung von Personen- und Sachschäden ist es unumgänglich, das Gerät ausschließlich fernab jedweder explosiven Atmosphäre zu betreiben.

Geräteoberflächen sauber und trocken halten.

Um den Einfluß von Staub und Feuchtigkeit aus der Luft auszuschließen, halten Sie bitte die Geräteoberflächen sauber und trocken.

Schutz gegen elektrostatische Entladung (ESD).

Sorgen Sie für eine elektrostatisch geschützte Umgebung, um somit Schäden und

Funktionsstörungen durch ESD zu vermeiden. Erden Sie vor dem Anschluß immer Innen- und Außenleiter der Verbindungsleitung, um statische Aufladung zu entladen.

Die richtige Verwendung des Akku.

Wenn eine Batterie verwendet wird, vermeiden Sie hohe Temperaturen bzw. Feuer ausgesetzt werden. Bewahren Sie es außerhalb der Reichweite von Kindern auf. Unsachgemäße Änderung der Batterie (Anmerkung: Lithium-Batterie) kann zu einer Explosion führen. Verwenden Sie nur von **RIGOL** angegebenen Akkus.

Sicherer Transport.

Transportieren Sie das Gerät sorgfältig (Verpackung!), um Schäden an Bedienelementen, Anschlüssen und anderen Teilen zu vermeiden.

Sicherheits Begriffe und Symbole

Begriffe in diesem Guide:



WARNING

Die Kennzeichnung WARNING beschreibt Gefahrenquellen die leibliche Schäden oder den Tod von Personen zur Folge haben können.



CAUTION

Die Kennzeichnung Caution (Vorsicht) beschreibt Gefahrenquellen die Schäden am Gerät hervorrufen können.

Begriffe auf dem Produkt:

DANGER weist auf eine Verletzung oder Gefährdung hin, die sofort geschehen kann.

WARNING weist auf eine Verletzung oder Gefährdung hin, die möglicherweise nicht sofort geschehen.

CAUTION weist auf eine Verletzung oder Gefährdung hin und bedeutet, dass eine mögliche Beschädigung des Instruments oder anderer Gegenstände auftreten kann.

Symbole auf dem Produkt:



Gefährliche
Spannung



Sicherheits-
Hinweis



Schutz-erde



Gehäusemasse



Erde

Care and Cleaning

Care

Do not store or leave the instrument where it may be exposed to direct sunlight for long periods of time.

Cleaning

Clean the instrument regularly according to its operating conditions.

1. Disconnect the instrument from all power sources.
2. Clean the external surfaces of the instrument with a soft cloth dampened with mild detergent or water. When cleaning the LCD, take care to avoid scarifying it.



CAUTION

To avoid damage to the instrument, do not expose it to caustic liquids.



WARNING

To avoid short-circuit resulting from moisture or personal injuries, ensure that the instrument is completely dry before connecting it to the power supply.

Environmental Considerations

The following symbol indicates that this product complies with the WEEE Directive 2002/96/EC.



Product End-of-Life Handling

The equipment may contain substances that could be harmful to the environment or human health. To avoid the release of such substances into the environment and avoid harm to human health, we recommend you to recycle this product appropriately to ensure that most materials are reused or recycled properly. Please contact your local authorities for disposal or recycling information.

DG4000 Series Overview

DG4000 is a dual-channel economical, high-performance and multifunctional generator that combines many functions in one, including function generator, arbitrary waveform generator, pulse generator, harmonics generator, analog/digital modulator and counter. All the models of DG4000 provide two channels with equivalent functions and adjustable phase between the two channels.

Main Features:

- Adopt the Direct Digital Synthesizer (DDS) technology and provide stable, precise, pure and low distortion signals.
- 7 inches, 16M true color TFT LCD, displaying parameters and graphics of the two channels at the same time.
- 200MHz, 160MHz, 100MHz or 60MHz maximum output frequency (for Sine), 500MSa/s sample rate, 14bits vertical resolution.
- Precisely adjust the phases of the two channels.
- Support external power amplifier module (option) with on-line configuration function.
- 150 waveforms or functions: Sine, Square, Ramp, Pulse, Noise, Sinc, Exponential Rise, Exponential Fall, ECG, Gauss, Haversine, Lorentz, Dual Tones, Harmonics, Video Signal, Radar Signal, DC etc.
- Enable to edit 16kpts arbitrary waveform and support point by point output of arbitrary waveform.
- Rise Time and Fall Time of the Pulse could be adjusted separately.
- Enable to output harmonic with specified order and amplitude, enable to output up to 16th order of harmonic.
- Support to superpose Gauss Noise onto basic waveforms.
- Various modulation types: AM, FM, PM, ASK, FSK, PSK, BPSK, QPSK, 3FSK, 4FSK, OSK and PWM modulations.
- Support frequency sweep and Burst output.
- Dual channels can perform internal/external modulation and internal/external/manual trigger separately or at the same time.
- Dual channels can output sync signal separately or at the same time.
- Support to enable Frequency Coupling, Phase Coupling and Amplitude Coupling separately or at the same time.
- Provide 7digits/s, 200MHz counter; enable to measure various parameters of external signal such as frequency, period, duty cycle, positive pulse width and negative pulse width; provide statistic function of measurement results.

- Support waveform copy and state copy between channels.
- Enable to store and recall arbitrary waveform data files and instrument state files; support various file types.
- Plenty of standard interfaces: USB Host, USB Device and LAN.
- Abundant I/O: waveform output, sync signal output, modulation input, 10MHz clock input/output and trigger input/output.
- Support FAT32 formatted USB storage device (flash type) storage.
- Support 10/100M Ethernet web; users can control the instrument remotely via web.
- Conform to LXI Core 2011 Device instrument standards.
- Provide Chinese and English help information, prompt messages and interface display.
- Provide powerful waveform editing PC software (Ultra Station).
- Provide security lock hole.

Document Overview

Subjects in this Manual:

Chapter 1 Quick Start

This chapter introduces the front panel, rear panel, user interface and parameter setting method as well as the precautions when using the instrument for the first time.

Chapter 2 Basic Waveform Output

This chapter introduces how to output basic waveforms, e.g. Sine and Square.

Chapter 3 Arbitrary Waveform Output

This chapter introduces how to output built-in or user-defined waveforms.

Chapter 4 Harmonics Output

This chapter introduces how to output harmonics with specified order.

Chapter 5 Modulated Waveform Output

This chapter introduces how to output modulated waveforms, e.g. AM, FSK and PWM.

Chapter 6 Sweep

This chapter introduces how to generate a frequency Sweep.

Chapter 7 Burst

This chapter introduces how to generate a Burst waveform.

Chapter 8 Counter

This chapter introduces how to use the counter.

Chapter 9 Store and Recall

This chapter introduces how to store and recall the waveform data or the instrument state settings.

Chapter 10 Utility and System Settings

This chapter introduces the utility functions and system settings.

Chapter 11 Remote Control

This chapter introduces how to control the instrument remotely.

Chapter 12 Troubleshooting

This chapter lists commonly encountered failures that may appear during the use of the generator and their solutions.

Chapter 13 Specifications

This chapter lists the performances and general specifications of the instrument.

Chapter 14 Appendix

This chapter provides the information about the options and accessories, as well as other points for attention.

Format Conventions in this Manual:

1. Key:

The key at the front panel is denoted by the format of "Text Box + Key Name (Bold)" in the manual, for example, **Sine**.

2. Menu:

The menu is denoted by the format of "Character Shading + Menu Word (Bold)" in the manual, for example, **Freq**.

3. Connector:

The connector at the front or rear panel is denoted by the format of "Square Brackets + Connector Name (Bold)" in the manual, for example, **[Sync]**.

4. Operation Step:

The next step of the operation is denoted by an arrow "→" in the manual. For example, **Sine** → **Freq** denotes pressing **Sine** at the front panel and then pressing **Freq**.

Content Conventions in this Manual:

DG4000 series function/arbitrary waveform generator includes the following models. In this manual, DG4162 is taken as an example to illustrate DG4000 series function/arbitrary waveform generator. The introductions cover all the functions and performance of the other models.

Model	Number of Channels	Max. Output Frequency	Sample Rate
DG4062	2	60MHz	500MSa/s
DG4102	2	100MHz	500MSa/s
DG4162	2	160MHz	500MSa/s
DG4202	2	200MHz	500MSa/s

Contents

Guaranty and Declaration	I
Safety Requirement	II
General Safety Summary	II
Safety Terms and Symbols	V
Allgemeine Sicherheits Informationen	VI
Sicherheits Begriffe und Symbole.....	IX
Care and Cleaning	X
Environmental Considerations	XI
DG4000 Series Overview	XIII
Document Overview	XV
Chapter 1 Quick Start	1-1
General Inspection	1-2
To Adjust the Supporting Legs.....	1-3
Appearance and Dimensions	1-4
Front Panel	1-6
Rear Panel.....	1-13
To Connect to Power	1-16
To Replace the Fuse	1-17
User Interface	1-18
Parameter Setting Method.....	1-21
Numeric Keyboard	1-21
Direction keys and Knob.....	1-22
To Use the Built-In Help.....	1-23
To Use the Security Lock.....	1-24
Chapter 2 Basic Waveform Output	2-1
To Select the Channel.....	2-2
To Select Basic Waveform	2-3
To Set the Frequency.....	2-4
To Set the Amplitude	2-5
To Set the DC Offset Voltage	2-8
To Set the Start Phase	2-9

Align Phase.....	2-10
To Set the Duty Cycle	2-12
To Set the Symmetry	2-13
To Set the Pulse Parameters.....	2-14
Pulse Width/Duty Cycle	2-14
Leading/Trailing Edge Time	2-15
To Enable the Channel Output.....	2-16
Basic Waveform Output Example	2-17
Chapter 3 Arbitrary Waveform Output.....	3-1
To Enable Arbitrary Waveform	3-2
Point By Point Output Mode	3-4
To Select Arbitrary Waveform	3-5
Built-In Waveform.....	3-5
Stored Waveform.....	3-10
Volatile Waveform.....	3-10
To Create an Arbitrary Waveform.....	3-11
Example: Edit Points	3-14
Example: Edit Block	3-16
To Edit Arbitrary Waveform	3-18
Chapter 4 Harmonic Output	4-1
Overview	4-2
To Set the Fundamental Waveform Parameters.....	4-2
To Set the Harmonic Order.....	4-3
To Select the Harmonic Type	4-3
To Set the Harmonic Amplitude	4-4
To Set the Harmonic Phase	4-5
Chapter 5 Modulated Waveform Output	5-1
AM	5-2
To Select AM Modulation	5-2
To Select Carrier Waveform Shape	5-2
To Set Carrier Frequency.....	5-2
To Select Modulating Waveform Source	5-3
To Set Modulating Waveform Frequency	5-4
To Set Modulation Depth	5-4
Double Sideband Suppressed Carrier.....	5-5
FM	5-6

To Select FM Modulation	5-6
To Select the Carrier Waveform Shape.....	5-6
To Set the Carrier Frequency	5-6
To Select the Modulating Waveform Source	5-7
To Set the Modulating Waveform Frequency	5-8
To Set the Frequency Deviation	5-8
PM	5-9
To Select PM Modulation	5-9
To Select the Carrier Waveform Shape.....	5-9
To Set the Carrier Frequency	5-9
To Select the Modulating Waveform Source	5-10
To Set the Modulating Waveform Frequency	5-11
To Set the Phase Deviation.....	5-11
ASK.....	5-12
To Select ASK Modulation	5-12
To Select the Carrier Waveform Shape.....	5-12
To Set the Carrier Amplitude.....	5-12
To Select the Modulating Waveform Source	5-13
To Set the ASK Rate.....	5-13
To Set the Modulating Amplitude	5-14
To Set the Modulating Polarity	5-14
FSK	5-15
To Select FSK Modulation	5-15
To Select the Carrier Waveform Shape.....	5-15
To Set the Carrier Frequency	5-15
To Select the Modulating Waveform Source	5-16
To Set the FSK Rate	5-17
To Set the Hop Frequency	5-17
To Set the Modulating Polarity	5-17
PSK	5-18
To Select PSK Modulation	5-18
To Select the Carrier Waveform Shape.....	5-18
To Set the Carrier Phase.....	5-18
To Select the Modulating Waveform Source	5-19
To Set the PSK Rate.....	5-19
To Set the PSK Phase.....	5-20
To Set the Modulating Polarity	5-20

BPSK	5-21
To Select BPSK Modulation	5-21
To Select the Carrier Waveform Shape.....	5-21
To Set the Carrier Phase.....	5-21
To Select the Modulating Waveform Source	5-22
To Set the BPSK Rate	5-22
To Set the BPSK Phase	5-23
QPSK.....	5-24
To Select QPSK Modulation	5-24
To Select the Carrier Waveform Shape.....	5-24
To Set the Carrier Phase.....	5-24
To Select the Modulating Waveform Source	5-25
To Set the QPSK Rate.....	5-25
To Set the QPSK Phases	5-25
3FSK	5-26
To Select 3FSK Modulation.....	5-26
To Select the Carrier Waveform Shape.....	5-26
To Set the Carrier Frequency	5-26
Modulation Source	5-27
To Set the 3FSK Rate	5-27
To Set the Hop Frequencies	5-27
4FSK	5-28
To Select 4FSK Modulation.....	5-28
To Select the Carrier Waveform Shape.....	5-28
To Set the Carrier Frequency	5-28
Modulation Source	5-29
To Set the 4FSK Rate	5-29
To Set the Hop Frequencies	5-29
OSK	5-30
To Select OSK Modulation.....	5-30
To Select the Carrier Waveform Shape.....	5-31
To Set the Carrier Frequency	5-31
To Select the Modulating Waveform Source	5-31
To Set the OSK Rate	5-32
To Set the Oscillate Period.....	5-32
PWM	5-33
To Select PWM Modulation	5-33

To Select the Carrier Waveform Shape.....	5-33
To Set the Pulse Width/Duty Cycle	5-33
To Select the Modulating Waveform Source	5-34
To Set the Modulating Waveform Frequency	5-34
To Set the Pulse Width/Duty Cycle Deviation.....	5-35
Chapter 6 Sweep	6-1
To Enable Frequency Sweep	6-2
Start Frequency and End Frequency	6-2
Center Frequency and Frequency Span	6-3
Sweep Type	6-4
Linear Sweep	6-4
Log Sweep	6-5
Step Sweep	6-6
Sweep Time.....	6-7
Return Time.....	6-8
Mark Frequency	6-8
Start Hold	6-9
End Hold	6-9
Sweep Trigger Source.....	6-10
Trigger Output Edge	6-11
Chapter 7 Burst.....	7-1
To Enable Burst Mode.....	7-2
Burst Type	7-2
N Cycle Burst	7-2
Infinite Burst	7-3
Gated Burst.....	7-4
Burst Phase	7-6
Burst Period.....	7-6
Gated Polarity	7-6
Burst Delay.....	7-7
Burst Trigger Source.....	7-7
Trigger Output Edge	7-8
Chapter 8 Counter	8-1
To Enable the Counter	8-2
To Set the Counter	8-3
Statistic	8-6

Chapter 9 Store and Recall	9-1
Storage System Overview	9-2
File Type	9-4
Browser Type	9-5
File Operation	9-6
Save	9-6
Read	9-8
Copy and Paste	9-9
Delete	9-9
New Directory	9-10
Seamless Interconnection with Oscilloscope	9-11
Chapter 10 Utility Functions and System Settings	10-1
Overview	10-2
Channel Setting	10-3
Sync	10-3
Sync Polarity	10-4
Sync Mode	10-5
Output Polarity	10-5
Impedance	10-6
Noise Superimposition	10-7
Range	10-7
DDS Hold	10-7
To Set the System Language	10-8
To Configure the Remote Interface	10-9
LAN Setting	10-9
To Set the USB Device Type	10-14
System Setting	10-15
Number Format	10-15
Power On Setting	10-16
Power Setting	10-16
Clock Source	10-16
Brightness	10-17
Beeper	10-18
Screen Saver	10-18
System Information	10-18
Print	10-19
Test/Cal	10-21

Channel Coupling	10-22
Channel Copy.....	10-25
User-defined Waveform Key	10-26
To Restore the Preset Configuration.....	10-28
To Use the External Power Amplifier (Option)	10-33
To Lock the Keys	10-37
Chapter 11 Remote Control	11-1
Remote Control via USB.....	11-2
Remote Control via LAN	11-6
Chapter 12 Troubleshooting	12-1
Chapter 13 Specifications.....	13-1
Chapter 14 Appendix	14-1
Appendix A: Options and Accessories.....	14-1
Appendix B: Power Amplifier Specifications	14-2
Appendix C: Warranty.....	14-4
Index	1

Chapter 1 Quick Start

This chapter introduces the front panel, rear panel, user interface and parameter setting method as well as precautions when using the instrument for the first time.

Subjects in this chapter:

- General Inspection
- To Adjust the Supporting Legs
- Appearance and Dimensions
- Front Panel
- Rear Panel
- To Connect to Power
- To Replace the Fuse
- User Interface
- Parameter Setting Method
- To Use the Built-In Help
- To Use the Security Lock

General Inspection

1. Inspect the packaging

If the packaging has been damaged, do not dispose the damaged packaging or cushioning materials until the shipment has been checked for completeness and has passed both electrical and mechanical tests.

The consigner or carrier shall be liable for the damage to the instrument resulting from shipment. **RIGOL** would not be responsible for free maintenance/rework or replacement of the instrument.

2. Inspect the instrument

In case of any mechanical damage, missing parts, or failure in passing the electrical and mechanical tests, contact your **RIGOL** sales representative.

3. Check the accessories

Please check the accessories according to the packing lists. If the accessories are damaged or incomplete, please contact your **RIGOL** sales representative.

To Adjust the Supporting Legs

DG4000 allows users to unfold the supporting legs as stands to tilt the generator upwards for easier operation and observation during operation (as shown in Figure 1-1). Users can fold the supporting legs for easier storage or carry when the instrument is not in use (as shown in Figure 1-2).

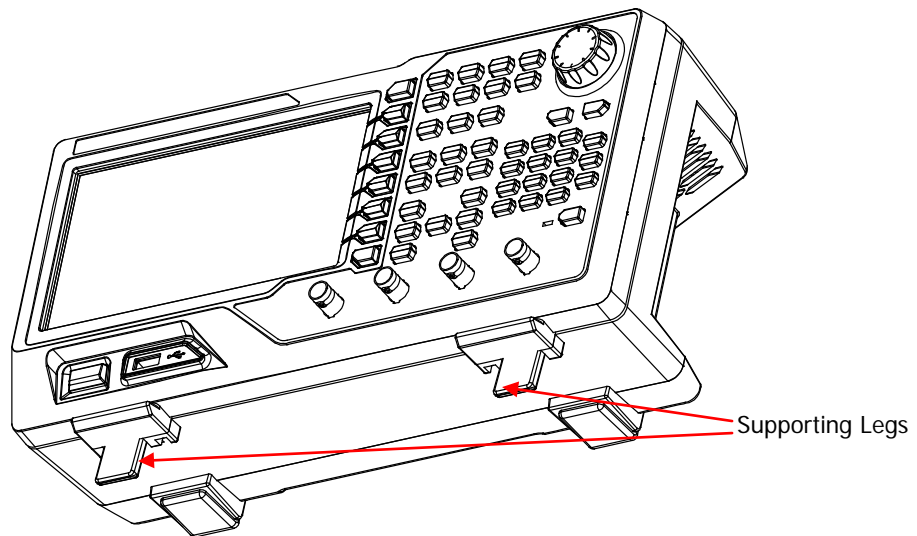

Figure 1-1 Unfold the Supporting Legs

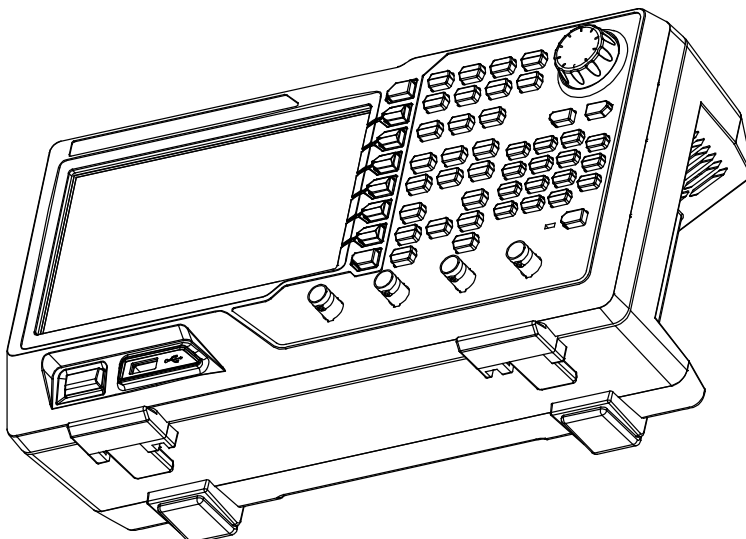

Figure 1-2 Fold the Supporting Legs

Appearance and Dimensions

The appearance and dimensions of DG4000 are as shown in Figure 1-3 and Figure 1-4 and the unit is mm.

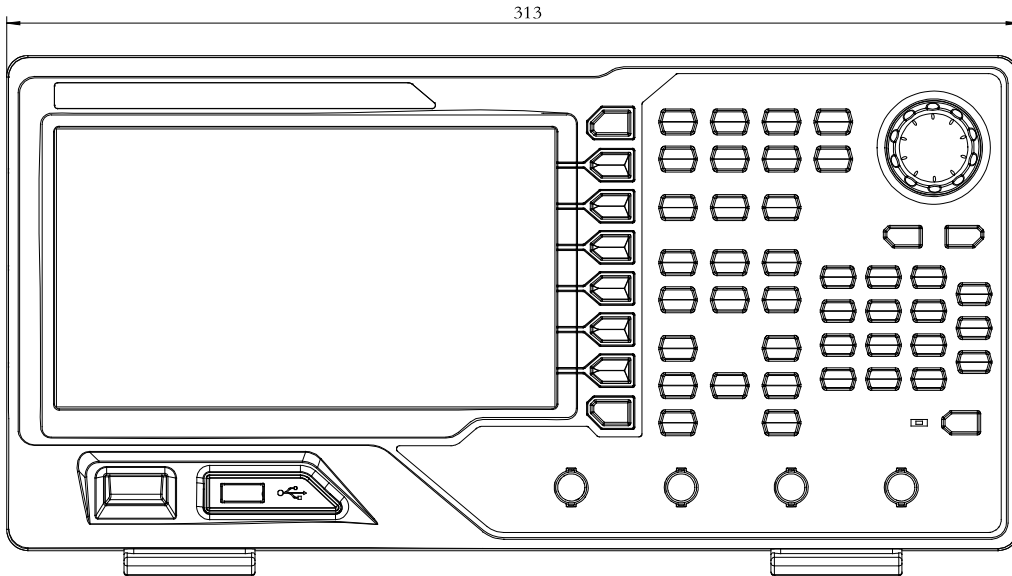

Figure 1-3 Front View

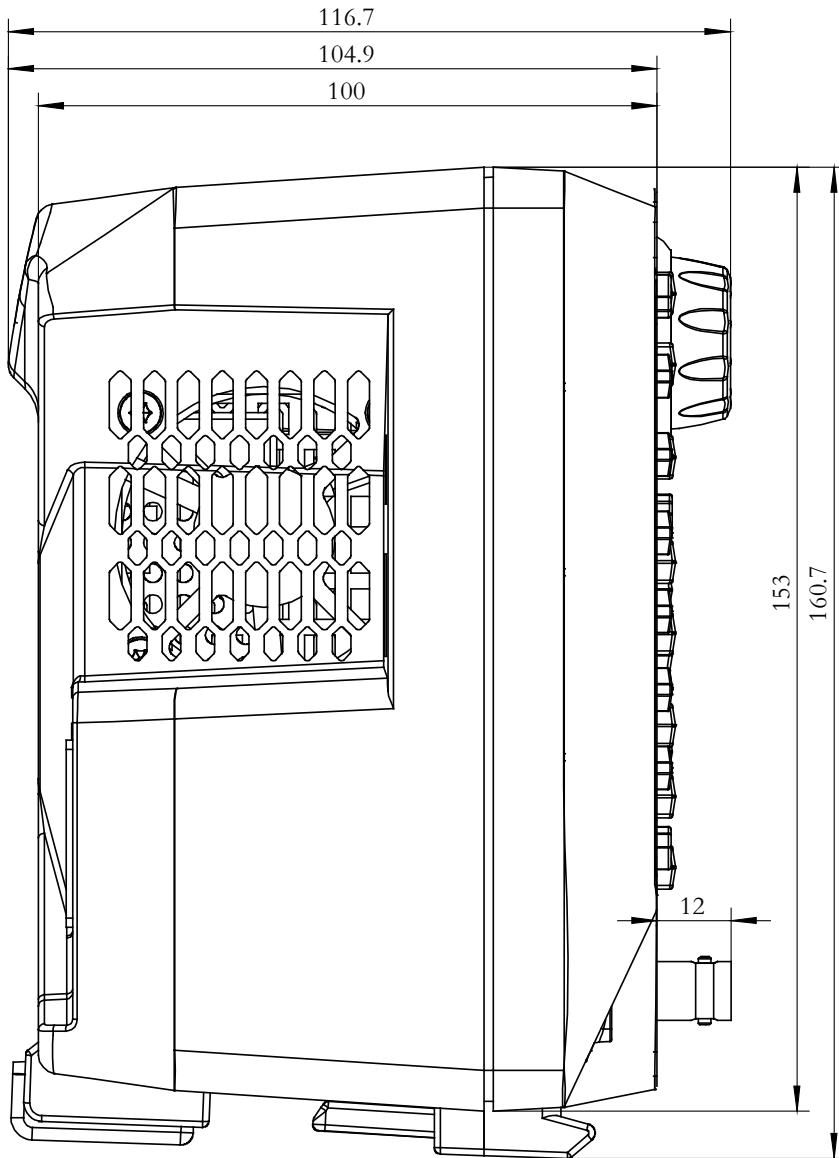

Figure 1-4 Side View

Front Panel

The front panel of DG4000 is shown below.

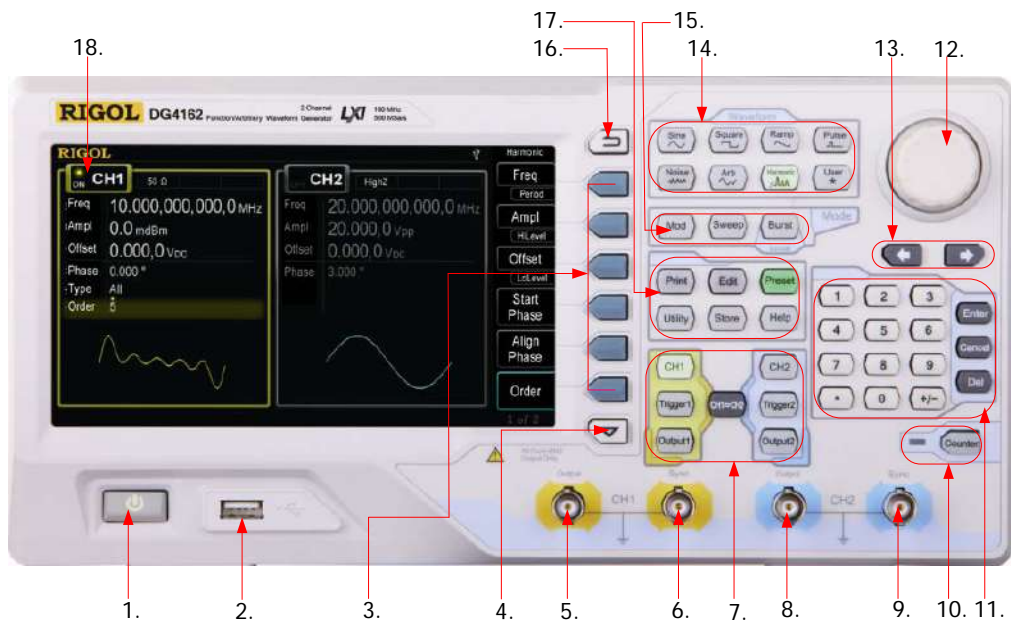

Figure 1-5 DG4000 Front Panel

1. Power Key

The power key is used to turn the generator on or off. When the power key is turned off, the generator is in standby mode; the generator is in power-off mode only when the power cable at the rear panel is pulled out.

Users can enable or disable the function of this key. When enabled, users need to press this key to start the instrument after power-on; when disabled, the instrument starts automatically after power-on.

2. USB Host

Support USB storage device, **RIGOL** digital oscilloscope and power amplifier.

- USB Storage Device: read the waveform files or state files in the USB storage device; store the current instrument state or edited arbitrary waveform data into the USB storage device; store the content currently displayed on the screen in the specified picture format (.Bmp or .Jpeg) in

the USB storage device (a new folder named "Rigol" is created in the USB storage device automatically).

- Digital Oscilloscope: seamlessly interconnect with **RIGOL** DS1000E, DS6000, MSO/DS4000, MSO/DS2000 and MSO/DS1000Z series digital oscilloscopes; read and store the waveform displayed on the screen or stored in the internal memory of the oscilloscope and then rebuild the waveform losslessly.
- Power Amplifier (Option): support **RIGOL** power amplifier (for example, PA1011); users can perform on-line configuration of the power amplifier as well as amplify the power of the signal and then output the signal.

3. Menu Softkey

Correspond to the left menus respectively. Press any softkey to activate the corresponding menu.

4. Page Up/Down

Open the previous or next page of the current function menu.

5. CH1 Output

BNC connector with 50Ω nominal output impedance.

When **Output1** is enabled (the backlight turns on), this connector output waveform according to the current configuration of CH1.

6. CH1 Sync Output

BNC connector with 50Ω nominal output impedance.

When the sync output of CH1 is enabled, this connector outputs the sync signal corresponding to the current settings of CH1 (refer to the introduction in **Sync**).

7. Channel Control Area

CH1: used to select CH1. When CH1 is selected (the backlight turns on), users can set the waveform and parameters of CH1.

CH2: used to select CH2. When CH2 is selected (the backlight turns on), users can set the waveform and parameters of CH2.

Trigger1: in sweep or burst mode, it is used to trigger CH1 to generate a

sweep or burst output manually (only when **Output1** is enabled).

Trigger2: in sweep or burst mode, it is used to trigger CH2 to generate a sweep or burst output manually (only when **Output2** is enabled).

Output1: enable or disable the output of CH1.

Output2: enable or disable the output of CH2.

CH1=CH2: execute channel copy (refer to the introductions in "Channel Copy").

8. CH2 Output

BNC connector with 50Ω nominal output impedance.

When **Output2** is enabled (the backlight turns on), this connector outputs waveform according to the current configuration of CH2.

9. CH2 Sync Output

BNC connector with 50Ω nominal output impedance.

When the sync output of CH2 is enabled, this connector outputs the sync signal corresponding to the current settings of CH2 (refer to the introduction in "Sync").

10. Counter

Press **Counter** to turn the counter on or off. When the counter is turned on, the backlight of the key is illuminated and the left indicator flickers. If the counter interface is currently displayed, press this key again to disable counter function; if the screen currently displays interfaces other than the counter interface, press this key again to switch to counter interface (refer to the introductions in **Counter**).

11. Numeric Keyboard

It is used to input parameters and consists of numbers (0 to 9), decimal point (.), operators (+/-) and buttons ("Enter", "Cancel" and "Del"). Note that if a negative is required, please input an operator "-" before the numbers. In addition, the decimal point "." can be used to switch units quickly and the operators "+/-" can be used to switch between uppercase and lowercase (for

the use method of the numeric keyboard, refer to the introduction in "**Parameter Setting Method**").

12. Knob

During parameter setting, it is used to increase (clockwise) or decrease (counterclockwise) the current highlighted number.

It is used to select file storage location or select the file to be recalled when storing or recalling file.

It is used to switch the character in the soft keyboard when entering filename.

It is used to select built-in waveform when defining the shortcut waveform of **User**.

13. Direction Keys

When using the knob and direction keys to set parameters, the direction keys are used to switch the digits of the number.

During filename input, they are used to move the cursor.

14. Waveform Selection Area

Sine----Sine

Generate a sine waveform with frequency from 1 μ Hz to 160MHz.

- When this function is selected, the backlight of the key turns on.
- You can modify the "Freq/Period", "Ampl/HiLevel", "Offset/LoLevel" and "Start Phase" of the sine waveform.

Square----Square

Generate a square waveform with frequency from 1 μ Hz to 50MHz and variable duty cycle.

- When this function is selected, the backlight of the key turns on.
- You can modify the "Freq/Period", "Ampl/HiLevel", "Offset/LoLevel", "Duty Cycle" and "Start Phase" of the square waveform.

Ramp----Ramp

Generate a ramp waveform with frequency from 1 μ Hz to 4MHz and variable symmetry.

- When this function is selected, the backlight of the key turns on.
- You can modify the "Freq/Period", "Ampl/HiLevel", "Offset/LoLevel", "Symmetry" and "Start Phase" of the ramp waveform.

Pulse----**Pulse**

Generate a pulse waveform with frequency from 1 μ Hz to 40MHz and variable pulse width and edge time.

- When this function is selected, the backlight of the key turns on.
- You can modify the "Freq/Period", "Ampl/HiLevel", "Offset/LoLevel", "Width/Duty", "Leading", "Trailing" and "Start Phase" of the pulse waveform.

Noise----**Noise**

Generate a Gauss noise with 120MHz bandwidth.

- When this function is selected, the backlight of the key turns on.
- You can modify the "Ampl/HiLevel" and "Offset/LoLevel" of the noise.

Arb----**Arbitrary Waveforms**

Generate an arbitrary waveform with frequency from 1 μ Hz to 40MHz.

- The instrument supports point by point output mode.
- The instrument can output the 150 kinds of built-in waveforms and the arbitrary waveforms stored in USB storage device.
- The instrument can also output the arbitrary waveforms (16 kpts) edited from the front panel or through the PC software and then downloaded to the instrument by the users.
- When this function is selected, the backlight of the key turns on.
- You can modify the "Freq/Period", "Ampl/HiLevel", "Offset/LoLevel" and "Start Phase" of the arbitrary waveform.

Harmonic----**Harmonic**

Generate harmonics with frequency from 1 μ Hz to 80MHz.

- The instrument can output up to 16th order of harmonic.
- Users can set the harmonic "Order", "Type", "Ampl" and "Phase".

User----**User-defined Waveform Key**

Users can define the frequently used built-in waveform or stored waveform as shortcut (**Utility** → **UserKey**). And then, in any operation interface, press

User to quickly open the desired waveform and set its parameters.

15. Modes

Mod----Modulation

Generate the modulated waveforms. Provide various analog modulation and digital modulation modes and can generate AM, FM, PM, ASK, FSK, PSK, BPSK, QPSK, 3FSK, 4FSK, OSK or PWM modulated signal.

- Support internal and external modulations.

Sweep----Sweep

Generate the frequency sweeping signal of Sine, Square, Ramp and Arbitrary Waveforms (except DC).

- Support three sweep types: Linear, Log and Step.
- Support three trigger sources: Internal, External and Manual.
- Provide the "Mark" function.
- When the function is enabled, the backlight of the button turns on.

Burst----Burst

Generate burst waveforms of Sine, Square, Ramp, Pulse and Arbitrary waveform (except DC).

- Support three burst types: N Cycle, Infinite and Gated.
- Noise can also be used to generate Gated burst.
- Support three trigger sources: Internal, External and Manual.
- When the function is enabled, the backlight of the button turns on.

Note: When the instrument is working in remote mode, you can return it back to local mode by pressing **Burst**.

16. Return

This key is used to return to the previous menu.

17. Shortcuts/Utility

Print----Print

It is used to execute the print function to save the content displayed on the screen as image in USB storage device.

Edit----Waveform Edit Shortcut Key

This key is the shortcut of "**Arb** → **Edit Wform**" and is used to quickly open the arbitrary waveform editing interface.

Preset----Restore the Preset Values

It is used to restore the instrument state to the factory default values or user-defined states (refer to the introduction in "To Restore the Preset Configuration").

Utility----Utility Functions and System Settings

It is used to set the utility function parameters and the system parameters. When this function is selected, the backlight of the key turns on.

Store----Storage

Users can store or recall the instrument state or user-edited arbitrary waveform data.

- Support normal file operations.
- Provide a built-in non-volatile memory (C Disk) and can connect an external USB storage device (D Disk).
- When this function is selected, the backlight of the key turns on.

Help----Help

To get the context help information about any front-panel key or menu softkey, press this key until it is illuminated and then press the desired key.

18. LCD

800 × 480 TFT color LCD is used to display the current function menu and parameters setting, system state as well as prompt messages.

**CAUTION**

Overvoltage protection of the output channel will take effect once any of the following conditions is met.

- Amplitude setting in the generator is greater than 4Vpp; the input voltage is greater than $\pm 11.25\text{V}$ ($\pm 0.1\text{V}$) and frequency is lower than 10kHz.
- Amplitude setting in the generator is lower than or equal to 4Vpp; the input voltage is greater than $\pm 4.5\text{V}$ ($\pm 0.1\text{V}$) and frequency is lower than 10kHz.
- The message "OverLoad protect, The output is off!" will appear on the screen when overvoltage protection takes effect.

Rear Panel

The rear panel of DG4000 is as shown in the figure below.



Figure 1-6 DG4000 Rear Panel

1. AC Power Input

This generator can accept AC power supply of 100-240V, 45-440Hz.
Power Fuse: 250V, T2 A.

2. LAN

Connect the generator to the local area network for remote control through this interface. This generator conforms to LXI Core 2011 Device instrument standards and can quickly build test system with other devices to easily realize system integration.

3. Security Lock Hole

Users can use the security lock (buy it by themselves) to lock the instrument at a fixed location.

4. USB Device

PictBridge printer or PC can be connected through this interface to print the screen image or control the generator remotely through PC software.

5. 10MHz In/Out

BNC female connector with 50Ω nominal impedance. The function of this connector is determined by the type of clock used by the generator. DG4000 can use internal or external clock (refer to the introduction in "**Clock Source**").

- When internal clock source is used, the connector (used as 10MHz Out) can output 10MHz clock signal generated by the internal crystal oscillator of the generator.
- When external clock source is used, the connector (used as 10MHz In) accepts a 10MHz external clock signal.
- This connector is usually used to synchronize multiple instruments (refer to the introduction in "**Sync**").

6. CH1: Mod/FSK/Trig

BNC female connector with 50Ω nominal impedance. Its function is determined by the current working mode of CH1.

- **Mod:**
If AM, FM, PM, PWM or OSK is enabled for CH1 and external modulation source is used, this connector accepts an external modulation signal.
- **FSK:**
If ASK, FSK or PSK is enabled for CH1 and external modulation source is used, this connector accepts an external modulation signal (users can set the polarity of the signal).
- **Trig In:**
If CH1 is in sweep or burst mode and external trigger source is used, this connector accepts an external trigger signal (users can set the polarity of the signal).
- **Trig Out:**
If CH1 is in sweep or burst mode and internal or manual trigger source is used, this connector outputs a trigger signal with specified edge.

7. CH2: Mod/FSK/Trig

BNC female connector with 50Ω nominal impedance. Its function is

determined by the current working mode of CH2.

- **Mod:**
If AM, FM, PM, PWM or OSK is enabled for CH2 and external modulation source is used, this connector accepts an external modulation signal.
- **FSK:**
If ASK, FSK or PSK is enabled for CH2 and external modulation source is used, this connector accepts an external modulation signal (users can set the polarity of the signal).
- **Trig In:**
If CH2 is in sweep or burst mode and external trigger source is used, this connector accepts an external trigger signal (users can set the polarity of the signal).
- **Trig Out:**
If CH2 is in sweep or burst mode and internal or manual trigger source is used, this connector outputs a trigger signal with specified edge.

8. External Signal Input (Counter)

BNC female connector with 50Ω nominal impedance. It is used to accept an external signal to be measured by the counter.

To Connect to Power

DG4000 accepts AC power supply: 100 to 240V, 45Hz to 440Hz. Please use the power cable provided in the accessories to connect the instrument to AC power (as shown in Figure 1-7). At this point, the generator is powered on and the power button at the lower-left corner of the front panel is in breathing state.

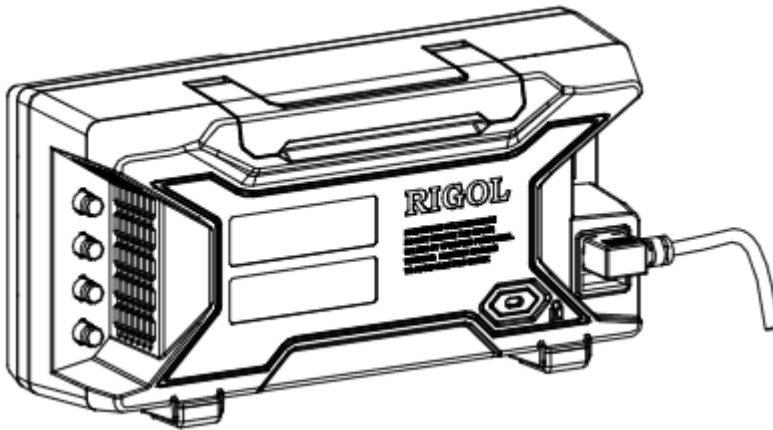

Figure 1-7 To Connect to Power



CAUTION

If the power fuse needs to be changed, please return the instrument back to our factory and the **RIGOL** authorized operator will change it for you.

To Replace the Fuse

To replace the fuse, please use the specified fuse and follow the steps below.

1. Turn off the instrument, cut off the power supply and remove the power cord.
2. Use a small straight screwdriver to prize out the fuse seat.
3. Take out the fuse.
4. Replace the old fuse with a specified fuse.
5. Install the fuse seat again.

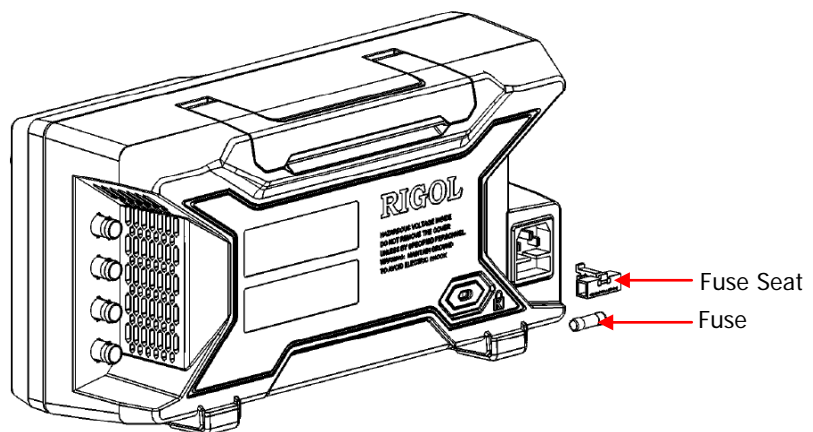

Figure 1-8 To Replace the Fuse



WARNING

To avoid electric shock, please make sure that the instrument has been turned off and the power supply has been cut off before replacing the fuse. Besides, please make sure that the fuse to be installed meets the requirement.

User Interface

DG4000 user interface displays the parameters and waveforms of the two channels at the same time. The figure below is the interface when both CH1 and CH2 select Sine. Different contents will be displayed when different functions are enabled.

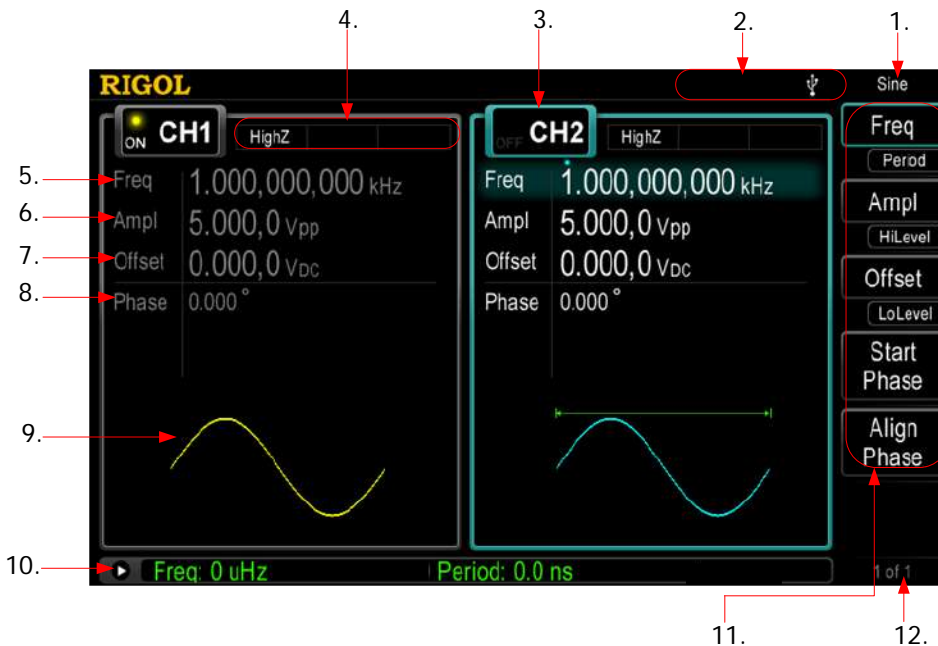





Figure 1-9 User Interface

1. Current Function

Display the name of the function currently selected. For example, "Sine" indicates that "Sine" waveform function is currently selected and "ArbEdit" indicates that "Arbitrary Waveform Edit" function is currently selected.

2. Status Bar

The following indicators would be displayed according to the current configuration.

-  When the instrument is correctly connected to the LAN, this indicator will light.
-  When the generator works in remote mode, this indicator will light.
-  When the generator detects a USB storage device, this indicator will light.

3. Channel Status

Display areas of CH1 and CH2. Indicate whether the corresponding channel is selected and turned on (ON/OFF). The area of the channel currently selected is highlighted and the on/off state of the channel currently turned on is "ON".

Note:

When a channel is "Selected", it does not mean that the channel is turned on. When CH1 is selected, users can configure the parameters of CH1 and the backlight of **CH1** turns on. When CH1 is turned on, CH1 can output waveform according to the current configuration and the backlight of **Output1** turns on.

4. Channel Configurations

Display the current output configuration in each channel, including output resistance, mode and type of modulating source or trigger source.

- **Output Resistance**

High Impedance: display "HighZ"

Load: display the resistance value, the default is "50Ω"

- **Mode**

Modulation: display "Mod"

Sweep: display "Sweep"

Burst: display "Burst"

- **Modulating/Trigger Source Type**

Internal modulating/trigger: display "Internal"

External modulating/trigger: display "External"

Manual Trigger: display "Manual"

5. Frequency

Display the current waveform frequency in each channel. Press the corresponding softkey **Freq** and use the numeric keyboard or direction keys and knob to modify this parameter. The parameter that can be modified currently will be highlighted and the lightspot above the number indicates current cursor location.

6. Amplitude

Display the current waveform amplitude in each channel. Press the corresponding softkey **Ampl** and use the numeric keyboard or direction keys and knob to modify this parameter. The parameter that can be modified

currently will be highlighted and the lightspot above the number indicates current cursor location.

7. Offset

Display the current waveform DC offset in each channel. Press the corresponding softkey **Offset** and use the numeric keyboard or direction keys and knob to modify this parameter. The parameter that can be modified currently will be highlighted and the lightspot above the number indicates current cursor location.

8. Phase

Display the current waveform phase in each channel. Press the corresponding softkey **Start Phase** and use the numeric keyboard or direction keys and knob to modify this parameter. The parameter that can be modified currently will be highlighted and the lightspot above the number indicates current cursor location.

9. Waveform

Display the currently selected waveform shape in each channel.

10. Counter

The brief information of the counter will only be displayed when the frequency counter function is turned on and the interface currently displayed is not the frequency counter interface.

- When the statistic function is turned off: only display the frequency and period.
- When the statistic function is turned on: display the measurement parameters currently selected, the on/off status of the statistic function, the measurement values and the number of measurements.

11. Menu

Display the operation menu corresponding to the function currently selected. For example, the "Sine" function menu is displayed in the above figure.

12. Menu Page Number

Display the total number of pages and the current page number of the menu, such as "1 of 1" or "1 of 2".

Parameter Setting Method

Users can use the numeric keyboard or knob and direction keys to set parameters.

Numeric Keyboard



The numeric keyboard consists of:

- **Number Keys**
The 0 to 9 number keys are used to directly input the desired parameter value.
- **Decimal Point**
Press this key to insert a decimal point "." at the current position of the cursor.
- **Operator Key**
The operator key "+/-" is used to modify the operator of the parameter. Press this key to set the parameter operator to "-"; press this key again to switch the operator to "+".
Note: The operator key is used to switch between uppercase and lowercase during filename editing.
- **Enter Key**
Press this key to finish parameter input and add the default unit for the parameter.
- **Cancel Key**
 - (1) During parameter input, press this key to clear the input in the active function area and exit parameter input.
 - (2) Turn the display in the active function area off.
- **Del Key**
 - (1) During parameter input, press this key to delete the character at the left of the cursor.
 - (2) During filename edit, press this key to delete the characters input.

Direction keys and Knob



Functions of the direction keys:

1. During parameter input, use the direction keys to move the cursor to select the digit to be edited.
2. During filename edit, use the direction keys to move the cursor.



Functions of the knob:

- When the parameter is in editable state, turn the knob to increase (clockwise) or reduce (counterclockwise) the parameter with specified step.
- During filename edit, use the knob to select the characters in the soft keyboard.
- In **Arb** → **Select Wform** → **BuiltIn** and **Utility** → **UserKey**, use the knob to select arbitrary waveform.
- In store and recall, use the knob to select the storage location of the file or to select the file to be recalled.

To Use the Built-In Help

To get context help information about any front-panel key or menu softkey, press **Help** to illuminate the key and then press the desired key to get corresponding help.

Pressing **Help** twice will get the following common help.

1. **View the last displayed message.**
2. **View error queue of the remote commands.**
3. **Get the help information of a key.**
4. **Generate a basic waveform.**
5. **Generate an arbitrary waveform.**
6. **Generate a modulated waveform.**
7. **Generate a frequency Sweep.**
8. **Generate a Burst waveform.**
9. **Storage management.**
10. **Synchronize multiple Generators.**
11. **Seamlessly connected with the RIGOL DS.**
12. **Get technical support from RIGOL.**

To Use the Security Lock

Use the security lock (option) to lock the generator at a fixed location. As shown in the figure below, align the lock with the lock hole and plug it into the lock hole vertically, turn the key clockwise to lock the instrument and then pull the key out.



Figure 1-10 Security Lock Hole

Chapter 2 Basic Waveform Output

DG4000 can output basic waveforms (including Sine, Square, Ramp, Pulse and Noise) from one of the channels separately or from the two channels at the same time. At start-up, the channel is configured as a sine waveform with 1kHz frequency and 5Vpp amplitude by default. This chapter introduces how to configure the instrument to output various basic waveforms.

Subjects in this chapter:

- To Select the Channel
- To Select Basic Waveform
- To Set the Frequency
- To Set the Amplitude
- To Set the DC Offset Voltage
- To Set the Start Phase
- Align Phase
- To Set the Duty Cycle
- To Set the Symmetry
- To Set the Pulse Parameters
- To Enable the Channel Output
- Basic Waveform Output Example

To Select the Channel

Users can configure DG4000 to output basic waveform from a single channel or from dual channels at the same time. Please select the desired channel before configuring waveform parameters. At start-up, CH1 is selected by default.

Press **CH1** or **CH2** at the front panel and the corresponding area in the user interface is illuminated. At this point, users can configure the waveform and parameters of the channel selected.

Note: CH1 and CH2 cannot be selected at the same time. Users can first select CH1 and then select CH2 after configuring the waveform and parameters of CH1.

To Select Basic Waveform

DG4000 can output 5 kinds of basic waveforms including Sine, Square, Ramp, Pulse and Noise. At start-up, Sine is selected by default.

1. Sine

Press **Sine** at the front panel to select sine waveform and the backlight of the button turns on. At this point, "Sine" and the parameter setting menu of sine waveform are displayed on the right of the user interface.

2. Square

Press **Square** at the front panel to select square waveform and the backlight of the button turns on. At this point, "Square" and the parameter setting menu of square waveform are displayed on the right of the user interface.

3. Ramp

Press **Ramp** at the front panel to select ramp waveform and the backlight of the button turns on. At this point, "Ramp" and the parameter setting menu of ramp waveform are displayed on the right of the user interface.

4. Pulse

Press **Pulse** at the front panel to select pulse and the backlight of the button turns on. At this point, "Pulse" and the parameter setting menu of pulse are displayed on the right of the user interface.

5. Noise

Press **Noise** at the front panel to select noise and the backlight of the button turns on. At this point, "Noise" and the parameter setting menu of noise are displayed on the right of the user interface.

To Set the Frequency

Frequency is one of the most important parameters of basic waveforms. For different instrument models and different waveforms, the setting ranges of frequency are different. For detailed information, please refer to "Frequency Characteristics" in "**Specifications**". The default frequency is 1kHz.

The frequency displayed on the screen is the default value or the frequency previously set. When the instrument function is changed, if this frequency is valid under the new function, the instrument will still use this frequency; otherwise, the instrument would display prompt message and set the frequency to the frequency upper limit of the new function automatically.

Press **Freq/Period** to highlight "Freq". At this point, use the numeric keyboard to input the frequency value and select the desired unit from the pop-up unit menu or use the direction keys and knob to modify the current value.

- For the input method of frequency value, refer to the introduction in "**Parameter Setting Method**".
- The frequency units available are MHz, kHz, Hz, mHz and μ Hz.
- Press this softkey again to switch to period setting. At this point, "Period" is highlighted.
- The period units available are sec, msec, μ sec and nsec.

To Set the Amplitude

The amplitude range is limited by the "Resistance" and "Freq/Period" settings. Please refer to "Output Characteristics" in "**Specifications**". The default value is 5Vpp.

The amplitude displayed on the screen is the default value or the amplitude previously set. When the instrument configuration (such as frequency) is changed, if this amplitude is valid, the instrument will still use this amplitude; otherwise, the instrument would display prompt message and set the amplitude to the amplitude upper limit of the new configuration automatically. Users can also use "High Level" or "Low Level" to set the amplitude.

Press **Ampl/HiLevel** to highlight "Ampl". At this point, use the numeric keyboard to input the amplitude value and select the desired unit from the pop-up unit menu or use the direction keys and knob to modify the current value.

- For the input method of amplitude value, refer to the introduction in "**Parameter Setting Method**".
- The amplitude units available are Vpp, mVpp, Vrms, mVrms and dBm (not available in HighZ).
- Press this softkey again to switch to high level setting. At this point, "HiLevel" is highlighted.
- The high level units available are V and mV.

Tips:**1. Switch between Vpp and Vrms**

Vpp is the unit for the signal peak-peak value and Vrms is the unit for the signal effective value. The default unit of the instrument is Vpp. Users can quickly switch the current amplitude unit from the front panel.

For different waveforms, the relations between Vpp and Vrms are different. Take sine waveform as an example; the relation of the two units is as shown in the figure below.

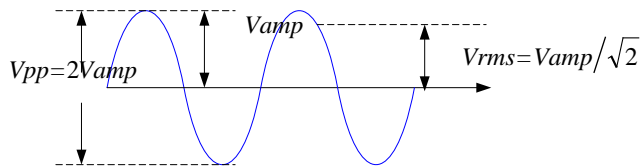

According to the figure above, the conversion relation between Vpp and Vrms fulfills the following equation.

$$V_{pp} = 2\sqrt{2}V_{rms}$$

For example, to convert 2Vpp to the corresponding value in Vrms. Press \square in the numeric keyboard and select the Vrms menu. For sine waveform, the converted value is 707.2mVrms.

2. How to set the waveform amplitude in dBm?**Method (Take CH1 as an Example):**

- 1) Press **CH1** to select CH1.
- 2) Press **Utility** → **CH1Set** → **Resi** to select "Load" and use the numeric keyboard (or the direction keys and knob) to set a proper resistance value.
- 3) Select the desired waveform; press **Ampl/HiLevel** to highlight "Ampl"; use the numeric keyboard to input the desired value and select dBm in the pop-up menu.

dBm is the unit for the absolute value of the signal power. dBm and Vrms

fulfill the following relation equation.

$$dBm = 10 \lg \left(\frac{V_{rms}^2}{R} \times \frac{1}{0.001W} \right)$$

Wherein, R denotes the output impedance of the channel and must be a specific value; therefore, when the output impedance is HighZ, dBm cannot be used.

For example, when the output impedance is 50Ω and the amplitude is $1.768V_{rms}$ (namely $5V_{pp}$), press in the numeric keyboard to select dBm to convert the amplitude to the corresponding value ($17.9601dBm$) in dBm.

To Set the DC Offset Voltage

The settable range of the DC offset voltage is limited by the "Resistance" and "Ampl/HiLevel" settings. Please refer to the "Output Characteristics" in "**Specifications**". The default value is $0V_{DC}$.

The DC offset voltage displayed on the screen is the default value or the offset previously set. When the instrument configuration (such as resistance) is changed, if this offset is valid, the instrument will still use this offset; otherwise, the instrument would display prompt message and set the offset to the offset upper limit of the new configuration automatically.

Press **Offset/LoLevel** to highlight "Offset". At this point, use the numeric keyboard to input the offset value and select the desired unit from the pop-up unit menu or use the direction keys and knob to modify the current value.

- For the input method of offset value, refer to the introduction in "**Parameter Setting Method**".
- The DC offset voltage units available are V_{DC} and mV_{DC} .
- Press this softkey again to switch to low level setting. At this point, "LoLevel" is highlighted.
- The low level units available are V and mV.

To Set the Start Phase

The setting range of start phase is from 0° to 360° and the default is 0°.

The start phase displayed on the screen is the default value or the phase previously set. When the instrument function is changed, the new function will still use this phase.

Press **Start Phase** to highlight the softkey. At this point, use the numeric keyboard to input the start phase value and select the unit "°" from the pop-up unit menu or use the direction keys and knob to modify the current value. For the input method of phase value, refer to the introduction in "**Parameter Setting Method**".

Align Phase

DG4000 series dual-channel function/arbitrary waveform generator provides the align phase function. Press **Align Phase** and the instrument will re-configure the two channels to make them output with the specified frequency and phase.

For two signals whose frequencies are the same or in multiple, this operation will align their phases. For example, assume a sine waveform (1kHz, 5Vpp, 0 °) is output from CH1, while another (1kHz, 5Vpp, 180°) from CH2. Use an oscilloscope to sample and display the waveforms of the two channels. You will see that the phase deviation of the two waveforms displayed on the oscilloscope is not 180°. At this point, press **Align Phase** on the generator and the waveforms shown on the oscilloscope will have a phase deviation of 180° without any adjustment of the start phase of the generator.

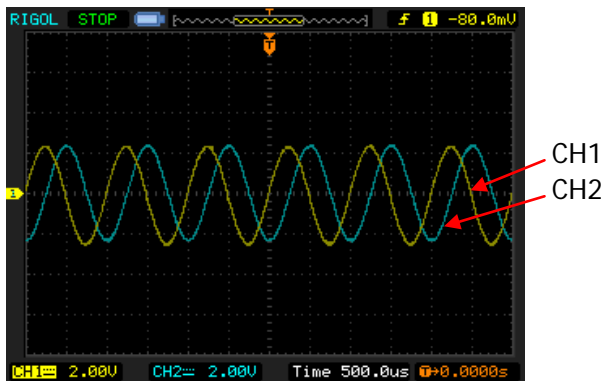

Figure 2-1 Before Aligning Phase

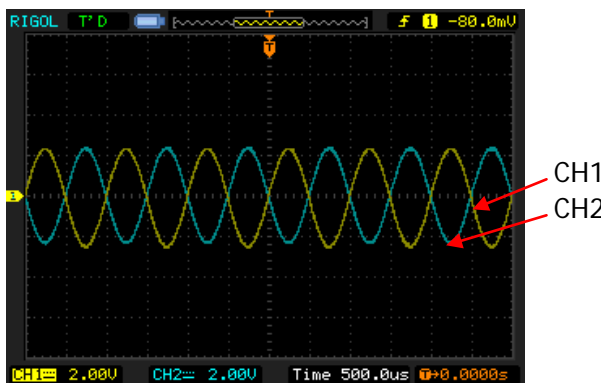
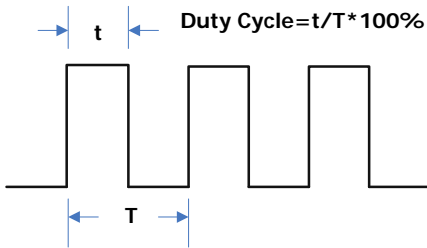

Figure 2-2 After Aligning Phase

Note: The **Align Phase** menu is grayed out and disabled when one of the two channels is in modulation mode.

To Set the Duty Cycle

Duty Cycle is defined as the percentage that the high level takes up in the whole period as shown in the figure below.



The duty cycle range is limited by the "**Freq/Period**" setting. Please refer to "Signal Characteristics" in "**Specifications**". The default value is 50%.

Press **Duty Cycle** to highlight the softkey. At this point, use the numeric keyboard to input the duty cycle value and select the unit "%" from the pop-up unit menu or use the direction keys and knob to modify the current value. For the input method of duty cycle value, refer to the introduction in "**Parameter Setting Method**".

To Set the Symmetry

Symmetry is defined as the percentage that the rising period takes up in the whole period as shown in the figure below. This parameter is only available when ramp is selected.

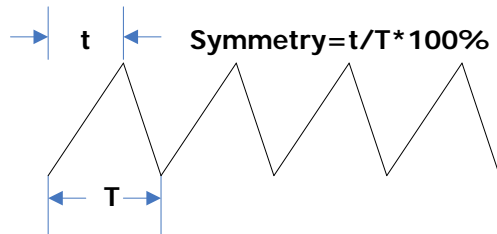

The setting range of symmetry is from 0% to 100% and the default is 50%.

Press **Symmetry** to highlight the softkey. At this point, use the numeric keyboard to input the symmetry value and select the unit "%" from the pop-up unit menu or use the direction keys and knob to modify the current value. For the input method of symmetry value, refer to the introduction in "**Parameter Setting Method**".

To Set the Pulse Parameters

To output a pulse, users need to set the "Width/Duty", "Leading" and "Trailing", in addition to the basic parameters (such as the frequency, amplitude, DC offset voltage, start phase, high level, low level and align phase) introduced above.

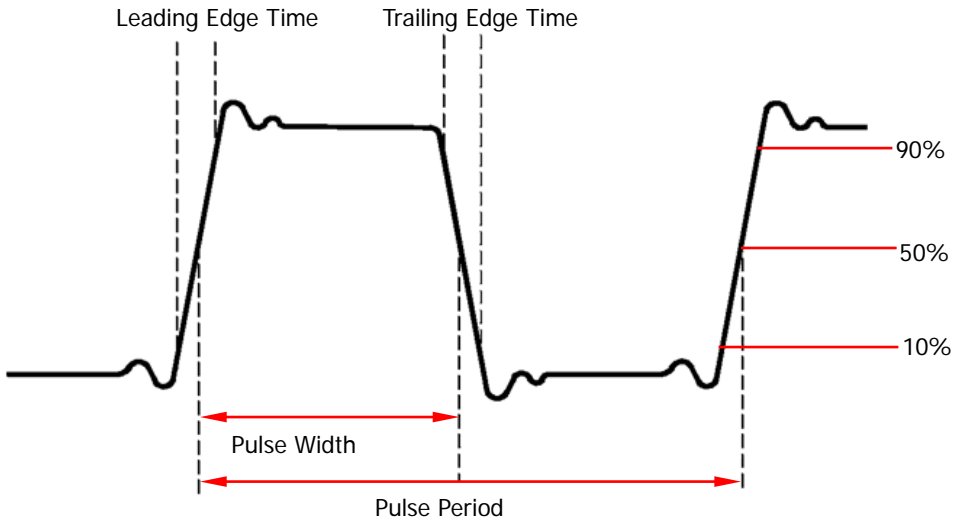

Pulse Width/Duty Cycle

Pulse width is defined as the time from the 50% threshold of a rising edge amplitude to the 50% threshold of the next falling edge amplitude as shown in the figure above.

The settable range of the pulse width is limited by the "Minimum Pulse Width" and the "Pulse Period" (for the ranges of the "Minimum Pulse Width" and "Pulse Period", please refer to "Signal Characteristics" in "**Specifications**"). The default value is 500 μ s.

- Pulse Width \geq Minimum Pulse Width
- Pulse Width \leq Pulse Period - Minimum Pulse Width \times 2

Pulse duty cycle is defined as the percentage that the pulse width takes up in the whole pulse period.

The pulse width and pulse duty cycle are correlative. Once a parameter is changed, the other will be automatically changed. The pulse duty cycle is limited by the "Minimum Pulse Width" and "Pulse Period".

- Pulse Duty Cycle \geq Minimum Pulse Width \div Pulse Period \times 100%
- Pulse Duty Cycle \leq (1 - 2 \times Minimum Pulse Width \div Pulse Period) \times 100%

Press **Width/Duty** to highlight "Width". At this point, use the numeric keyboard to input the desired value and select the desired unit from the pop-up unit menu or use the direction keys and knob to modify the current value.

- For the input method of the value, refer to the introduction in "**Parameter Setting Method**".
- Selectable Pulse Width units: sec, msec, μ sec, nsec.
- Press this softkey again to switch to the duty cycle setting.

Leading/Trailing Edge Time

The leading (rising) edge time is defined as the time required for the pulse amplitude to rise from 10% threshold to 90% threshold; while the trailing (falling) edge time is defined as the time required for the pulse amplitude to fall from 90% threshold to 10% threshold as shown in the figure above.

The range of the leading/trailing edge time is limited by the pulse width currently specified as shown in the formula below. DG4000 will automatically adjust the edge time to match the specified pulse width if the value currently set exceeds the limit value.

$$\text{Leading/Trailing Edge Time} \leq 0.625 \times \text{Pulse Width}$$

Press **Leading** (or **Trailing**) to highlight the softkey. Use the numeric keyboard to input the desired value and select the desired unit from the pop-up unit menu or use the direction keys and knob to modify the current value.

- For the input method of the value, refer to the introduction in "**Parameter Setting Method**".
- Selectable leading/trailing edge time units: sec, msec, μ sec and nsec.
- The leading edge time and trailing edge time are independent from each other and users can set them separately.

To Enable the Channel Output

After configuring the parameters of the waveform selected, waveform output could be enabled.

Note: Before enabling the channel, you can also configure the parameters (such as the resistance and polarity) related to the output of the corresponding channel through the channel setting menu (**CH1Set** or **CH2Set**) in **Utility**. For the details, please refer to the introduction in "**Channel Setting**".

Press **Output1** or/and **Output2** at the front panel and the backlight of the button turns on. The instrument outputs the configured waveform from the **[Output1]** or/and **[Output2]** connector at the front panel.

Basic Waveform Output Example

Configure the generator to output a pulse waveform with 1.5MHz frequency, 500mVpp amplitude, 5mV_{DC} DC offset, 200ns pulse width, 75ns leading (rising) edge time and 100ns trailing (falling) edge time.

1. Press **CH1** at the front panel and the backlight turns on, indicating that CH1 is selected.
2. Press **Pulse** at the front panel and the backlight turns on, indicating that Pulse waveform is selected.
3. Press **Freq/Period** to highlight "Freq". The lightspot above the number indicates current cursor location (as shown in the figure below). Use the numeric keyboard to input the frequency value "1.5" and select the unit "MHz" from the pop-up menu.

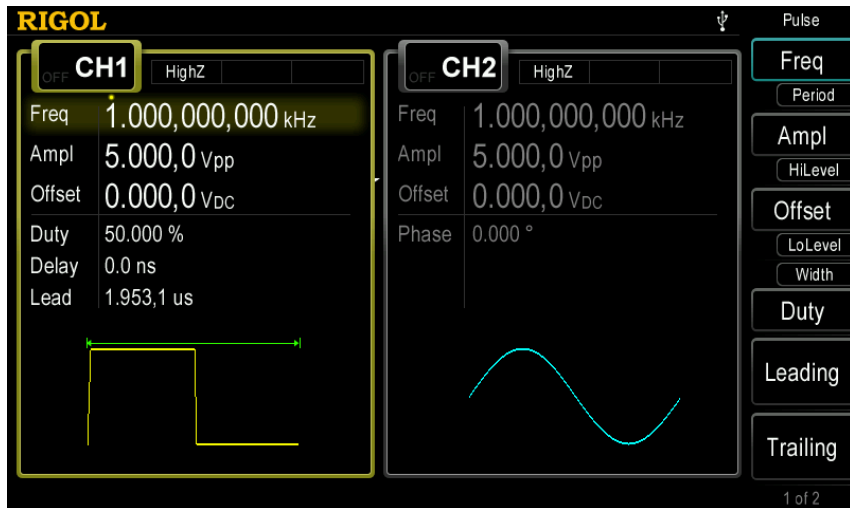

Figure 2-3 To Set Waveform Parameters

4. Press **Ampl/HiLevel** to highlight "Ampl". The lightspot above the number indicates current cursor location. Use the numeric keyboard to input the amplitude value "500" and select the unit "mVpp" from the pop-up menu.
5. Press **Offset/LoLevel** to highlight "Offset". The lightspot above the number

indicates current cursor location. Use the numeric keyboard to input the offset value "5" and select the unit "mV_{DC}" from the pop-up menu.

6. Press **Width/Duty** to highlight "Width". The lightspot above the number indicates current cursor location. Use the numeric keyboard to input "200" and select the unit "nsec" from the pop-up menu. At this point, the pulse duty cycle changes accordingly.
7. Press **Leading** to highlight it. The lightspot above the number indicates current cursor location. Use the numeric keyboard to input "75" and select the unit "nsec" from the pop-up menu. Press **Trailing** to highlight it. The lightspot above the number indicates current cursor location. Use the numeric keyboard to input "100" and select the unit "nsec" from the pop-up menu.
8. Press **Output1** at the front panel to turn the CH1 output on. At this point, the instrument outputs the specified waveform from CH1 according to the current configuration. Connect the output terminal of CH1 to the oscilloscope and the waveform is as shown in the figure below.

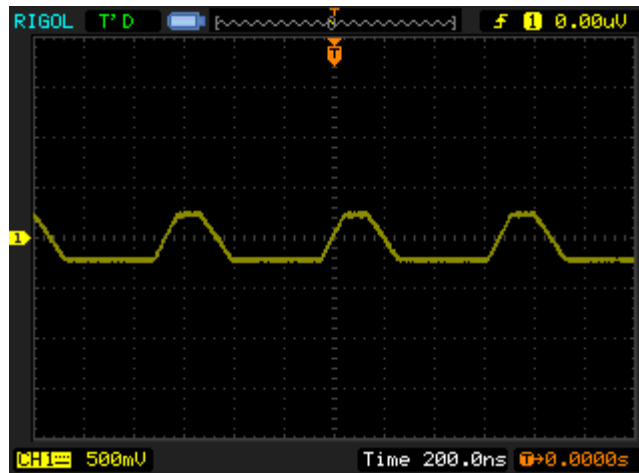

Figure 2-4 To Output Pulse Waveform

Chapter 3 Arbitrary Waveform Output

DG4000 can output the built-in waveforms and user-defined arbitrary waveforms from a single channel or from two channels at the same time. The 150 kinds of built-in waveforms are stored in the internal non-volatile memory. The user-defined arbitrary waveforms can contain 2 to 16384 (16k) data points, namely 2pts to 16kpts. Users can edit the user-defined arbitrary waveforms on the instrument or edit the arbitrary waveforms via the PC software and then download them to the instrument. Users can also store the user-defined arbitrary waveforms to the internal non-volatile memory or external memory (USB storage device) of the instrument and recall them when necessary.

This chapter introduces how to configure the generator to output arbitrary waveforms.

Subjects in this chapter:

- To Enable Arbitrary Waveform
- Point By Point Output Mode
- To Select Arbitrary Waveform
- To Create an Arbitrary Waveform
- To Edit Arbitrary Waveform

To Enable Arbitrary Waveform

Press **Arb** to enable arbitrary waveform function and open the operation menu of arbitrary waveform.

1. **Freq/Period:** set the "Freq/Period" of the arbitrary waveform.
2. **Ampl/HiLevel:** set the "Ampl/HiLevel" of the arbitrary waveform.
3. **Offset/LoLevel:** set the output "Offset/LoLevel" of the arbitrary waveform.
4. **Phase:** set the "Start Phase" of the arbitrary waveform.
5. **Align Phase:** refer to "**Align Phase**".
6. **Point By Point:** enable the point by point output mode of arbitrary waveform.
7. **Select Wform:** select the built-in waveforms, user-defined arbitrary waveforms stored in the internal or external memory of the instrument, volatile waveforms or DC.
8. **Create New:** create a new arbitrary waveform and overwrite the waveform currently in the volatile memory. Users can define 2pts to 16 kpts arbitrary waveforms.
9. **Edit Wform:** edit the waveform currently in the volatile memory.

Refer to "**Basic Waveform Output**" to configure the parameters and output. This chapter will focus on "Point By Point", "Select Waveform", "Create New" and "Edit Waveform".

Tip

Users can use **User** to quickly recall the built-in waveforms or waveforms stored in the non-volatile memory of the instrument. After you define the waveform to be recalled by this key, pressing this key will immediately recall the specified waveform. Users can press **Utility** → **UserKey** to modify the waveform to be recalled by this key (refer to introduction in "**User-defined Waveform Key**").

Point By Point Output Mode

DG4000 supports point by point output of arbitrary waveform. Press **Arb** to open the arbitrary waveform setting menu and press **Point By Point** to enable the point by point output mode of arbitrary waveform.

In point by point output mode, the generator calculates the frequency (30.517578125kHz) of the output signal automatically according to the wave table length (16,384) and sample rate. The generator outputs waveform points one by one at this fixed frequency. Point by point output mode can prevent the loss of important waveform points.

To Select Arbitrary Waveform

DG4000 allows users to select arbitrary waveforms stored in internal or external memory for output. Press **Arb** → **Select Wform** to select "Builtin", "Stored Wforms", "Volatile Wform" or "DC" for output.

Built-In Waveform

Select from the 150 kinds of built-in arbitrary waveforms of DG4000 as shown in the table below. Press **BuiltIn** and select a kind ("Common", "Project", "SectMod", "Bioelect", "Medical", "Standard", "Maths", "Trigonome", "Anti Trigonome" or "Window"); the corresponding waveforms are displayed on the interface; use the knob to select the desired waveform and press **Select** to select the specified waveform.

Table 3-1 Built-in Waveform Table

Name	Explanation
Common	
DC	DC signal
AbsSine	Absolute value of a Sine
AbsSineHalf	Absolute value of half a Sine
AmpALT	Gain oscillation curve
AttALT	Attenuation oscillation curve
GaussPulse	Gauss pulse
NegRamp	Negative ramp
NPulse	Negative pulse
PPulse	Positive pulse
SineTra	Sine-Tra waveform
SineVer	Sine-Ver waveform
StairDn	Stair-down waveform
StairUD	Stair-up and stair-down waveform
StairUp	Stair-up waveform
Trapezia	Trapezoid waveform
Project	

BandLimited	Bandwidth-limited signal
BlaseiWave	Time-velocity curve of explosive vibration
Butterworth	Butterworth filter
Chebyshev1	Chebyshev1 filter
Chebyshev2	Chebyshev2 filter
Combin	Combination function
CPulse	C pulse
CWPulse	CW pulse
DampedOsc	Time-displacement curve of damped oscillation
DualTone	Dual-tone signal
Gamma	Gamma signal
GateVibar	Gate self-oscillation signal
LFMPulse	Linear FM pulse
MCNoise	Mechanical construction noise
Discharge	Discharge curve of Ni-MH battery
Pahcur	Current waveform of DC brushless motor
Quake	Analog quake waveform
Radar	Analog radar waveform
Ripple	Ripple wave of battery
RoundHalf	RoundHalf wave
RoundsPM	RoundsPM waveform
StepResp	Step-response signal
SwingOsc	Kinetic energy- time curve of swing oscillation
TV	TV signal
Voice	Voice signal
Sec-Mod	
AM	Sectioned sine AM signal
FM	Sectioned sine FM signal
PFM	Sectioned pulse FM signal
PM	Sectioned sine PM signal
PWM	Sectioned PWM signal
Bioelect	
Cardiac	Cardiac signal
EOG	Electro-Oculogram
EEG	Electroencephalogram
EMG	Electromyogram

Pulseilogram	Pulsilogram
ResSpeed	Speed curve of the respiration
Medical	
LFPulse	Waveform of the low frequency pulse electrotherapy
Tens1	Waveform 1 of the nerve stimulation electrotherapy
Tens2	Waveform 2 of the nerve stimulation electrotherapy
Tens3	Waveform 3 of the nerve stimulation electrotherapy
Standard	
Ignition	Ignition waveform of the automotive motor
ISO16750-2 SP	Automotive starting profile with ringing
ISO16750-2 VR	Automotive supply voltage profile for resetting
ISO7637-2 TP1	Automotive transients due to disconnects
ISO7637-2 TP2A	Automotive transients due to inductance in wiring
ISO7637-2 TP2B	Automotive transients due ignition switching off
ISO7637-2 TP3A	Automotive transients due to switching
ISO7637-2 TP3B	Automotive transients due to switching
ISO7637-2 TP4	Automotive supply profile during starting
ISO7637-2 TP5A	Automotive transients due to battery disconnect
ISO7637-2 TP5B	Automotive transients due to battery disconnect
SCR	SCR firing profile
Surge	Surge signal
Math	
Airy	Airy function
Besselj	BesselI function
Bessely	BesselII function
Cauchy	Cauchy distribution function
Cubic	Cubic function
Dirichlet	Dirichlet function
Erf	Error function
Erfc	Complementary error function
ErfcInv	Inverted complementary error function
ErfInv	Inverted error function
ExpFall	Exponential fall function
ExpRise	Exponential rise function
Gauss	Gauss distribution
HaverSine	HaverSine function

Laguerre	4-times Laguerre polynomial
Laplace	Laplace distribution
Legend	5-times Legend polynomial
Log	Logarithm function with the base 10
LogNormal	Logarithmic Gaussian distribution
Lorentz	Lorentz function
Maxwell	Maxwell distribution
Rayleigh	Rayleigh distribution
Versiera	Versiera
Weibull	Weibull distribution
ARB_X2	Square function
Trigonome	
CosH	Hyperbolic cosine
CosInt	Integral cosine
Cot	Cotangent
CotHCon	Concave hyperbolic cotangent
CotHPro	Protuberant hyperbolic cotangent
CscCon	Concave cosecant
CscPro	Protuberant cosecant
CscHCon	Concave hyperbolic cosecant
CscHPro	Protuberant hyperbolic cosecant
RecipCon	Concave reciprocal
RecipPro	Protuberant reciprocal
SecCon	Concave secant
SecPro	Protuberant secant
SecH	Hyperbolic secant
Sinc	Sinc function
SinH	Hyperbolic sine
SinInt	Integral sine
Sqrt	Square root
Tan	Tangent
TanH	Hyperbolic tangent
Anti Trigonome	
ACos	Arc cosine
ACosH	Arc hyperbolic cosine
ACotCon	Concave arc cotangent

ACotPro	Protuberant arc cotangen
ACotHCon	Concave arc hyperbolic cotangent
ACotHPro	Protuberant arc hyperbolic cotangent
ACscCon	Concave arc cosecant
ACscPro	Protuberant arc cosecant
ACscHCon	Concave arc hyperbolic cosecant
ACscHPro	Protuberant arc hyperbolic cosecant
ASecCon	Concave arc secant
ASecPro	Protuberant arc secant
ASecH	Arc hyperbolic secant
ASin	Arc Sinc
ASinH	Arc hyperbolic sine
ATan	Arc tangent
ATanH	Arc hyperbolic tangent
Window	
Bartlett	Bartlett window
BarthannWin	Modified Bartlett-Hann window
Blackman	Blackman window
BlackmanH	BlackmanH window
BohmanWin	Bohman window
Boxcar	Rectangle window
ChebWin	Chebyshev window
FlattopWin	Flat Top weighted window
Hamming	Hamming window
Hanning	Hanning window
Kaiser	Kaiser window
NuttallWin	Nuttall-defined minimum 4-term Blackman-Harris window
ParzenWin	Parzen window
TaylorWin	Taylor window
Triang	Triangle window (Fejer window)
TukeyWin	Tukey (tapered cosine) window

Stored Waveform

Select the user-defined arbitrary waveforms stored in the internal non-volatile memory (C Disk) or external memory (D Disk). Press this softkey to enter the Store/Recall Interface and the **Store** key at the front panel is illuminated. Please select and read the desired arbitrary waveform file. For more details, please refer to "**Store and Recall**". Waveform data in volatile memory will be changed after the file is read. To return to arbitrary waveform setting interface, press **Arb**.

Volatile Waveform

Select the waveform data currently stored in the volatile memory. Note that this menu is not available if there is no waveform data in the volatile memory currently. At this point, you can use the following methods to fill up the volatile memory.

- Press **Arb** → **Create Wform** to create an arbitrary waveform.
- Press **Arb** → **Select Wform** → **Stored Wforms** to select a waveform stored.
- Press **Arb** → **Edit Wform** → **Select Wform** to select a built-in waveform or a waveform stored.

When "Volatile Wforms" is selected, users can edit the volatile waveform using the **Edit Wform** menu. The new waveform data will overwrite the previous data in the volatile memory. You can also save the new volatile waveform in non-volatile memory.

Note: Only when **Output1** or/and **Output2** is pressed and the backlight of the button turns on, can the instrument output the specified arbitrary waveform from the corresponding output terminal.

To Create an Arbitrary Waveform

Press **Arb**, use  to open the 2/2 menu page, and then press **Create Wform** to open the arbitrary waveform creation interface.

1. Cycle Period

Press this softkey and use the numeric keyboard or direction keys and knob to set the cycle period of the new waveform. The range is from 20.0ns to 1Ms.

Note: The time of the last point that can be defined should be lower than the cycle period.

2. HiLevel

Press this softkey and use the numeric keyboard or direction keys and knob to set the high level of the new waveform. The high level is the maximum voltage that can be set during the waveform editing. The high level must be greater than the "LoLevel" currently set and lower than or equal to +5V (50Ω).

3. LoLevel

Press this softkey and use the numeric keyboard or direction keys and knob to set the low level of the new waveform. The low level is the minimum voltage that can be set during waveform edit. The low level must be greater than or equal to -5V (50Ω) and lower than the "HiLevel" currently set.

4. Points

When creating a new waveform, the waveform editor will automatically create a waveform with two points. By default, point 1 is located at 0s and the time value of point 2 is slightly lower than the specified period. In addition, the levels of the two points are equal to the specified "**LoLevel**". Press this softkey and use the numeric keyboard or direction keys and knob to set the number of initial points of the new waveform. DG4000 allows users to create arbitrary waveform with 2 to 16384 (16K) points. After setting the number of initial points, you can "**Insert**" or "**Delete**" the points by referring to the introductions below if necessary.

5. Interp

Press this softkey to enable or disable the interpolation between the defined waveform points.

- **Off:** The waveform editor will hold a constant voltage level between two points and create a step waveform.
- **Linear:** The waveform editor will automatically connect the two defined points with a straight line.

6. Edit Points

Define a waveform by specifying the time and voltage of each waveform point. Press this softkey to enter the "Edit Points" interface.

- **Point:** Set the ID of the point to be edited. The default is 1. You can use the numeric keyboard or direction keys and knob to modify this parameter.
- **Time:** Set the time of the current point in a period. This setting is limited by the times of the previous and the next points. Note that the time of point 1 is fixed at 0 s.
- **Voltage:** Set the voltage of the current point in mV or V. The range of the voltage is limited by the "**HiLevel**" and "**LoLevel**".
- **Insert:** Insert a waveform point at the middle position of the currently edited point and the next edited point. When the interpolation mode is set to "Off", the voltage of the waveform point inserted is the same with that of the current point. When the interpolation mode is set to "Linear", the voltage of the waveform point inserted is the middle value of the voltage values of the current edited point and the next edited point.
- **Delete:** Delete the current point from the waveform and connect the remaining points using the current interpolation method. Note that the first waveform point and the last waveform point cannot be deleted.

7. Edit Block

Define a waveform by editing the time and voltage of the start and end points and automatically setting the points between them through linear interpolation. Press **Interp** to select "Linear", and then press this softkey to enter the "Edit Block" interface. Note that if "Linear" is not selected in **Interp**, this menu is grayed out and disabled.

- **X1:** Set the ID of the start point of the block (namely the time position of the start point). X1 should be lower than or equal to the number of initial

points and be lower than or equal to X2.

- **Y1:** Set the voltage of the start point in mV or V. The setting range of voltage is limited by the "**HiLevel**" and "**LoLevel**".
- **X2:** Set the ID of the end point of the block (namely the time position of the end point). X2 should be lower than or equal to the number of initial points and be greater than or equal to X1.
- **Y2:** Set the voltage of the end point in mV or V. The setting range of voltage is limited by the "**HiLevel**" and "**LoLevel**".
- **Execute:** Edit the points between the start and end points according to the current setting.
- **Delete:** Delete the points that can be edited between X1 and X2 and connect the start and end points using the current interpolation method. Note that the first waveform point and the last waveform point cannot be deleted.

8. Save

The currently created waveform is stored in the volatile memory by default. If the memory already contains waveform data, the previous waveform data will be overwritten.

Press **Save** to enter the file storage interface and you can store the waveform created in the internal non-volatile memory (C Disk) or external memory (D Disk) (refer to "**Store and Recall**").

Tips

Users can also use the PC software to edit arbitrary waveform; then, use the SCPI methods to store the waveform in the internal memory or external memory of the instrument (for the detailed method, refer to *DG4000 Programming Guide*).

✧ *SAV ARB1|ARB2|ARB3|ARB4|ARB5|ARB6|ARB7|ARB8|ARB9|ARB10

Store the waveform to the internal non-volatile memory of the instrument.

✧ :MMEMory:STORe <file_name>

Store the waveform to the external memory (USB storage device) of the instrument.

Example: Edit Points

The following example introduces how to use "Edit Points" to create an arbitrary waveform fulfilling the following conditions.

Parameter	Value
Cycle Period	12 μ s
HiLevel	4V
LoLevel	-2V
Interp	Linear
Point 1	0s, 0V
Point 2	4 μ s, 4V
Point 3	8 μ s, 0V
Point 4	10 μ s, -2V

Operation Procedures:

1. Press **Arb** and use  to open the 2/2 menu page; then press **Create New** → **Cycle Period**, use the numeric keyboard to input "12" and select the unit " μ sec" from the pop-up menu.
2. Press **HiLevel**, use the numeric keyboard to input "4" and select the unit "V" from the pop-up menu.
3. Press **LoLevel**, use the numeric keyboard to input "-2" and select the unit "V" from the pop-up menu.
4. Press **Points**, use the numeric keyboard to input "4" and press **OK**. Note: At this point, a -2 V level line is displayed.
5. Press **Interp** to select "Linear".
6. Press **Edit Points** to enter the "Edit Points" interface.

- 1) Press **Point** to define the first point (the time is 0 by default). Press **Voltage**, use the numeric keyboard to input "0" and select the unit "V" from the pop-up menu.
- 2) Press **Point** again, use the numeric keyboard or knob to select point 2; then press **Time** and **Voltage** to input $4\mu\text{s}$ and 4V respectively.
- 3) Refer to step 2) to input point 3 and point 4 in the table above.
- 4) After finishing editing all the points, press **OK** to return to the previous menu. At this point, press **Save** to enter the file storage interface (refer to "Store and Recall") to save the edited arbitrary waveform.

7. View the edited arbitrary waveform.

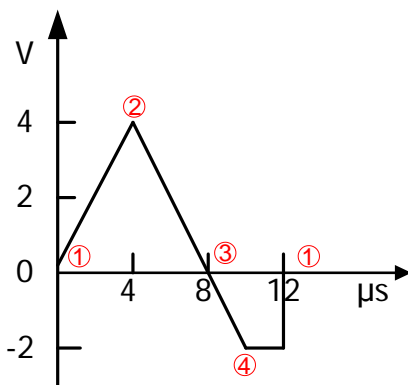

Explanation: As can be seen from the above figure, the waveform editor always connects the voltage levels of the first point to the last point in sequence and then hold this level until the cycle period expires to create a continuous waveform.

Example: Edit Block

The following example introduces how to use "Edit Block" to create an arbitrary waveform fulfilling the following conditions.

Parameter	Value
Cycle Period	12 μ s
HiLevel	4V
LoLevel	-2V
Interp	Linear
X1Y1	2, 4V
X2Y2	4, -2V

Operation Procedures:

1. Press **Arb** and use  to open the 2/2 menu page; then press **Create New** → **Cycle Period**, use the numeric keyboard to input "12" and select the unit " μ sec" from the pop-up menu.
2. Press **HiLevel**, use the numeric keyboard to input "4" and select the unit "V" from the pop-up menu.
3. Press **LoLevel**, use the numeric keyboard to input "-2" and select the unit "V" from the pop-up menu.
4. Press **Points**, use the numeric keyboard to input "4" and press **OK**. Note: At this point, a -2 V level line is displayed.
5. Press **Interp** to select "Linear".
6. Press **Edit Block** to enter the "Edit Block" interface.
 - 1) Press **X1**, use the numeric keyboard to input "2" and press **OK**. Then, press **Y1**, use the numeric keyboard to input "4" and select the unit "V" from the pop-up menu. Use the same method to set X2 and Y2.

- 2) Press **Execute** to apply the setting defined in step 1). The waveform editor will automatically use straight lines to connect the start point (point 2, the level is 4 V) with the stop point (point 4, the level is -2 V) and automatically generate point 1 and point 3 to create a continuous waveform.
- 3) After finishing editing all the points, press  to return to the previous menu. At this point, press **Save** to enter the file storage interface (refer to "Store and Recall") to save the edited arbitrary waveform.

7. View the edited arbitrary waveform.

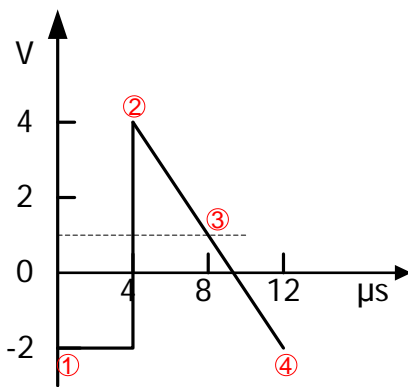

Explanation: As can be seen from the above figure, the waveform editor inserts values at the start point (point 2) and the stop point (point 4) according to the current interpolation mode; then, it automatically generates point 1 and point 3 to create a continuous waveform.

To Edit Arbitrary Waveform

Arbitrary waveforms stored in internal non-volatile memory or external memory can be edited.

Press **Arb** and use  to open the 2/2 menu page, then press **Edit Wform** to open waveform editing menu. Users can also press **Edit** at the front panel to quickly open this menu. In this menu, for the functions and operation methods of the other menus except **Select Wform**, please refer to "**To Create an Arbitrary Waveform**".

Press **Edit Wform** → **Select Wform** to select the waveform to be edited.

1. Edit Built-In waveforms

Select a waveform from the built-in waveforms to edit. You can store the edited waveform without overwriting the original built-in waveform.

2. Edit Stored Waveforms

Select a waveform from internal non-volatile memory (C Disk) or external memory (D Disk) to edit. You can overwrite the old waveform or save the new waveform as a new file.

Chapter 4 Harmonic Output

DG4000 can be used as a harmonic generator to output harmonic with specified order, amplitude and phase. It is usually used in the test of harmonic detector device or harmonic filter device. This chapter introduces how to configure the generator to output harmonics.

Subjects in this chapter:

- Overview
- To Set the Fundamental Waveform Parameters
- To Set the Harmonic Order
- To Select the Harmonic Type
- To Set the Harmonic Amplitude
- To Set the Harmonic Phase

Overview

According to Fourier transform, time domain waveform is the superposition of a series of sine waveforms as shown in the equation below:

$$f(t) = A_1 \sin(2\pi f_1 t + \varphi_1) + A_2 \sin(2\pi f_2 t + \varphi_2) + A_3 \sin(2\pi f_3 t + \varphi_3) + \dots$$

Generally, component with f_1 frequency is called fundamental waveform, f_1 is fundamental waveform frequency, A_1 is fundamental waveform amplitude and φ_1 is fundamental waveform phase. The frequencies of other components (called harmonics) are all integral multiples of the fundamental waveform frequency. Components whose frequencies are odd multiples of the fundamental waveform frequency are odd harmonics and components whose frequencies are even multiples of the fundamental waveform frequency are even harmonics.

DG4000 can output up to 16th order of harmonic. After selecting CH1 or CH2, press **Harmonic** at the front panel to enter the harmonic setting menu. Users can set the parameters of fundamental waveform, set the type of harmonic, specify the highest order of harmonic and set the amplitude and phase of each order of harmonic.

After finishing harmonic parameter setting, press **Output1** or/and **Output2** and the backlight of the button turns on, the instrument outputs the specified harmonic from the corresponding output terminal.

To Set the Fundamental Waveform Parameters

DG4000 allows users to set various fundamental waveform parameters such as frequency, period, amplitude, DC offset voltage, high level, low level and start phase. It also supports align phase operation. Please refer to introductions in "**Basic Waveform Output**" to set fundamental waveform parameters.

To Set the Harmonic Order

The highest order of harmonic output from DG4000 cannot be greater than this setting value.

After entering the harmonic setting menu, press **Order** (at this point, "Order" on the screen is highlighted) and use the numeric keyboard or the direction keys and knob to input the harmonic order. The range is limited by the maximum output frequency of the instrument as well as the fundamental waveform frequency.

- Range: integers within 2 to **maximum output frequency of the instrument ÷ fundamental waveform frequency**.
- The maximum is 16.

To Select the Harmonic Type

DG4000 can output even harmonic, odd harmonic, all orders of harmonic or user-defined orders of harmonic. After entering the harmonic setting menu, press **Type** to select the desired harmonic type.

1. Even

Press this key and the instrument would output fundamental waveform and even harmonics.

2. Odd

Press this key and the instrument would output fundamental waveform and odd harmonics.

3. All

Press this key and the instrument would output fundamental waveform and all the harmonics in order.

4. User

Press this key and the instrument would output the user-defined orders of harmonics. The highest order is 16.

16 bits binary data is used to represent the output status of the 16 orders of harmonics respectively, wherein, 1 represents enabling the output of the corresponding harmonic and 0 represents disabling the output of the corresponding harmonic. Users only need to use the numeric keyboard to modify the value of each data bit (note: The leftmost bit representing fundamental waveform is always X and cannot be modified). For example, set the 16 bit data to X001 0000 0000 0001; the instrument will output the fundamental waveform, the 4th order harmonic and 16th order harmonic.

Note: The harmonics actually output are determined by the "Order" currently specified.

To Set the Harmonic Amplitude

After entering the harmonic setting menu, press **Ampl** to set the amplitude of each order of harmonic.

1. **SN**: press this softkey to select the sequence number of the harmonic to be set.
2. **Ampl**: press this softkey to set the amplitude of the harmonic selected. Use the numeric keyboard to input the amplitude value and then select the desired unit from the pop-up menu or use the direction keys and knob to modify the current value.
 - For the input method of amplitude value, refer to the introduction in "**Parameter Setting Method**".
 - The amplitude units available are Vpp, mVpp, Vrms, mVrms and dBm (not available in HighZ).

To Set the Harmonic Phase

After entering the harmonic setting menu, press **Phase** to set the phase of each order of harmonic.

1. **SN:** press this softkey to select the sequence number of the harmonic to be set.
2. **Phase:** press this softkey to set the phase of the harmonic selected. Use the numeric keyboard to input the phase value and then select the unit "°" from the pop-up menu or use the direction keys and knob to modify the current value. For the input method of phase value, refer to the introduction in "**Parameter Setting Method**".

Chapter 5 Modulated Waveform Output

DG4000 supports AM, FM, PM, ASK, FSK, 3FSK, 4FSK, PSK, BPSK, QPSK, PWM and OSK modulations. DG4000 can output modulated waveform from a single channel or from two channels at the same time. The modulated waveform consists of carrier waveform and modulating waveform. The carrier waveform can be Sine, Square, Ramp, Arbitrary waveform (except DC) or Pulse (only in PWM). The modulating waveform can be from internal or external modulation source.

Subjects in this chapter:

- AM
- FM
- PM
- ASK
- FSK
- PSK
- BPSK
- QPSK
- 3FSK
- 4FSK
- OSK
- PWM

AM

Modulated waveform usually consists of carrier waveform and modulating waveform. For amplitude modulation (AM), the amplitude of the carrier waveform varies with the instantaneous voltage of the modulating waveform.

To Select AM Modulation

Press **Mod** → **Type** → **AM** to enable AM function.

- When **Mod** is enabled, **Sweep** or **Burst** will be disabled automatically (if enabled currently).
- After AM is enabled, the instrument will generate AM waveform with the currently specified carrier and modulating waveforms.

To Select Carrier Waveform Shape

AM carrier waveform could be Sine, Square, Ramp or Arbitrary waveform (except DC). The default is Sine.

- Press the front panel key **Sine**, **Square**, **Ramp** or **Arb** → **Select Wform** (or **User**, the pre-defined waveform cannot be DC) to select a desired carrier waveform shape.
- Pulse, Noise and DC could not be used as carrier waveform.

To Set Carrier Frequency

Different carrier waveforms have different frequency ranges as shown in the table below. For all the carrier waveforms, the default value is 1kHz.

Carrier Waveform	Frequency Range
Sine	1μHz to 160MHz
Square	1μHz to 50MHz
Ramp	1μHz to 4MHz
Arbitrary Waveform	1μHz to 40MHz

After the carrier waveform is selected, you can press **Freq/Period** to highlight "Freq", and then use the numeric keyboard or direction keys and knob to input the desired frequency value.

To Select Modulating Waveform Source

DG4000 can receive modulating waveform from internal or external modulation source. Press **Mod** → **Source** to select "Int" or "Ext" modulation source.

1. Internal Source

When internal modulation source is selected, press **Shape** to select Sine, Square, Triangle, UpRamp, DnRamp, Noise or Arb as modulating waveform. The default is Sine.

- Square: 50% duty cycle.
- Triangle: 50% symmetry.
- UpRamp: 100% symmetry.
- DnRamp: 0% symmetry.
- Arb: when arbitrary waveform is selected as modulating waveform, the generator would limit the waveform length to 2kpts automatically.

Note: Noise can be used as modulating waveform but cannot be used as carrier waveform.

2. External Source

When external modulation source is selected, the **Shape** menu will be grayed out and disabled. The generator receives the external modulating signal from the **[Mod/FSK/Trig]** connector at the rear panel. The AM modulating amplitude is controlled by the ± 2.5 V signal level of the connector.



To Set Modulating Waveform Frequency

When internal modulation source is selected, press **AM_Freq** to set the modulating waveform frequency.

- Input the desired frequency value using the numeric keyboard or direction keys and knob.
- The modulating waveform frequency ranges from 2mHz to 50kHz, and the default value is 100Hz.

Note: This menu will be grayed out and disabled when external modulation source is selected.

To Set Modulation Depth

Modulation depth expressed as a percentage indicates the amplitude variation degree. The AM modulation depth ranges from 0% to 120%. Press **AM Depth** to set AM modulation depth.

- In 0% modulation, the output amplitude is half of the specified value.
- In 100% modulation, the output amplitude is equal to the specified value.
- In >100% modulation, the output amplitude of the instrument would not exceed 10Vpp (50Ω load).

When "Ext" modulation source is selected, the output amplitude of the instrument is also controlled by the $\pm 2.5\text{V}$ signal level at the **[Mod/FSK/Trig]** connector at the rear panel. For example, set the modulation depth to 100%, the output amplitude is the maximum when the modulating signal is +2.5V and the minimum when the modulating signal is -2.5V.

Double Sideband Suppressed Carrier

DG4000 supports two kinds of amplitude modulation (normal amplitude modulation and Double Sideband Suppressed Carrier (DSB-SC) amplitude modulation). In normal amplitude modulation, the modulated waveform contains carrier components. As the carrier components do not carry information, the modulation efficiency is low. To improve the modulation efficiency, you can suppress the carrier components on the basis of the normal amplitude modulation. At this point, all the modulated waveform components carry information. This mode is called double sideband suppressed carrier modulation.

Press **DSSC** to turn on or off the double sideband suppressed carrier modulation. By default, normal amplitude modulation is used.

FM

Modulated waveform consists of carrier waveform and modulating waveform. For frequency modulation (FM), the frequency of the carrier waveform varies with the instantaneous voltage of the modulating waveform.

To Select FM Modulation

Press **Mod** → **Type** → **FM** to enable FM function.

- When **Mod** is enabled, **Sweep** or **Burst** will be disabled automatically (if currently enabled).
- After FM is enabled, the instrument will generate FM waveform with the currently specified carrier and modulating waveforms.

To Select the Carrier Waveform Shape

FM carrier waveform could be Sine, Square, Ramp or Arbitrary waveform (except DC). The default is Sine.

- Press the front panel key **Sine**, **Square**, **Ramp** or **Arb** → **Select Wform** (or **User**, the pre-defined waveform cannot be DC) to select a desired carrier waveform shape.
- Pulse, Noise and DC could not be used as carrier waveform.

To Set the Carrier Frequency

Different carrier waveforms have different frequency ranges as shown in the table below. For all the carrier waveforms, the default value is 1kHz.

Carrier Waveform	Frequency Range
Sine	1 μ Hz to 160MHz
Square	1 μ Hz to 50MHz
Ramp	1 μ Hz to 4MHz
Arbitrary Waveform	1 μ Hz to 40MHz

After the carrier waveform is selected, you can press **Freq/Period** to highlight "Freq", and then use the numeric keyboard or direction keys and knob to input the desired frequency value.

To Select the Modulating Waveform Source

DG4000 can receive modulating waveform from internal or external modulation source. Press **Mod** → **Source** to select "Int" or "Ext" modulation source.

1. Internal Source

When internal modulation source is selected, press **Shape** to select Sine, Square, Triangle, UpRamp, DnRamp, Noise or Arb as modulating waveform. The default is Sine.

- Square: 50% duty cycle.
- Triangle: 50% symmetry.
- UpRamp: 100% symmetry.
- DnRamp: 0% symmetry.
- Arb: when arbitrary waveform is selected as modulating waveform, the generator would limit the waveform length to 2kpts automatically.

Note: Noise can be used as modulating waveform but cannot be used as carrier waveform.

2. External Source

When external modulation source is selected, the **Shape** menu will be grayed out and disabled. The generator receives the external modulating signal from the **[Mod/FSK/Trig]** connector at the rear panel. The frequency deviation is controlled by the ± 2.5 V signal level of the connector.



To Set the Modulating Waveform Frequency

When internal modulation source is selected, press **FM_Freq** to set the modulating waveform frequency.

- Input the desired frequency value using the numeric keyboard or direction keys and knob.
- The modulating waveform frequency ranges from 2mHz to 50kHz, and the default value is 100Hz.

Note: This menu will be grayed out and disabled when external modulation source is selected.

To Set the Frequency Deviation

Frequency deviation is the deviation of the modulating waveform frequency relative to the carrier frequency. Press **Deviation** to set the FM frequency deviation.

- Frequency deviation must be lower than or equal to the carrier frequency.
- The sum of frequency deviation and carrier frequency must be lower than or equal to the sum of the current carrier frequency upper limit and 1kHz.

When "Ext" modulation source is selected, frequency deviation is controlled by the $\pm 2.5\text{V}$ signal level at the **[Mod/FSK/Trig]** connector at the rear panel. Positive signal level corresponds to frequency increase and negative signal level corresponds to frequency decrease. The lower the level, the less offset is generated. For example, if the frequency deviation is set to 1kHz, +2.5V signal level corresponds to a 1kHz increase of frequency and -2.5V signal level corresponds to a 1kHz decrease of frequency.

PM

Modulated waveform consists of carrier waveform and modulating waveform. For phase modulation (PM), the phase of the carrier waveform varies with the instantaneous voltage of the modulating waveform.

To Select PM Modulation

Press **Mod** → **Type** → **PM** to enable PM function.

- When **Mod** is enabled, **Sweep** or **Burst** will be automatically disabled (if currently enabled).
- After PM is enabled, the instrument will generate PM waveform with the currently specified carrier and modulating waveforms.

To Select the Carrier Waveform Shape

PM carrier waveform could be Sine, Square, Ramp or Arbitrary waveform (except DC). The default is Sine.

- Press the front panel key **Sine**, **Square**, **Ramp** or **Arb** → **Select Wform** (or **User**, the pre-defined waveform cannot be DC) to select the desired carrier waveform shape.
- Pulse, Noise and DC could not be used as carrier waveform.

To Set the Carrier Frequency

Different carrier waveforms have different frequency ranges as shown in the table below. For all the carrier waveforms, the default value is 1kHz.

Carrier Waveform	Frequency Range
Sine	1μHz to 160MHz
Square	1μHz to 50MHz
Ramp	1μHz to 4MHz
Arbitrary Waveform	1μHz to 40 MHz

After the carrier waveform is selected, you can press **Freq/Period** to highlight "Freq", and then use the numeric keyboard or direction keys and knob to input the desired frequency value.

To Select the Modulating Waveform Source

DG4000 can receive modulating waveform from internal or external modulation source. Press **Mod** → **Source** to select "Int" or "Ext" modulation source.

1. Internal Source

When internal modulation source is selected, press **Shape** to select Sine, Square, Triangle, UpRamp, DnRamp, Noise or Arb as modulating waveform. The default is Sine.

- Square: 50% duty cycle.
- Triangle: 50% symmetry.
- UpRamp: 100% symmetry.
- DnRamp: 0% symmetry.
- Arb: when arbitrary waveform is selected as modulating waveform, the generator would limit the waveform length to 2kpts automatically.

Note: Noise can be used as modulating waveform but cannot be used as carrier waveform.

2. External Source

When external modulation source is selected, the **Shape** menu will be grayed out and disabled. The generator receives the external modulating signal from the **[Mod/FSK/Trig]** (as shown in the figure below) connector at the rear panel. The phase deviation is controlled by the ± 2.5 V signal level of the connector.



To Set the Modulating Waveform Frequency

When internal modulation source is selected, press **PM_Freq** to set the modulating waveform frequency.

- Input the desired frequency value using the numeric keyboard or direction keys and knob.
- The modulating waveform frequency ranges from 2mHz to 50kHz, and the default value is 100Hz.

Note: This menu will be grayed out and disabled when external modulation source is selected.

To Set the Phase Deviation

Phase deviation is the deviation of the modulating waveform phase relative to the carrier waveform phase. Press **Deviation** to set the PM phase deviation.

- Use the numeric keyboard or direction keys and knob to input the desired phase value.
- The range of phase deviation is from 0° to 360°.

When "Ext" modulation source is selected, the phase deviation is controlled by the $\pm 2.5V$ signal level at the **[Mod/FSK/Trig]** connector at the rear panel. For example, if the phase deviation is set to 180°, +2.5V signal level corresponds to a 180° phase variation. The lower the external signal level, the less deviation would be generated.

ASK

When using ASK (Amplitude Shift Keying) modulation, you can configure the generator to "shift" its output amplitude between two preset amplitude values ("carrier amplitude" and "modulating amplitude"). The "shift" rate (ASK Rate) is determined by the internal signal level or signal level at the **[Mod/FSK/Trig]** connector at the rear panel.

To Select ASK Modulation

Press **Mod** → **Type** → **ASK** to enable ASK function.

- When **Mod** is enabled, **Sweep** or **Burst** will be disabled automatically (if enabled currently).
- After ASK is enabled, the instrument will generate ASK waveform with the currently specified carrier and modulating waveforms.

To Select the Carrier Waveform Shape

ASK carrier waveform could be Sine, Square, Ramp or arbitrary waveform (except DC). The default is Sine.

- Press the front panel key **Sine**, **Square**, **Ramp** or **Arb** → **Select Wform** (or **User**, the pre-defined waveform cannot be DC) to select the desired carrier waveform shape.
- Pulse, Noise and DC could not be used as carrier waveform.

To Set the Carrier Amplitude

After selecting carrier waveform shape, press **Ampl/HiLevel** to highlight "Ampl", and then use the numeric keyboard or direction keys and knob to input the desired amplitude. The available amplitude range is limited by **Resistance** and **Freq/Period**. Please refer to the "Output Characteristics" described in "**Specifications**".

To Select the Modulating Waveform Source

Press **Mod** → **Source** to select "Int" or "Ext" modulating waveform source.

1. Internal Source

When internal source is selected, the modulating waveform is set as a Square with 50% duty cycle, and the rate at which the output amplitude "shifts" between "carrier amplitude" and "modulating amplitude" is determined by "ASK Rate".

2. External Source

When external source is selected, the generator receives the external modulating signal from the **[Mod/FSK/Trig]** connector at the rear panel.



Note: The **[Mod/FSK/Trig]** connector is different when controlling ASK and AM/FM/PM modulations externally. In ASK modulation, the **[Mod/FSK/Trig]** connector has adjustable edge polarity.

To Set the ASK Rate

When internal source is selected, press **ASK Rate** to set the rate at which the output amplitude shifts between "carrier amplitude" and "modulating amplitude".

- Use the numeric keyboard or direction keys and knob to input the desired frequency value.
- The frequency range is from 2mHz to 1MHz and the default is 100Hz.

Note: When "Ext" modulation source is selected, this menu would be grayed out and disabled.

To Set the Modulating Amplitude

Press **ModAmp** to set the modulating amplitude.

- Use the numeric keyboard or direction keys and knob to input the desired amplitude value.
- The range of amplitude (HighZ) is from 0 to 10V and the default is 2V.

To Set the Modulating Polarity

Press **Polarity** to select the "Pos" or "Neg" polarity of the modulating waveform to control the output amplitude.

In internal modulation, set the polarity to "Pos" and the generator would output the greater of the carrier amplitude and modulating amplitude when the modulating waveform is logic high and output the lower when the modulating waveform is logic low. The situation is the opposite when the polarity is set to "Neg".

In external modulation, set the polarity to "Pos" and the generator would output the greater of the carrier amplitude and modulating amplitude when logic high level is input and output the lower when the logic low level is input. The situation is the opposite when the polarity is set to "Neg".

FSK

When FSK (Frequency Shift Keying) modulation is selected, you can configure the generator to "shift" its output frequency between two preset frequencies ("carrier frequency" and "hop frequency"). The "shift" frequency (FSK Rate) is determined by the internal signal level or signal level at the **[Mod/FSK/Trig]** connector at the rear panel.

To Select FSK Modulation

Press **Mod** → **Type** → **FSK** to enable FSK function.

- When **Mod** is enabled, **Sweep** or **Burst** will be automatically disabled (if enabled currently).
- After FSK is enabled, the instrument will generate FSK waveform with the currently specified carrier and modulating waveforms.

To Select the Carrier Waveform Shape

FSK carrier waveform could be Sine, Square, Ramp or arbitrary waveform (except DC), and the default is Sine.

- Press the front panel key **Sine**, **Square**, **Ramp** or **Arb** → **Select Wform** (or **User**, the pre-defined waveform cannot be DC) to select desired carrier waveform shape.
- Pulse, Noise and DC could not be used as carrier waveform.

To Set the Carrier Frequency

Different carrier waveforms have different frequency ranges as shown in the table below. For all the carrier waveforms, the default value is 1kHz.

Carrier Waveform	Frequency Range
Sine	1μHz to 160MHz
Square	1μHz to 50MHz
Ramp	1μHz to 4MHz
Arbitrary Waveform	1μHz to 40MHz

After the carrier waveform is selected, you can press **Freq/Period** to highlight "Freq", and then use the numeric keyboard or direction keys and knob to input the desired frequency value.

To Select the Modulating Waveform Source

Press **Mod** → **Source** to select "Int" or "Ext" modulating waveform source.

1. Internal Source

When internal source is selected, the modulating waveform is set as a Square with 50% duty cycle, and the frequency at which the output frequency shifts between "carrier frequency" and "hop frequency" is determined by "FSK Rate".

2. External Source

When external source is selected, the generator receives the external modulating signal from the **[Mod/FSK/Trig]** connector at the rear panel.



Note: The **[Mod/FSK/Trig]** connector is different when controlling FSK and AM/FM/PM modulations externally. In FSK modulation, the **[Mod/FSK/Trig]** connector has adjustable edge polarity.

To Set the FSK Rate

When internal source is selected, press **FSK Rate** to set the frequency at which the output frequency shifts between "carrier frequency" and "hop frequency".

- Use the numeric keyboard or direction keys and knob to input the desired frequency value.
- The frequency range is from 2mHz to 1MHz and the default is 100Hz.

Note: When "Ext" modulation source is selected, this menu is grayed out and disabled.

To Set the Hop Frequency

Alternating frequency ("hop" frequency) is the modulating frequency. The range of hop frequency depends on the carrier waveform currently selected. Press

HopFreq to highlight it and input the desired frequency value using the numeric keyboard or direction keys and knob.

- Sine: 1 μ Hz to 160MHz
- Square: 1 μ Hz to 50MHz
- Ramp: 1 μ Hz to 4MHz
- Arb: 1 μ Hz to 40MHz

To Set the Modulating Polarity

Press **Polarity** to select the "Pos" or "Neg" polarity of the modulating waveform to control the output frequency.

In internal modulation, set the polarity to "Pos" and the generator would output the carrier frequency when the modulating waveform is logic low and output the hop frequency when the modulating waveform is logic high. The situation is the opposite when the polarity is set to "Neg".

In external modulation, set the polarity to "Pos" and the generator would output the carrier frequency when logic low level is input and output the modulating frequency when logic high level is input. The situation is the opposite when the polarity is set to "Neg".

PSK

When PSK (Phase Shift Keying) modulation is selected, you can configure the generator to "shift" its output phase between two preset phase values ("carrier phase" and "modulating phase"). The "shift" frequency (PSK Rate) is determined by the internal signal level or signal level at the **[Mod/FSK/Trig]** connector at the rear panel.

To Select PSK Modulation

Press **Mod** → **Type** → **PSK** to enable PSK function.

- When **Mod** is enabled, **Sweep** or **Burst** will be automatically disabled (if enabled currently).
- After PSK is enabled, the instrument will generate PSK waveform with the currently specified carrier and modulating waveforms.

To Select the Carrier Waveform Shape

PSK carrier waveform could be Sine, Square, Ramp or arbitrary waveform (except DC), and the default is Sine.

- Press the front panel key **Sine**, **Square**, **Ramp** or **Arb** → **Select Wform** (or **User**, the pre-defined waveform cannot be DC) to select the desired carrier waveform shape.
- Pulse, Noise and DC could not be used as carrier waveform.

To Set the Carrier Phase

After carrier waveform shape is selected, press **Start Phase** to highlight it and use the numeric keyboard or direction keys and knob to input the desired phase. The available phase ranges from 0° to 360° and the default value is 0°.

To Select the Modulating Waveform Source

Press **Mod** → **Source** to select "Int" or "Ext" modulating waveform source.

1. Internal Source

When internal source is selected, the modulating waveform is set as a Square with 50% duty cycle, and the frequency at which the output phase shifts between "carrier phase" and "modulating phase" is determined by "PSK Rate".

2. External Source

When external source is selected, the generator receives the external modulating signal from the **[Mod/FSK/Trig]** connector (as shown in the figure below) at the rear panel.



Note: The **[Mod/FSK/Trig]** connector is different when controlling PSK and AM/FM/PM modulations externally. In PSK modulation, the **[Mod/FSK/Trig]** connector has adjustable edge polarity.

To Set the PSK Rate

When internal source is selected, press **PSK Rate** to set the frequency at which the output phase shifts between "carrier phase" and "modulating phase".

- Use the numeric keyboard or direction keys and knob to input the desired frequency value.
- The frequency range is from 2mHz to 1MHz and the default is 100Hz.

Note: When "Ext" is selected, this menu is grayed out and disabled.

To Set the PSK Phase

PSK phase is the modulating phase. Press **Phase** to set the modulating phase.

- Use the numeric keyboard or direction keys and knob to input the desired phase value.
- The phase range is from 0° to 360° and the default is 180°.

To Set the Modulating Polarity

Press **Polarity** to select the "Pos" or "Neg" polarity of the modulating waveform to control the output phase.

In internal modulation, set the polarity to "Pos" and the generator would output the carrier phase when the modulating waveform is logic low and output the modulating phase when the modulating waveform is logic high. The situation is the opposite when the polarity is set to "Neg".

In external modulation, set the polarity to "Pos" and the generator would output the carrier phase when logic low level is input and output the modulating phase when logic high level is input. The situation is the opposite when the polarity is set to "Neg".

BPSK

When BPSK (Binary Phase Shift Keying) is selected, you can configure the generator to "shift" its output phase between two preset phases ("carrier phase" and "modulating phase"). The "shift" frequency (BPSK rate) is determined by the internal signal level of the instrument.

To Select BPSK Modulation

Press **Mod** → **Type** → **BPSK** to enable BPSK function.

- When **Mod** is enabled, **Sweep** or **Burst** will be automatically disabled (if enabled currently).
- After BPSK is enabled, the instrument will generate BPSK waveform with the currently specified carrier and modulating waveforms.

To Select the Carrier Waveform Shape

BPSK carrier waveform could be Sine, Square, Ramp or arbitrary waveform (except DC), and the default is Sine.

- Press the front panel key **Sine**, **Square**, **Ramp** or **Arb** → **Select Wform** (or **User**, the pre-defined waveform cannot be DC) to select desired carrier waveform shape.
- Pulse, Noise and DC could not be used as carrier waveform.

To Set the Carrier Phase

After carrier waveform shape is selected, press **Start Phase** to highlight it and use the numeric keyboard or the direction keys and knob to input the desired phase. The phase range is from 0° to 360° and the default is 0°.

To Select the Modulating Waveform Source

BPSK uses internal modulation source. Press **Data Source** to select PN15, PN21, 01 or 10 and the default is PN15.

Explanation:

PN sequence (Pseudo-noise Sequence), a kind of periodic binary sequence, has the statistical characteristics similar to a random noise but can be produced and processed repeatedly. The most commonly used PN sequence is m sequence generated by shift registers with linear feedback and its period is relevant to the linear feedback logic and the initial state of each register. The period of the m sequence generated by n-level shift register is $2^n - 1$. As In the figure below is a 4-level linear feedback shift register of which the feedback logic is $a_3 \oplus a_2$. For PN15 and PN21, 15 and 21 are levels of the registers.

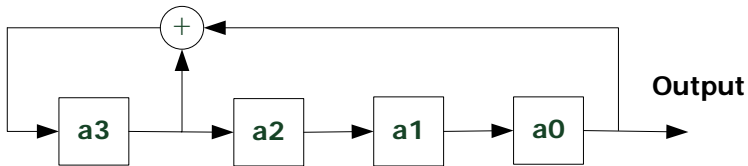

To Set the BPSK Rate

BPSK uses internal modulation source. Press **Rate** to set the frequency at which the output phase shifts between "carrier phase" and "modulating phase".

- Use the numeric keyboard or direction keys and knob to input the desired frequency value.
- The frequency range is from 2mHz to 1MHz and the default is 100Hz.

To Set the BPSK Phase

BPSK phase is the modulating phase. Press **Phase** to set the modulating phase.

- Use the numeric keyboard or direction keys and knob to input the desired phase value.
- The phase range is from 0° to 360° and the default is 180° .

QPSK

When QPSK (Quadrature Phase Shift Keying) is selected, you can configure the generator to "shift" its output phase among four preset phases ("carrier phase" and three "modulating phases"). The "shift" frequency (QPSK rate) is determined by the internal signal level of the instrument.

To Select QPSK Modulation

Press **Mod** → **Type** → **QPSK** to enable QPSK function.

- When **Mod** is enabled, **Sweep** or **Burst** will be automatically disabled (if enabled currently).
- After QPSK is enabled, the instrument will generate QPSK waveform with the currently specified carrier and modulating waveforms.

To Select the Carrier Waveform Shape

QPSK carrier waveform could be Sine, Square, Ramp or arbitrary waveform (except DC), and the default is Sine.

- Press the front panel key **Sine**, **Square**, **Ramp** or **Arb** → **Select Wform** (or **User**, the pre-defined waveform cannot be DC) to select desired carrier waveform shape.
- Pulse (basic waveform), Noise and DC could not be used as carrier waveform.

To Set the Carrier Phase

After carrier waveform shape is selected, press **Start Phase** to highlight it and use the numeric keyboard or direction keys and knob to input the desired phase. The phase range is from 0° to 360° and the default is 0°.

To Select the Modulating Waveform Source

QPSK uses internal modulation source. Press **Data Source** to select PN15 or PN21 and the default is PN15.

To Set the QPSK Rate

QPSK uses internal modulation source. Press **Rate** to set the frequency at which the output phase shifts between "carrier phase" and "modulating phase".

- Use the numeric keyboard or direction keys and knob to input the desired frequency value.
- The frequency range is from 2mHz to 1MHz and the default is 100Hz.

To Set the QPSK Phases

QPSK phases are the modulating phases. Press **Phase1**, **Phase2** and **Phase3** to set the modulating phases respectively.

- Use the numeric keyboard or direction keys and knob to input the desired phase value.
- The phase range is from 0° to 360° and the default values of **Phase1**, **Phase2** and **Phase3** are 450°, 135° and 225° respectively.

3FSK

When 3FSK (3 Frequency Shift Keying) modulation is selected, you can configure the generator to "shift" its output frequency among three preset frequencies ("carrier frequency" and two "modulating frequencies"). The "shift" frequency (3FSK rate) is determined by the internal signal level of the instrument.

To Select 3FSK Modulation

Press **Mod** → **Type** → **3FSK** to enable 3FSK function.

- When **Mod** is enabled, **Sweep** or **Burst** will be automatically disabled (if enabled currently).
- After 3FSK is enabled, the instrument will generate 3FSK waveform with the currently specified carrier and modulating waveforms.

To Select the Carrier Waveform Shape

3FSK carrier waveform could be Sine, Square, Ramp or arbitrary waveform (except DC), and the default is Sine.

- Press the front panel key **Sine**, **Square**, **Ramp** or **Arb** → **Select Wform** (or **User**, the pre-defined waveform cannot be DC) to select desired carrier waveform shape.
- Pulse (basic waveform), Noise and DC could not be used as carrier waveform.

To Set the Carrier Frequency

Different carrier waveforms have different frequency ranges as shown in the table below. For all the carrier waveforms, the default value is 1kHz.

Carrier Waveform	Frequency Range
Sine	1 μ Hz to 160MHz
Square	1 μ Hz to 50MHz
Ramp	1 μ Hz to 4MHz
Arbitrary Waveform	1 μ Hz to 40MHz

After the carrier waveform is selected, you can press **Freq/Period** to highlight "Freq", and then use the numeric keyboard or direction keys and knob to input the desired frequency value.

Modulation Source

3FSK uses internal modulation source and the modulating waveform is Sine.

To Set the 3FSK Rate

3FSK uses internal modulation source. Press **KeyFreq** to set the frequency at which the output frequency shifts between "carrier frequency" and the two "hop frequencies".

- Use the numeric keyboard or direction keys and knob to input the desired frequency value.
- The frequency range is from 2mHz to 1MHz and the default is 100Hz.

To Set the Hop Frequencies

Alternating frequencies ("hop" frequencies) are the modulating frequencies. The ranges of hop frequencies depend on the carrier waveform currently selected. Press **HopFreq1** and **HopFreq2** to highlight them and input the desired frequency values using the numeric keyboard or direction keys and knob respectively.

- Sine: 1 μ Hz to 160MHz
- Square: 1 μ Hz to 50MHz
- Ramp: 1 μ Hz to 4MHz
- Arb: 1 μ Hz to 40MHz

4FSK

When 4FSK (4 Frequency Shift Keying) modulation is selected, you can configure the generator to "shift" its output frequency among four preset frequencies ("carrier frequency" and three "hop frequencies"). The "shift" frequency (4FSK rate) is determined by the internal signal level of the instrument.

To Select 4FSK Modulation

Press **Mod** → **Type** → **4FSK** to enable 4FSK function.

- When **Mod** is enabled, **Sweep** or **Burst** will be automatically disabled (if enabled currently).
- After 4FSK is enabled, the instrument will generate 4FSK waveform with the currently specified carrier and modulating waveforms.

To Select the Carrier Waveform Shape

4FSK carrier waveform could be Sine, Square, Ramp or arbitrary waveform (except DC), and the default is Sine.

- Press the front panel key **Sine**, **Square**, **Ramp** or **Arb** → **Select Wform** (or **User**, the pre-defined waveform cannot be DC) to select the desired carrier waveform shape.
- Pulse (basic waveform), Noise and DC could not be used as carrier waveform.

To Set the Carrier Frequency

Different carrier waveforms have different frequency ranges as shown in the table below. For all the carrier waveforms, the default value is 1kHz.

Carrier Waveform	Frequency Range
Sine	1 μ Hz to 160MHz
Square	1 μ Hz to 50MHz
Ramp	1 μ Hz to 4MHz
Arbitrary Waveform	1 μ Hz to 40MHz

After the carrier waveform is selected, you can press **Freq/Period** to highlight "Freq", and then use the numeric keyboard or direction keys and knob to input the desired frequency value.

Modulation Source

4FSK uses internal modulation source and the modulating waveform is Sine.

To Set the 4FSK Rate

4FSK uses internal modulation source. Press **KeyFreq** to set the frequency at which the output frequency shifts between "carrier frequency" and three "hop frequencies".

- Use the numeric keyboard or direction keys and knob to input the desired frequency value.
- The frequency range is from 2mHz to 1MHz and the default is 100Hz.

To Set the Hop Frequencies

Alternating frequencies ("hop" frequencies) are the modulating frequencies. The ranges of hop frequencies depend on the carrier waveform currently selected. Press **HopFreq1**, **HopFreq2** and **HopFreq3** to highlight them and input the desired frequency values using the numeric keyboard or direction keys and knob respectively.

- Sine: 1 μ Hz to 160MHz
- Square: 1 μ Hz to 50MHz
- Ramp: 1 μ Hz to 4MHz
- Arb: 1 μ Hz to 40MHz

OSK

When OSK (Oscillation Shift Keying) modulation is selected, users can configure the generator to output a sine signal with intermittent oscillation as shown in the figure below (the carrier waveform is 100Hz and the OSK rate is 10kHz). The start-oscillation and stop-oscillation of the internal crystal oscillator are controlled by the internal signal level or signal level at the **[Mod/FSK/Trig]** connector at the rear panel. When the internal crystal oscillator starts to oscillate, the instrument starts to output the carrier waveform and when the internal crystal stops oscillating, the output stops.

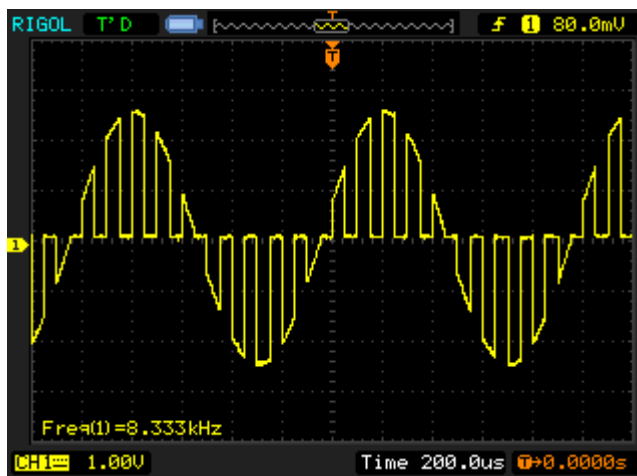

Figure 5-1 OSK Modulated Waveform

To Select OSK Modulation

Press **Mod** → **Type** → **OSK** to enable OSK function.

- When **Sine** is currently selected, OSK in the **Type** is not available.
- When **Mod** is enabled, **Sweep** or **Burst** will be automatically disabled (if enabled currently).
- After OSK is enabled, the instrument will generate OSK waveform with the currently specified carrier and modulating waveforms.

To Select the Carrier Waveform Shape

OSK carrier waveform can only be sine waveform. Press **Sine** at the front panel.

To Set the Carrier Frequency

After carrier waveform shape is selected, press **Freq/Period** to highlight "Freq" and use the numeric keyboard or direction keys and knob to input the desired frequency. The range is from 1 μ Hz to 160MHz.

To Select the Modulating Waveform Source

Press **Mod** → **Source** to select "Int" or "Ext" modulation source.

1. Internal Source

When internal source is selected, the modulating waveform is set as a Square with 50% duty cycle. At this point, the intermittence time and oscillate time of the output signal is determined by the OSK "Rate".

2. External Source

When external source is selected, the generator receives external modulating signal from the **[Mod/FSK/Trig]** connector at the rear panel.



To Set the OSK Rate

When internal source is selected, press **Rate** to set the OSK rate.

- Use the numeric keyboard or direction keys and knob to input the desired frequency value.
- The frequency range is from 2mHz to 1MHz and the default is 1kHz.

To Set the Oscillate Period

Oscillate period is the oscillation period of internal crystal oscillator. The settable range of the oscillate period is related to the OSK rate currently selected. Press **OscTime** to highlight it and use the numeric keyboard or direction keys and knob to input the desired period. The default range is from 8ns to 499.75 μ s.

PWM

A PWM (Pulse Width Modulation) modulated waveform consists of carrier waveform and modulating waveform. The pulse width of the carrier waveform varies with the instantaneous voltage of the modulating waveform.

To Select PWM Modulation

PWM can only be used to modulate pulse. To select PWM modulation, press **Pulse** at the front panel first and then press **Mod** to enable PWM function.

- If the **Pulse** function key has not been selected, PWM in **Type** menu is unavailable.
- When **Mod** is enabled but the modulation type is not PWM, pressing **Pulse** will select PWM automatically.
- When **Mod** is enabled, **Sweep** or **Burst** will be automatically disabled (if enabled currently).
- After PWM is enabled, the instrument will generate PWM waveform with the currently specified carrier and modulating waveforms.

To Select the Carrier Waveform Shape

As mentioned before, PWM can only be used to modulate Pulse. To select Pulse waveform, press **Pulse** at the front panel.

Note: "NPulse" and "PPulse" in **Arb** → **Select Wform** → **BuiltIn** → **Common** cannot be used as the PWM carrier waveform.

To Set the Pulse Width/Duty Cycle

After the carrier waveform shape is selected, press **Width/Duty** to highlight "Width" or "Duty" and input the desired value using the numeric keyboard or direction keys and knob.

To Select the Modulating Waveform Source

Press **Mod** → **Source** to select "Int" or "Ext" modulating waveform source.

1. Internal Source

When internal modulation source is selected, press **Shape** to select Sine, Square, Triangle, UpRamp, DnRamp, Noise or Arb as modulating waveform.

The default is Sine.

- Square: 50% duty cycle.
- Triangle: 50% symmetry.
- UpRamp: 100% symmetry.
- DnRamp: 0% symmetry.
- Arb: when arbitrary waveform is selected as modulating waveform, the generator would limit the waveform length to 2kpts automatically.

Note: Noise can be used as modulating waveform but cannot be used as carrier waveform.

2. External Source

When external modulation source is selected, the **Shape** menu will be grayed out and disabled. The generator receives the external modulating signal from the **[Mod/FSK/Trig]** connector at the rear panel. The "WidthDev" (or "DutyDev") is controlled by the ± 2.5 V signal level of the connector.



To Set the Modulating Waveform Frequency

When internal modulation source is selected, press **PWM Freq** to set the frequency of the modulating waveform.

- Use the numeric keyboard or direction keys and knob to input the desired frequency value.
- The frequency range is from 2mHz to 1MHz and the default is 100Hz.

Note: When "Ext" modulation source is selected, this menu is grayed out and disabled.

To Set the Pulse Width/Duty Cycle Deviation

Press **WidthDev** (or "**DutyDev**") and input the desired value using the numeric keyboard or direction keys and knob.

- Width deviation represents the variation (in seconds) of the modulated waveform pulse width relative to the original pulse width.
Pulse width deviation range: 0s to 500ks.
The width deviation cannot exceed the current pulse width.
The width deviation is limited by the minimum pulse width and current edge time setting.
- Duty cycle deviation represents the variation (in %) of the modulated waveform duty cycle relative to the original pulse duty cycle.
Duty cycle deviation range: 0% to 50%.
The duty cycle deviation cannot exceed the current pulse duty cycle.
The duty cycle is limited by the minimum duty cycle and current edge time setting.

When "Ext" modulation source is selected, width deviation (or duty deviation) is controlled by the $\pm 2.5V$ signal level at the **[Mod/FSK/Trig]** connector at the rear panel. For example, if the width deviation is set to 10s, the +2.5V signal level corresponds to a 10s variation in pulse width.

Chapter 6 Sweep

DG4000 can output sweep from a single channel or from dual channels at the same time. In sweep mode, the generator varies its output from the start frequency to end frequency within the specified sweep time. DG4000 supports linear, log and step sweep modes, allows users to set start hold, end hold and return time, supports internal, external and manual trigger sources and can generate sweep output for Sine, Square, Ramp and arbitrary waveform (except DC).

Subjects in this chapter:

- To Enable Frequency Sweep
- Start Frequency and End Frequency
- Center Frequency and Frequency Span
- Sweep Type
- Sweep Time
- Return Time
- Mark Frequency
- Start Hold
- End Hold
- Sweep Trigger Source
- Trigger Output Edge

To Enable Frequency Sweep

Press **Sweep** at the front panel to enable the sweep function (the backlight of the key goes on), and **Mod** or **Burst** function will be automatically disabled (if currently enabled). The instrument will generate the sweep waveform from the corresponding channel (if currently turned on) according to the current configuration. You can also reset the sweep function menu. Please refer to the introduction in the following text for details.

Start Frequency and End Frequency

Start frequency and end frequency are the upper and lower limits of the frequency for frequency sweep. The generator sweeps from the start frequency to the end frequency and then returns back to the start frequency.

- Start Frequency < End Frequency: the generator sweeps from low frequency to high frequency.
- Start Frequency > End Frequency: the generator sweeps from high frequency to low frequency.
- Start Frequency = End Frequency: the generator outputs with a fixed frequency.

When frequency sweep is enabled, press **Start/Center** to highlight "**Start**". Note that, "**End**" in **End/Span** will also be highlighted. Use the numeric keyboard or direction keys and knob to input the desired frequencies. By default, the start frequency is 100Hz and the end frequency is 1kHz. Different sweep waveform corresponds to different start frequency and end frequency range.

- Sine: 1μHz to 160MHz
- Square: 1μHz to 50MHz
- Ramp: 1μHz to 4MHz
- Arb: 1μHz to 40MHz

The generator will renewedly sweep from the specified "start frequency" after start frequency or end frequency is changed.

Center Frequency and Frequency Span

You can also set the frequency boundaries of frequency sweep through center frequency and frequency span.

- Center Frequency = (|Start Frequency + End Frequency|) / 2
- Frequency Span = End Frequency – Start Frequency

When frequency sweep is enabled, press **Start/Center** to highlight "Center". Notice that, "Span" in **End/Span** will also be highlighted. Use the numeric keyboard or direction keys and knob to enter the desired frequency values. By default, the center frequency is 550Hz and the frequency span is 900Hz.

Different sweep waveform corresponds to different center frequency and frequency span range and center frequency and frequency span are inter-related.

Define the minimum frequency of the waveform currently selected as F_{\min} , the

maximum frequency as F_{\max} and $F_m = (F_{\min} + F_{\max}) / 2$.

- The range of center frequency is from F_{\min} to F_{\max} and the parameters for

different waveforms are as follows:

Sine: 1μHz to 160MHz

Square: 1μHz to 50MHz

Ramp: 1μHz to 4MHz

Arb: 1μHz to 40MHz

- The range of the frequency span is influenced by the center frequency:

Center frequency < F_m : frequency span range is $\pm 2 \times (\text{center frequency} -$

$F_{\min})$;

Center frequency $\geq F_m$: frequency span range is $\pm 2 \times (F_{\max} - \text{center frequency})$.

Take sine as an example. F_{\min} is 1μHz, F_{\max} is 160MHz and F_m is about 80MHz.

If the center frequency is 550Hz, the range of the frequency span is:

$$\pm 2 \times (550\text{Hz} - 1\mu\text{Hz}) = \pm 1.099999998\text{kHz};$$

if the center frequency is 155MHz, the range of the frequency span range is:

$$\pm 2 \times (160\text{MHz} - 155\text{MHz}) = \pm 10\text{MHz}.$$

The generator will renewedly sweep from the specified "Start Frequency" after "Center Frequency" or "Frequency Span" is changed.

Tip

In large-scale sweep, the amplitude characteristic of the output signal might change.

Sweep Type

DG4000 provides three sweep types, including **Linear**, **Log** and **Step**, and the default is **Linear**.

Linear Sweep

The output frequency of the instrument varies linearly in the way of "several Hertz per second". The variation is controlled by "Start Frequency", "End Frequency" and "Sweep Time".

When **Sweep** is enabled, press **Type** to select "Linear". A line is displayed on the waveform on the screen, indicating that the output frequency changes in linear mode.

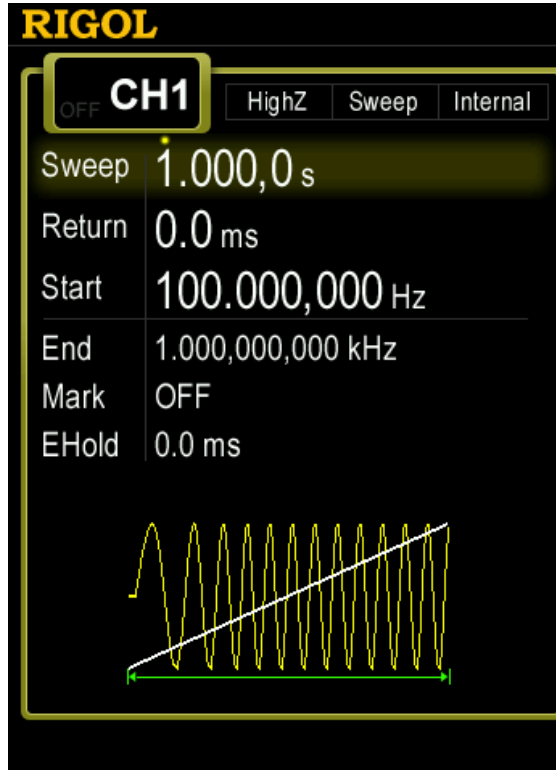

Figure 6-1 Linear Sweep

Log Sweep

The output frequency of the instrument varies in a logarithmic fashion, that is, the output frequency changes in the way of "octave per second" or "decade per second". The change is controlled by "Start Frequency", "End Frequency" and "Sweep Time".

When Log Sweep is enabled, users could set the following parameters:

start frequency (F_{start}), end frequency (F_{stop}) and sweep time (T_{sweep})

The function prototype of log sweep is $F_{current} = P^T$. P and T could be expressed using the above-mentioned parameters.

$$P = 10^{\lg(F_{stop} / F_{start}) / T_{sweep}}$$

$$T = t + \lg(F_{start}) / \lg(P)$$

Wherein, t is the time from the start of the sweep and its range is from 0 to T_{sweep} .

$F_{current}$ is the instantaneous frequency currently output.

When **Sweep** is enabled, press **Type** to select "Log". An exponential function curve is displayed on the waveform on the screen, indicating that the output frequency changes in a logarithmic mode.

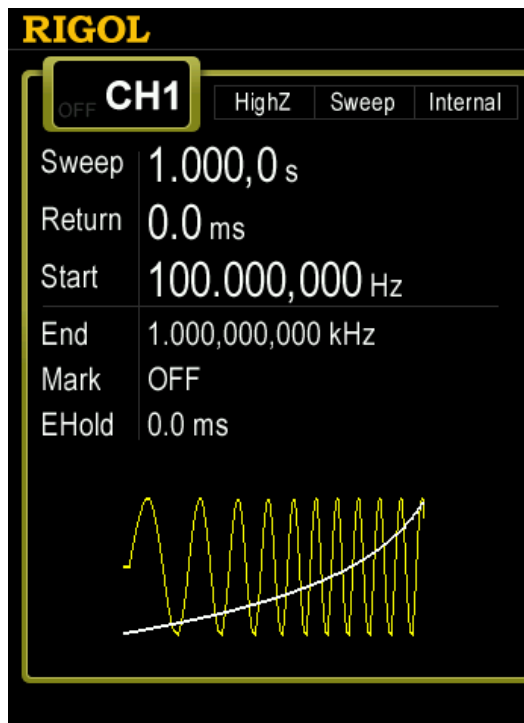



Figure 6-2 Log Sweep

Step Sweep

The output frequency of the instrument "steps" from "Start Frequency" to "End Frequency". The duration of the output signal on each frequency point is

determined by "Sweep Time" and "Step Number".

When **Sweep** is enabled, press **Type** to select "Step". A step waveform is displayed on the waveform on the screen, indicating that the output frequency changes in "steps". At this point, press  to open the 2/2 menu page. Press **StepNum** and use the numeric keyboard or knob to input the step number. The default is 2 and the range is from 2 to 2048. Note: In "Linear" and "Log" sweep modes, **StepNum** is grayed out and disabled.

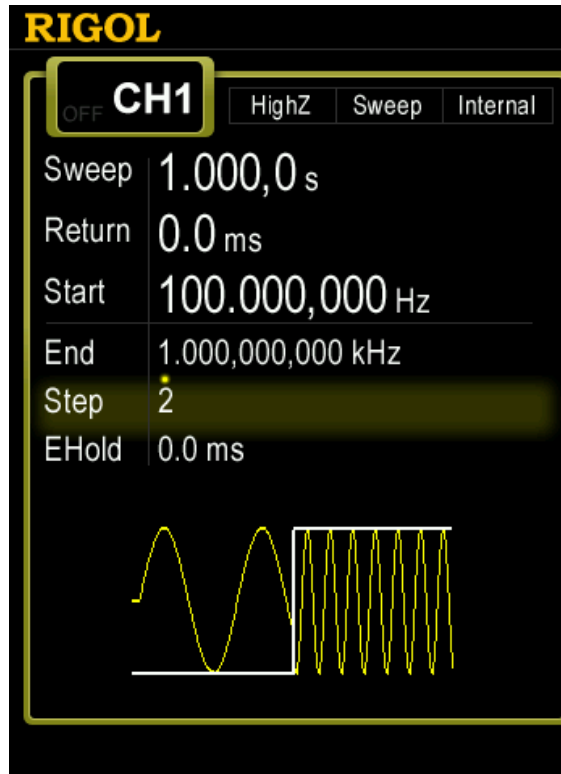

Figure 6-3 Step Sweep

Sweep Time

When **Sweep** is enabled, press **Sweep Time** and use the numeric keyboard or knob to change the sweep time. The default value is 1s and the settable range is from 1ms to 300s. The generator will renewedly sweep and output from the specified "Start Frequency" once the sweep time is changed.

Return Time

The generator will always sweep from the "Start" frequency to the "Stop" frequency and stay within the "Stop Hold" time. Return time describes the time needed for the output signal to return to the "Start" frequency from the "Stop" frequency after the "Stop Hold" time.

When **Sweep** is enabled, press **Return Time** and use the numeric keyboard or the direction keys and knob to change the return time. The default value is 0s and the settable range is from 0s to 300s.

The generator will renewedly sweep from the specified "Start Frequency" once the return time is changed.

Mark Frequency

The sync signal on the **[Sync]** connector at the front panel corresponding to the channel always changes from low-level to high-level at the start of each sweep, and changes from high-level to low-level at the middle of the sweep period when "Mark" function is disabled or at the specified mark frequency point when "Mark" function is enabled.

When **Sweep** is enabled, press **Mark** and select "On", as shown in the figure below, use the numeric keyboard or the direction keys and knob to modify the mark frequency. The default value is 550Hz and the settable range is limited by the "Start" frequency and "Stop" frequency.

The generator will renewedly sweep and output from the specified "Start" frequency once the mark frequency is changed.

Note: In step sweep mode, **Mark** is grayed out and disabled.

Start Hold

Start hold is the period of time that the output signal outputs with the "Start" frequency after the sweep starts. After the start hold time expires, the generator will output with varying frequency in the current sweep type.

When **Sweep** is enabled, use  to open the 2/2 menu page; then, press **Start Hold** and use the numeric keyboard or the direction keys and knob to change the start hold time. The default value is 0s and the settable range is from 0s to 300s.

The generator will renewedly sweep and output from the specified "Start" frequency once the start hold time is changed.

End Hold

End hold is the period of time that the output signal outputs with the "Stop" frequency after the generator has swept from the "Start" frequency to the "Stop" frequency".

When **Sweep** is enabled, use  to open the 2/2 menu page; then, press **End Hold** and use the numeric keyboard or the direction keys and knob to change the end hold time. The default value is 0s and the settable range is from 0s to 300s.

The generator will renewedly sweep and output from the specified "Start" frequency once the end hold time is changed.

Sweep Trigger Source

The sweep trigger source could be internal, external or manual. The generator will generate a sweep output when a trigger signal is received and then wait for the next trigger.

When **Sweep** is enabled, use  to open the 2/2 menu page and press **Source** to select "Int", "Ext" or "Manual". The default is "Int".

1. Internal Trigger

The generator outputs continuous sweep waveform. The trigger period is determined by the specified sweep time, return time, start hold and end hold times.

2. External Trigger

The generator receives the trigger signal input from the **[Mod/FSK/Trig]** connector at the rear panel. A sweep will be generated once the connector gets a TTL pulse with specified polarity. To set the TTL pulse polarity, press **SlopeIn** to select "Leading" or "Trailing". The default is "Leading".

Note: In "Int" and "Manual" trigger modes, the corresponding menu is **TrigOut**. The **[Mod/FSK/Trig]** connector at the rear panel is used as the output terminal of trigger signal.



3. Manual Trigger

A sweep will be generated from the corresponding channel once you press **Trigger1** or **Trigger2** at the front panel.

Trigger Output Edge

In sweep mode, when "Int" or "Manual" trigger source is selected, the generator will output a TTL compatible signal with specified edge from the **[Mod/FSK/Trig]** connector at the rear panel.



- Internal Trigger: the generator outputs a Square waveform with 50% duty cycle from the **[Mod/FSK/Trig]** connector at the beginning of the Sweep. The trigger period depends on the specified sweep time, return time, start hold and end hold.
- Manual Trigger: the generator outputs a Pulse waveform with greater than 1 μ s pulse width at the beginning of the Sweep from the **[Mod/FSK/Trig]** connector.
- External Trigger: the **[Mod/FSK/Trig]** connector is used as the input terminal of external trigger signal and has no trigger output.

When "Int" or "Manual" trigger is selected, press **TrigOut** to set the edge type of the trigger output signal. The default is "Off".

- Off: disable the trigger output signal.
- Leading: output the trigger signal at the rising edge.
- Trailing: output the trigger signal at the falling edge.

Chapter 7 Burst

DG4000 can output waveform with specified number of cycles (called Burst) from a single channel or from dual channels at the same time. DG4000 supports control of burst output by internal, manual or external trigger source; supports three kinds of burst types including N cycle, infinite and gated. The generator can use Sine, Square, Ramp, Pulse, Noise (only for gated burst) or arbitrary waveform (except DC) to generate burst.

Subjects in this chapter:

- To Enable Burst Mode
- Burst Type
- Burst Phase
- Burst Period
- Gated Polarity
- Burst Delay
- Burst Trigger Source
- Trigger Output Edge

To Enable Burst Mode

Press **Burst** at the front panel to enable Burst function (the backlight of the key goes on), and **Mod** or **Sweep** function will be automatically disabled (if currently enabled). The generator will output burst waveform from the corresponding channel (if currently turned on) according to the current configuration. You can also reset the burst function menu. Please refer to the introduction in the following text for details.

Burst Type

DG4000 could output three types of bursts, including **N Cycle**, **Infinite** and **Gated**. The default is **N Cycle**.

Table 7-1 Relations among burst type, trigger source and carrier waveform

Burst Type	Trigger Source	Carrier Waveform
N Cycle	Int/Ext/Manual	Sine/Square/Ramp/Pulse/Arbitrary waveform (except DC)
Infinite	Ext/Manual	Sine/Square/Ramp/Pulse/Arbitrary waveform (except DC)
Gated	Ext	Sine/Square/Ramp/Pulse/Noise/Arbitrary waveform (except DC)

N Cycle Burst

In N Cycle mode, the generator will output waveform with specified number of cycles after receiving trigger signal. Waveform functions that support N cycle burst include Sine, Square, Ramp, Pulse and arbitrary waveform (except DC).

For N cycle burst, "Int", "Ext" or "Manual" trigger source could be used. Besides, users can set the "Start Phase", "Burst Period" (internal trigger), "Delay", "SlopeIn" (external trigger) and "TrigOut" (internal trigger and manual trigger).

When **Burst** is enabled, press **Type** to select "N Cycle". The parameter "Cycles" on the screen is highlighted and could be edited. At this point, use the numeric keyboard or the direction keys and knob to change the number of cycles; the default is 1 and the settable range is from 1 to 1 000 000 (external trigger or manual trigger) or 1 to 500 000 (internal trigger).

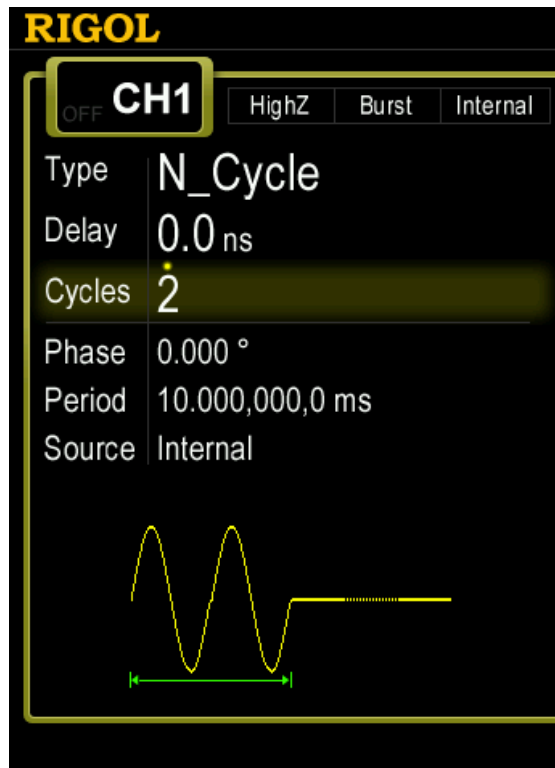

Figure 7-1 N Cycle Burst

Infinite Burst

In Infinite mode, the cycle number of the waveform is set as an infinite value. The generator outputs a continuous waveform after receiving trigger signal. Waveform functions that support infinite burst include Sine, Square, Ramp, Pulse and arbitrary waveform (except DC).

For infinite burst, "Ext" or "Manual" trigger source could be used. Besides, users can set the "Start Phase", "Delay", "SlopeIn" (external trigger) and "TrigOut"

(manual trigger).

When **Burst** is enabled, press **Type** to select "Infinite". A schematic diagram of infinite cycle pulse will be displayed on the screen.



Figure 7-2 Infinite Burst

Gated Burst

In Gated Mode, the generator controls the waveform output according to the external signal level from the **[Mod/FSK/Trig]** connector at the rear panel. Waveform functions which support Gated Burst are Sine, Square, Ramp, Pulse, Noise and arbitrary waveforms (except DC).

When the gated signal is "True", the generator outputs a continuous waveform; when the gated signal is "False", the generator completes the current period, and

then stops and holds on the voltage level corresponding to the initial burst phase of the selected waveform. For Noise waveform, the output will stop immediately once the gated signal becomes "False".

Gated Burst could only be triggered by "Ext" trigger source. Users can also set the "Start Phase".

When **Burst** is enabled, press **Type** to select "Gated" and then press **Polarity** to set the gated polarity as "Pos" (or "Neg"). The generator outputs burst waveform only when the gated signal is "Pos" (or "Neg").

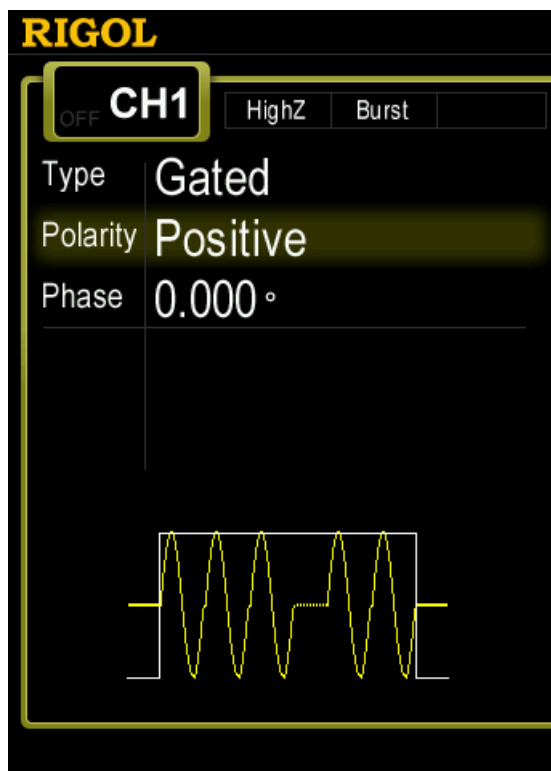

Figure 7-3 Gated Burst

Burst Phase

Burst phase is defined as the phase of the start point of the burst.

When **Burst** is enabled, press **Start Phase** and then use the numeric keyboard or knob to input the desired phase. The default value is 0° and the settable range is from 0° to 360°.

- For Sine, Square, Ramp and Pulse, 0° is the point where the waveform passes through 0V (or DC offset value) positively.
- For arbitrary waveform, 0° is the first point of the waveform.
- For Noise, **Start Phase** is unavailable.

Burst Period

Burst period is only available for N cycle burst in internal trigger and is defined as the time from the start of a burst to the start of the next burst.

- Burst period $\geq 1\mu\text{s} + \text{waveform period} \times \text{number of bursts}$. Here, waveform period is the period of burst function (such as Sine and Square).
- If the burst period is too short, the generator will increase this period automatically to allow the output of the specified number of cycles.

When **Burst** is enabled, press **Type** → "N Cycle" → **Source** → "Int" → **Burst Period** and use the numeric keyboard or the direction keys and knob to input the desired period value. The default is 10ms and the settable range is from 2μs to 500s.

Gated Polarity

Gated polarity is only available in gated burst mode. The instrument outputs burst when the gated signal at the **[Mod/FSK/Trig]** connector at the rear panel is "High Level" or "Low Level".

When **Burst** is enabled, press **Type** → "Gated" → **Polarity** to select "Pos" or "Neg". The default is "Pos".

Burst Delay

Burst delay is only available for N cycle and infinite burst mode. It is defined as the time from when the generator receives the trigger signal to starts to output the N Cycle (or Infinite) burst.

When **Burst** is enabled, press **Type** → "N Cycle" or "Infinite"; then, press  to open the 2/2 menu page and press **Delay**. Use the numeric keyboard or the direction keys and knob to input the desired delay. The delay should be no less than 0s and no greater than 85s. The default is 0s.

Burst Trigger Source

Burst trigger source could be internal, external or manual. The generator will generate a burst output when a trigger signal is received and then wait for the next trigger.

When **Burst** is enabled, press **Source** to select "Int", "Ext" or "Manual". The default setting is "Int".

1. Internal Trigger

When internal trigger is selected, the generator can only output N cycle burst and the burst frequency is determined by the "Burst Period".

2. External Trigger

When external trigger is selected, the generator can output N cycle, infinite or gated burst. The generator receives the trigger signal from the **[Mod/FSK/Trig]** connector at the rear panel. A burst will be generated once the connector receives a TTL pulse with specified polarity. To set the TTL pulse polarity, press **SlopeIn** to select "Leading" or "Trailing" and the default setting is "Leading".

Note: In "Int" trigger and "Manual" trigger, the corresponding menu is **TrigOut**. The **[Mod/FSK/Trig]** connector at the rear panel is used as the

output terminal of trigger signal.



3. Manual Trigger

When manual trigger is selected, the generator can output N cycle or infinite burst. A burst will be generated from the corresponding channel (if currently turned on) once you press **Trigger1** or **Trigger2** at the front panel. If the corresponding channel is not turned on, the trigger will be ignored.

Trigger Output Edge

In burst mode, when the trigger source is "Int" or "Manual", the generator would output a TTL-compatible signal with specified edge from the **[Mod/FSK/Trig]** connector at the rear panel.



- In internal trigger, the generator outputs a square waveform with variable duty cycle (related to the carrier period and number of cycles) from the **[Mod/FSK/Trig]** connector at the start of burst. The trigger period is the same with the specified burst period.
- In manual trigger, the generator outputs a pulse with greater than 1 μ s pulse

width from the **[Mod/FSK/Trig]** connector at the start of burst.

- In external trigger, the **[Mod/FSK/Trig]** connector is used as the input terminal of external trigger signal and has no trigger output.

When "Int" or "Manual" trigger is selected, press **TrigOut** to specify the edge of the trigger output signal and the default is "Off".

- Off: disable the trigger output signal.
- Leading: output the trigger signal at the rising edge.
- Trailing: output the trigger signal at the falling edge.

Chapter 8 Counter

DG4000 provides a 7 digits/s counter which can measure various parameters (such as frequency, period, duty cycle, positive pulse width and negative pulse width) of external input signal and support statistic of measurement results. When the statistic function is enabled, the instrument calculates the maximum, minimum, average and standard deviation of the measurement values automatically and displays the variation tendency of the measurement values in "Digital" or "Curve" mode. In addition, the dual channels can still output normally when the counter is enabled.

Subjects in this chapter:

- To Enable the Counter
- To Set the Counter
- Statistic

To Enable the Counter

Press **Counter** at the front panel (the backlight of the key turns on) to enable counter function and enter counter setting interface as shown in the figure below.

If the counter is currently turned on and the screen displays the counter interface, pressing **Counter** will disable the counter function. If the counter is currently turned on and the screen displays interfaces other than the counter interface, pressing **Counter** will switch to the counter interface.

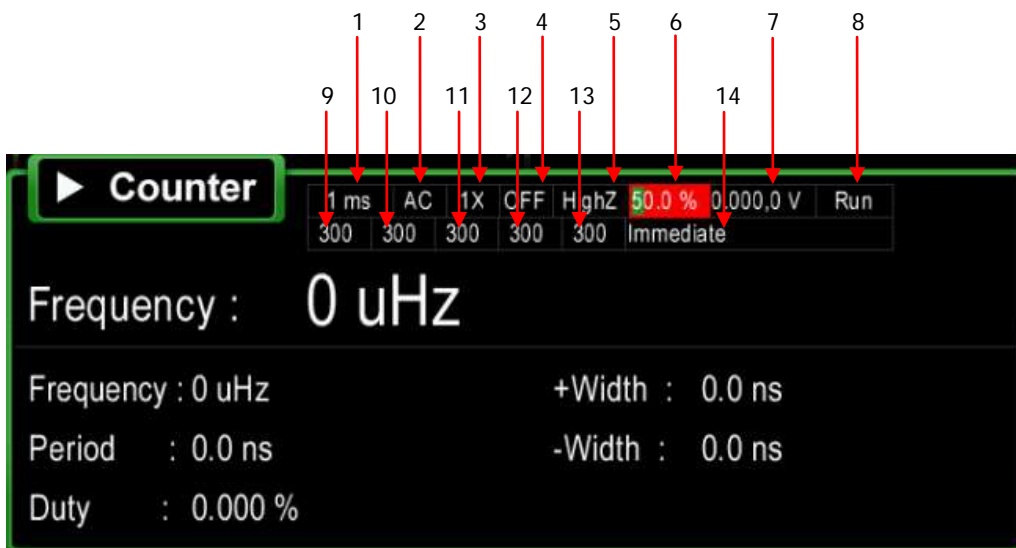

Figure 8-1 Counter Parameter Setting Interface

No.	Description	No.	Description
1	Gate Time	8	Running Status
2	Coupling	9	Statistic Length (Frequency)
3	Attenuation	10	Statistic Length (Period)
4	High-frequency Suppression	11	Statistic Length (Duty Cycle)
5	Input Impedance	12	Statistic Length (Positive Pulse Width)
6	Trigger Sensitivity	13	Statistic Length (Negative Pulse Width)
7	Trigger Level	14	Statistic Trigger Condition

Note: The CH2 sync output will be disabled when the counter is enabled.

To Set the Counter

You need to configure appropriate parameters for the counter.

1. TrigSens

Set the trigger sensitivity of the counter. The default is 50% and the range available is from 0% to 100%.

Press **TrigSens**. Use the numeric keyboard to input the desired value and select the unit "%" from the pop-up menu or use the direction keys and knob to modify the current value.

2. TrigLevel

Set the trigger level of the counter. The system triggers and gets the measurement readings when the input signal reaches the specified trigger level. The default is 0V and the range available is from -2.5V to 2.5V.

Press **TrigLevel**. Use the numeric keyboard to input the desired value and select the desired unit (V or mV) from the pop-up menu or use the direction keys and knob to modify the current value.

3. Imped

Press **Imped** to set the input impedance of the counter to "50 Ohm" or "HighZ" and the default is "HighZ".

4. Coupling

Press **Coupling** to set the coupling mode of the input signal to "AC" or "DC" and the default is "AC".

5. Atten

Press **Atten** to set the attenuation coefficient of the input signal to "X1" or "X10".

6. HFSuppre

High-frequency suppression can be used to filter out the high-frequency components and improve the measurement accuracy in low-frequency signal

measurement.

Press **HFSuppre** to enable or disable the high-frequency suppression function.

Note: Enable the high-frequency suppression function when low-frequency signal with lower than 1kHz frequency is measured to filter out the high-frequency noise interference; disable the high-frequency suppression function when high-frequency signal with greater than 1kHz frequency is measured.

7. Gate Time

Press **Gate Time** to set the gate time of the measurement system and the default is "1 ms".

GateT1	1 ms
GateT2	10 ms
GateT3	100 ms
GateT4	1 s
GateT5	10 s
GateT6	>10 s

8. Select Meas

Press **Select Meas** to select the type of parameter to be measured by the counter. The counter can measure the frequency ("Freq"), period ("Period"), duty cycle ("Duty"), positive pulse width (" +Width") and negative pulse width (" -Width") and the default is "Freq".

9. Statist Set

Press **Statist Set** to set the statistic function of the counter. For the detailed information, please refer to "**Statistic**".

10. Auto

Press **Auto** and the instrument will select a proper gate time automatically according to the characteristics of the signal under test.

11. State

Press **State** to set the running status of the counter to "Run" or "Stop". When you press **Counter** at the front panel, the counter enters the "Run" state automatically and measures the input signal continuously according to the current configuration. When "Stop" is selected, the counter finishes the current measurement and then enters the "Stop" state.

12. Single

Press **Single**; the counter enters the "Single" state; it executes a measurement and then enters the "Stop" state.

Statistic

When the statistic function is turned on, the instrument calculates the maximum, minimum, average and standard deviation of the measurement values automatically and displays the variation tendency of the measurement values in "Digital" or "Curve" mode. Press **Statist Set** to enter the statistic function setting menu.

1. Turn on or off the statistic function

Press **Statist** to turn on or off the statistic function and the default is "Off".

2. Set the statistic parameters

You can set the related information of the statistic parameters when the statistic function is turned off.

Press **Statis Para** to open the statistic parameter setting menu.

- Press **Select Para** to select the type of the parameter of the statistic function. You can select "Freq", "Period", "Duty" "+Width" or "-Width". The default is "Freq".
- Press **Stat En** to turn on or off the statistic function of the statistic parameter.
- Press **Statist Length** to set the statistic length of the statistic parameter currently selected. Use the numeric keyboard to input the desired value and press **OK**, or use the direction keys and knob to modify the current value.
- Press **TrigCond** to set the statistic trigger condition of the statistic parameter. You can select "Imm.", "< Limit" or ">= Limit".
Imm.: start the statistic operation immediately when the statistic function is turned on.
< Limit: start the statistic operation when the measurement value is lower than the preset limit. When "< Limit" is selected, use the numeric keyboard to input the desired value and select the desired unit from the pop-up unit menu or use the direction keys and knob to modify the current value.
>= Limit: start the statistic operation when the measurement value is greater than or equal to the preset limit. When ">= Limit" is selected, use the numeric keyboard to input the desired value and select the desired

unit from the pop-up unit menu or use the direction keys and knob to modify the current value.

- Press **Type** to set the statistic type of the statistic parameter.

Cyclic: restart the statistic operation when the number of statistic operations reaches the specified statistic length.

Stop: stop the statistic operation when the number of statistic operations reaches the specified statistic length.

Note: When the statistic function is turned on, **Statist Para** is grayed out and disabled.

3. Select the measurement mode

Press **Speed** to set the measurement mode of the counter to "Full" or "Normal".

Full: the counter performs measurements exactly according to the specified gate time.

Normal: the counter cannot perform measurements exactly according to the specified gate time due to the effect of the other tasks of the system. Some Measurement values might be lost if the signal under test varies quickly.

4. Select the display mode

After the statistic function is turned on, press **Display** to set the display mode of the statistic results to "Digital" or "Curve", as shown in Figure 8-2 and Figure 8-3.



The screenshot shows the Counter's digital display interface. At the top, there is a 'Counter' label with a play button icon. Below it, a status bar displays various settings: 1 ms, AC, 1X, OFF, HighZ, 50.0 %, 0.000,0 V, and Run. A second row of settings shows 300, 300, 300, 300, 300, and Immediate. The main display area is titled 'Counter Statistics' and contains a table with the following data:

	Freq	Period	Duty	+Width	-Width
Cur	1.0000 kHz	999.9900 us	50.1%	500.8240 us	499.1660 us
Max	1.0001 kHz	1.0001 ms	50.1%	501.2500 us	1.0000 ms
Min	999.9163 Hz	999.9312 us	0.0%	0.0 ns	498.7737 us
Mean	1.0000 kHz	999.9994 us	37.4%	373.9689 us	626.0304 us
SDev	21.6300 mHz	21.6 ns	21.8%	217.8303 us	217.8299 us
Count	75	75	75	75	75

Figure 8-2 Digital Display Interface of the Statistic Results

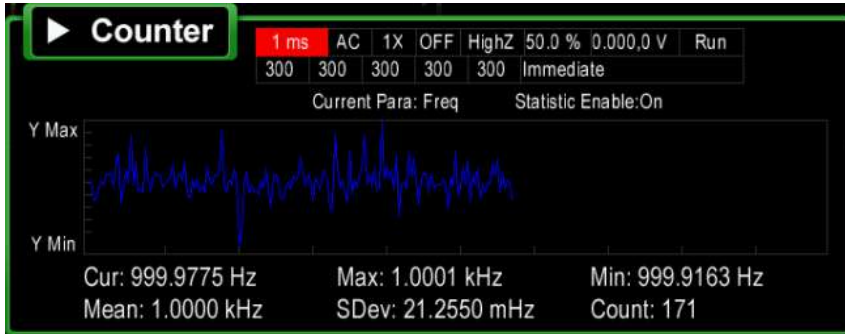

Figure 8-3 Curve Display Interface of the Statistic Results

Note: When the statistic function is turned off, **Display** is grayed out and disabled.

5. Clear the statistic results

When the statistic function is turned on, press **Clear** and the signal generator will clear the current statistic results.

Note: When the statistic function is turned off, **Clear** is grayed out and disabled.

6. Export the statistic data

When there is statistic data and the statistic function is turned off, you can press **Export** to store the statistic data to the USB storage device (only when a USB storage device is detected).

Note: When there is not statistic data or when the statistic function is turned on, **Export** is grayed out and disabled.

Chapter 9 Store and Recall

DG4000 allows users to store the current instrument state and user-defined arbitrary waveform data in the internal or external memory and recall them when needed.

Subjects in this chapter:

- Storage System Overview
- File Type
- Browser Type
- File Operation
- Seamless Interconnection with Oscilloscope

Storage System Overview

DG4000 allows users to store the current instrument state or user-defined arbitrary waveform data in the internal or external memory and recall them when needed.

DG4000 provides an internal non-volatile memory (C Disk) and an external memory (D Disk).

- C Disk: provide 10 storage locations (STATE 1 to STATE 10) for state files and 10 storage locations (ARB 1 to ARB 10) for arbitrary waveform files. Users can store the instrument states and arbitrary waveform files (created by users or downloaded using remote commands) to the C Disk.
- D Disk: available when a USB storage device is detected at the USB Host interface at the front panel.

Users can store the state files or arbitrary waveform files to the D disk as well as copy the files in the C disk to the D disk. The number of files can be stored depends on the storage space of the USB storage device. In addition, users can read the text files and Csv files stored in the USB storage device.

Press **Store** (the key backlight goes on) at the front panel to enable the Store/Recall function and open the Store/Recall interface as shown in the figure below.

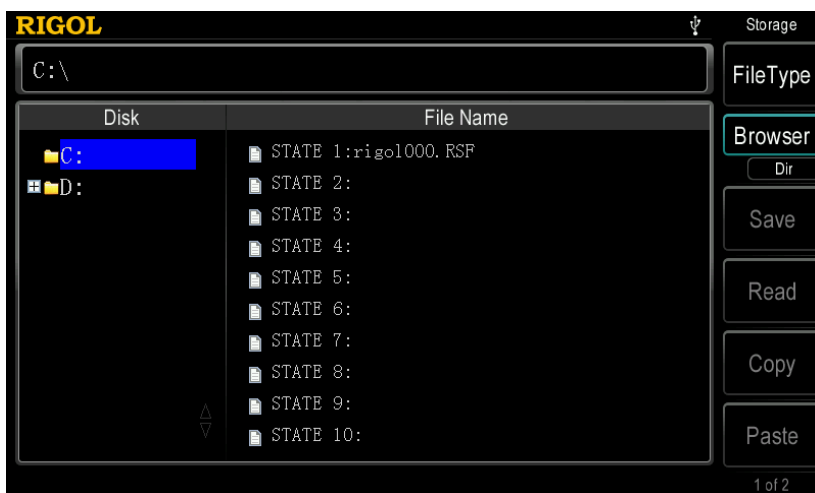

Figure 9-1 Store and Recall Interface

Note: DG4000 can only identify filenames consist of Chinese characters, English letters, number and underscore. If other characters are used to name the file or folder, the name might be displayed in the store and recall interface abnormally.

File Type

Press **Store** → **File Type** to select the desired file type. The file types available include State File, Arb File, Txt File, Csv File and All File.

1. State File

Store the instrument state in the internal or external memory in "*.RSF" format. At most 10 instrument state files can be stored in the internal memory. The 10 instrument state files stored correspond to "User1" to "User10" in **Utility** → **Preset** (refer to "**To Restore the Preset Configuration**").

State storage includes the waveform, frequency, amplitude, DC offset, duty cycle, symmetry and phase as well as the modulation, sweep and burst parameters of the two channels and the counter parameters.

2. Arb File

Store the user-defined arbitrary waveform in the internal or external memory in "*.RAF" format. At most 10 arbitrary waveform files can be stored in the internal memory.

3. Txt File

Read the Txt data files stored in the external memory. The data of each line (cannot exceed 64 characters) is considered as an arbitrary waveform point and the data of all the lines in the file are normalized to form an arbitrary waveform. The arbitrary waveform is stored in the volatile memory. The instrument will enter the arbitrary waveform function interface automatically when the read operation is finished.

Note: This menu is available only when the D disk is selected.

4. Csv File

Read the csv files in external memory. The instrument will enter the **Arb** interface automatically when the "Read" operation is finished. The arbitrary waveform is stored in volatile memory.

Note: This menu is available only when the D disk is selected.

5. All File

Display all the files and folders in the currently selected directory. When this menu is selected, the store function is not available.

Browser Type

Press **Store** → **Browser** to switch between "Dir" and "File". Use the knob to select the desired directory or file.

- Dir: when this type is selected, use the knob to switch between C Disk and D Disk (when USB storage device is inserted).
- File: when this type is selected, use the knob to switch files or folders under the current directory.

File Operation

When "File" is select as the browser type, users can perform a series of operations on files including Save, Read, Copy, Paste, Delete and New Directory.

Save

1. Select the file type

Follow the introduction in "**File Type**" to select the type of the file to be saved. Only state files and arbitrary waveform files can be stored via the instrument.

Note:

- If **File Type** is currently set to "All File", the save operation is unavailable.
- You can also refer to "**To Create an Arbitrary Waveform**" and "**To Edit Arbitrary Waveform**" to save the arbitrary waveform file.

2. Open the filename input interface

In Store/Recall interface, set the **Browser** as "File" and then press **Save** to enter the filename input interface as shown in the figure below.

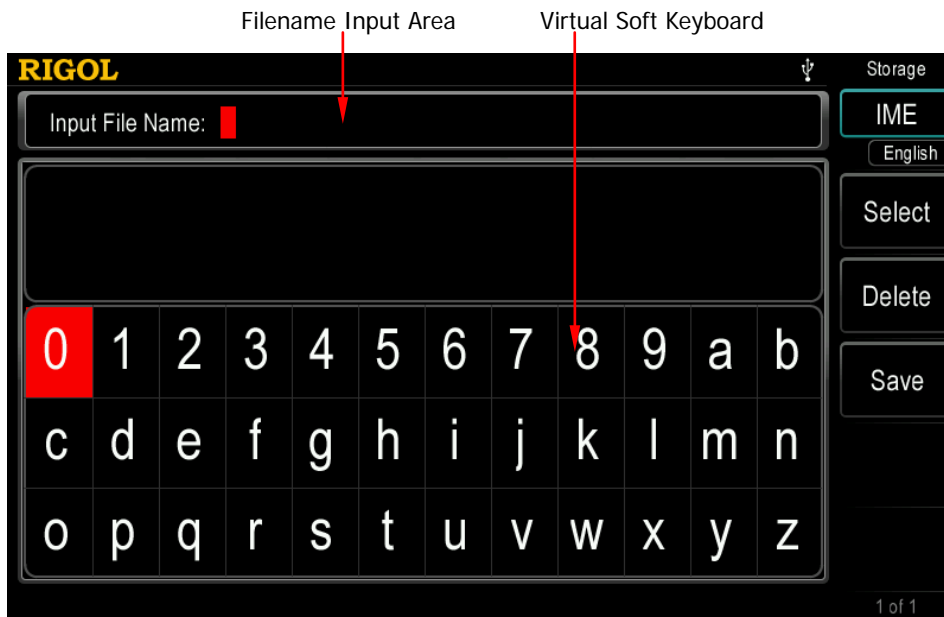

Figure 9-2 Filename Input Interface (English)

3. Input the filename

Press **IME** to select "Chinese" or "English". The length of the file or folder name is limited within 27 characters.

- English Input (include number input):
Press **+/-** on the numeric keyboard to switch between uppercase and lowercase.

Use the knob to select the desired character from the "virtual soft keyboard", then press **Select** to select the character and the character selected would be displayed in the "Filename Input Area". Use the same method to input all the characters needed. You can press **Delete** to delete the character at the cursor currently in the "Filename Input Area".

- Chinese Input:
Press **+/-** on the numeric keyboard to switch to lowercase.

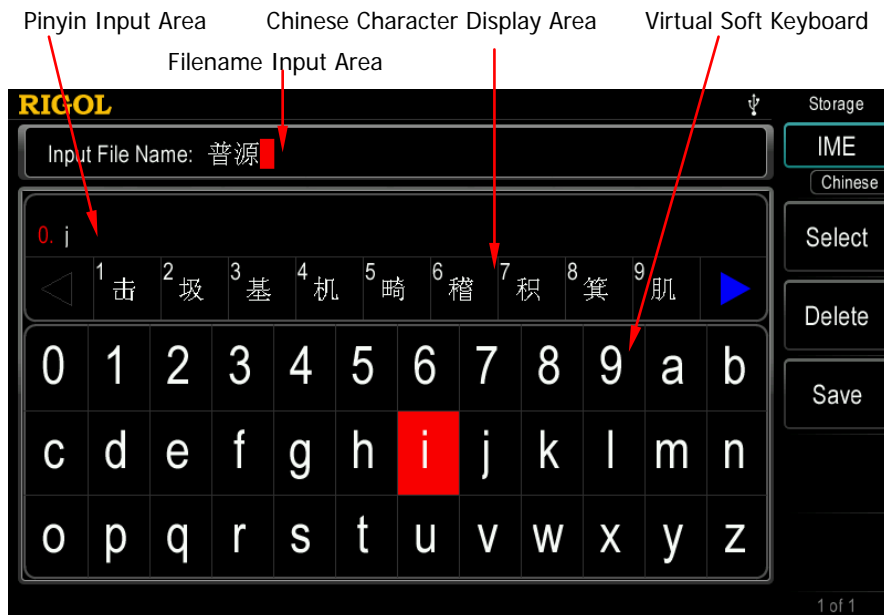

Figure 9-3 Filename Input Interface (Chinese)

Use the knob to select the desired character from the "virtual soft keyboard", then press **Select** to select the character and the character selected would be displayed in the "Pinyin Input Area". After inputting the

pinyin of a Chinese character, use the numeric keyboard to select the No. of the desired Chinese character (if the desired Chinese character is not currently displayed, use the direction key to open the next page) and the Chinese character selected would be displayed in the "Filename Input Area". Use the same method to input all the Chinese characters needed. You can press **Delete** to delete the character in the "Pinyin Input Area" and then the Chinese character at the cursor currently in the "Filename Input Area".

4. Save the file

After finishing inputting filename in the filename input interface, press **Save**, the generator will save the file under the currently selected directory with the specified filename and file type and display corresponding prompt message when the save operation succeeds.

Read

1. Select the file type

Follow the introduction in "**File Type**" to select the type of the file to be read.

Note:

- If **File Type** is currently set to "All File", the file to be read is the file currently selected.
- **Txt File** and **Csv File** are only available when "D:" is currently selected.

2. Select the file to be read

Set **Browser** as "Dir" and use the knob to select the directory in which the file to be recalled is stored. Then set **Browser** as "File", and use the knob to select the file to be recalled.

3. Read the file

Press **Read** and the generator will read the currently selected file and display corresponding prompt message when the read operation succeeds.

Copy and Paste

DG4000 allows users to copy the state file or arbitrary waveform file stored in the internal memory (C disk) to the external memory (USB storage device).

1. Select the file to be copied

Set **Browser** as "Dir" and use the knob to select "C:". Then, set **Browser** as "File" and use the knob to select the file to be copied.

2. Copy the file

Press **Copy** and the generator will copy the file currently selected.

3. Select the paste destination

Set **Browser** as "Dir" and use the knob to select "D:".

4. Paste the file

Press **Paste**; the generator will paste the copied file to the USB storage device and display the corresponding prompt message when the paste operation succeeds.

Delete

1. Select the file or folder to be deleted

Set **Browser** as "Dir" and use the knob to select the directory in which the file or folder to be deleted is stored. Then set **Browser** as "File", and use the knob to select the file or folder to be deleted.

2. Delete the file or folder

Press **Delete** and the generator will delete the currently selected file or folder (empty folder).

New Directory

DG4000 allows users to create new folders in the external memory (USB storage device). Please make sure that a USB storage device is inserted and identified by the instrument.

1. Select the memory

In the store and recall interface, set **Browser** as "Dir" and use the knob to select "D:".

2. Create a new folder

Set **Browser** as "File", use  to open the 2/2 menu page and press **New Folder** to enter the folder name input interface (as shown in Figure 9-2 or Figure 9-3).

Note: When "C:" is selected, this menu is unavailable.

3. Input the folder name

Input the name of the new folder following the introduction in "**Save**".

4. Save the folder

After finishing inputting the new folder name in the folder name input interface, press **Save** and the generator will create a new empty folder under the current directory.

Seamless Interconnection with Oscilloscope

DG4000 can be seamlessly interconnected with **RIGOL** DS1000E, DS6000, MSO/DS4000, MSO/DS2000 and MSO/DS1000Z series digital oscilloscopes to rebuild and output the waveform data sampled by the oscilloscope losslessly. The connection methods between the instruments are as shown in the figure below.

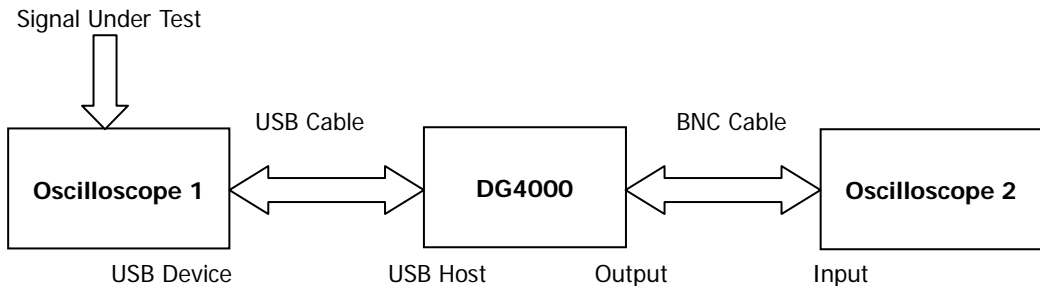

Operation Steps:

1. Display the signal under test on the screen of oscilloscope 1 stably.
2. Connect the USB Host interface of DG4000 with the USB Device interface of oscilloscope 1 using a USB cable. At this point, oscilloscope 1 enters remote mode automatically.
3. Use DG4000 to read the signal under test currently inputted into oscilloscope 1.
 - Press **Store** at the front panel of DG4000 to enter the store and recall interface or press **Arb** → **Select Wform** → **Stored Wforms** at the front panel of DG4000 to enter the store and recall interface. At this point, the model identifier of oscilloscope 1 is displayed in the "Directory Display Area".
 - Set **Browser** of DG4000 as "Dir" and use the knob to move the cursor onto the model identifier of oscilloscope 1. At this point, all the channels and the on/off status of each channel of oscilloscope 1 are displayed in the "File/Folder Display Area" of DG4000.
 - Set **Browser** of DG4000 as "File" and move the cursor to the desired channel; then press **Read**. At this point, oscilloscope 1 enters the stop state automatically. DG4000 will automatically switch to the arbitrary

waveform (**Arb**) mode (if DG4000 is not currently in the arbitrary waveform mode) and read the waveform displayed on the screen (when **DataSel** is set to "Screen") or stored in the internal memory (when **DataSel** is set to "Ram") of oscilloscope 1 to its internal volatile memory.

Note: When **DataSel** is set to "Ram", **DataPos** becomes available. At this point, you can press **DataPos** to select "Head", "TrigPos" or "Tail" to set the position for reading the data in the internal memory of the oscilloscope.

- Head: read from the start position of the data in the internal memory of the oscilloscope.
- TrigPos: read from the trigger position of the data in the internal memory of the oscilloscope.
- Tail: read from the end position of the data in the internal memory of the oscilloscope.

In addition, while reading the waveform of the oscilloscope, to protect the circuit under test, the output of DG4000 will be turned off automatically. Turn on the channel output of DG4000 to output the waveform displayed on the screen or stored in the internal memory of oscilloscope 1 when you are sure that the current output will not damage the device under test.

4. Connect the output terminal of DG4000 with the input terminal of oscilloscope 2 using a BNC cable. Turn on the channel output of DG4000 to output the waveform displayed on the screen or stored in the internal memory of oscilloscope 1. Set oscilloscope 2 and you can view the waveform displayed on the screen or stored in the internal memory of oscilloscope 1 via oscilloscope 2.

Tip: The waveform data sampled by the oscilloscope is stored circularly, thus the waveform data read by DG4000 is also finite and exists discontinuousness in phase. We recommend that you display the desired segment of the signal under test on the oscilloscope screen stably; then, use DG4000 to read the data and output the data through burst (**Burst**) mode.

Chapter 10 Utility Functions and System Settings

DG4000 allows users to configure the parameters of dual channels, configure remote interfaces and set system parameters.

Subjects in this chapter:

- Overview
- Channel Setting
- To Set the System Language
- To Configure the Remote Interface
- System Setting
- Print
- Test/Cal
- Channel Coupling
- Channel Copy
- User-defined Waveform Key
- To Restore the Preset Configuration
- To Use the External Power Amplifier (Option)
- To Lock the Keys

Overview

Press **Utility** at the front panel to open the operation interface as shown in the figure below. This interface displays the current channel output configuration, channel coupling configuration and system parameters.

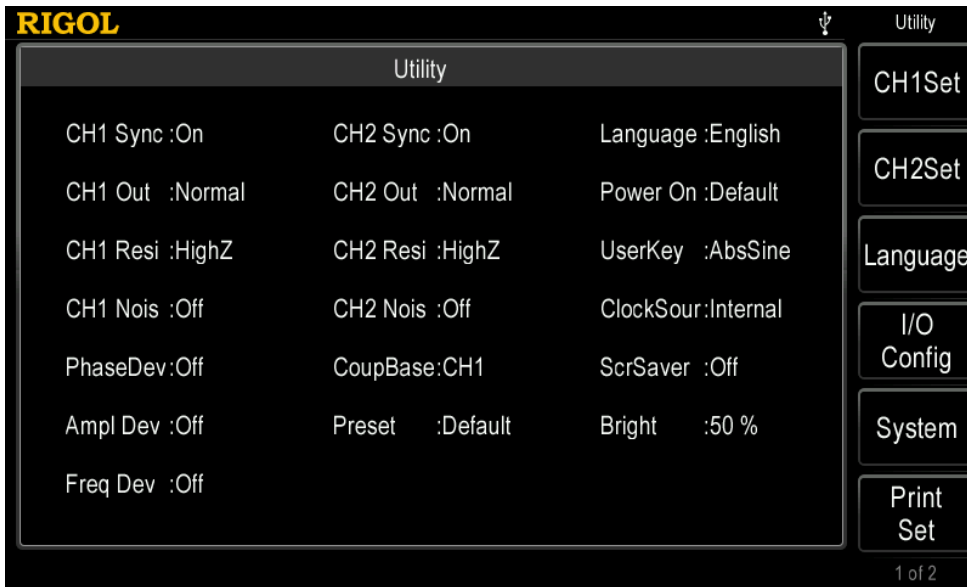

Figure 10-1 Utility Interface

1. **CH1Set**: set the output parameters of CH1.
2. **CH2Set**: set the output parameters of CH2.
3. **Language**: set the language type.
4. **I/O Config**: set the remote control interface parameters.
5. **System**: set the system parameters.
6. **Print Set**: set parameters related to screen print.
7. **Test/Cal**: calibrate DG4000 manually.
8. **Coupling Set**: set the channel coupling parameters.
9. **Channel Copy**: set the channel copy parameters.
10. **UserKey**: define the shortcut keys of the commonly used built-in waveforms.
11. **Preset**: restore the generator to its factory default state or stored states.
12. **PA Set**: set the external power amplifier parameters (only available when the external power amplifier is connected).

Channel Setting

This section takes CH1 for example to illustrate how to set the channel. The setting method for CH2 is quite the same.

Sync

DG4000 could output the sync signals of basic waveforms (except Noise), arbitrary waveforms (except DC), Harmonics, Sweep signal, Burst signal and modulated signal from a single channel or two channels at the same time. The sync signal is output from the **[Sync]** connector at the front panel.

1. Sync On/Off

Enable or disable sync signal at the **[Sync]** connector. Press **Utility** → **CH1Set** → **Sync** to select "On" or "Off" for the sync signal output. The default is "On", namely transmitting the sync signal to the **[Sync]** connector. If sync signal is disabled, the output level at the **[Sync]** connector is logic low.

2. Sync Signals of Various Waveforms

- For Sine, Square, Ramp and Pulse, the sync signal is a Square with 50% duty cycle. It is TTL high level relative to 0V (or DC offset) when the output is positive and TTL low level relative to 0V (or DC offset) when the output is negative.
- For arbitrary waveform, the sync signal is a square with variable duty cycle. The sync signal is TTL high level when the amplitude of the output waveform reaches certain value.
- For harmonics, sync signal is a square with variable duty cycle and takes the harmonic order as reference.
- For AM, FM, PM and PWM, in internal modulation mode, the sync signal is a Square with 50% duty cycle and takes modulating frequency as reference. It is TTL high level in the first half period of the modulation waveform. In external modulation mode, there is no sync signal output.
- For ASK, FSK, PSK, BPSK, QPSK, 3FSK and 4FSK, the sync signal takes ASK/FSK/PSK/BPSK/QPSK/3FSK/4FSK Rate as reference and is a Square

with 50% duty cycle. For ASK, FSK and PSK, in external modulation mode, there is no sync signal output.

- For OSK, the sync signal is a square with 50% duty cycle and takes OSK rate as reference. The sync signal is TTL high level when the internal crystal oscillator starts to oscillate. In external modulation mode, there is no sync signal output.
- For Sweep, when "Mark" is disabled, the sync signal is a Square with 50% duty cycle. It is TTL high level at the start of the sweep and changes to TTL low level at mid-point of the Sweep and its frequency corresponds to the specified sweep time, return time, start hold and end hold times. When "Mark" is enabled, the sync signal is TTL high level when sweep starts and transforms to TTL low level at the marked frequency point.
- For a N cycle burst, the sync signal is TTL high level when burst starts and transforms to TTL low level while the specified number of cycles end (if the waveform has a relative start phase, the crossing point may not be zero). For an infinite burst, its sync signal is the same as the sync signal of a continuous waveform.
- For an external Gated burst, its sync signal follows its gated signal. Note that the sync signal will not transform to TTL low level until the last period is finished (if the waveform has a relative start phase, the crossing point may not be zero).

Sync Polarity

Set the sync signal on the **[Sync]** connector as normal or inverted.

Press **Utility** → **CH1Set** → **Polarity** to select "Pos" or "Neg".

- Pos: output normal sync signal.
- Neg: output inverted sync signal.

Note: The sync signal related to the waveform is not inverted even when the waveform is inverted.

Sync Mode

Set the output mode of the sync signal on the **[Sync]** connector at the front panel to normal or carrier.

Press **Utility** → **CH1Set** → **SyncMode** to select "Normal" or "Carrier".

- Normal: there are default operations for the **[Sync]** output. The operations differ for different operation modes.
- Carrier: only available in basic waveform mode (except noise and DC) and infinite Burst mode. When the sync polarity is positive, **[Sync]** output is high level within the first half of the period and is low level within the second half of the period. When the sync polarity is negative, the **[Sync]** output is reverse to that when the sync polarity is positive.

Output Polarity

Set the signal on the **[Output1]** connector as normal or inverted. Waveform inverts relatively to the offset voltage.

Press **Utility** → **CH1Set** → **Output** to select "Normal" or "Invert". The default is "Normal". In normal mode, the waveform is output normally; in invert mode, the waveform is inverted and then output.

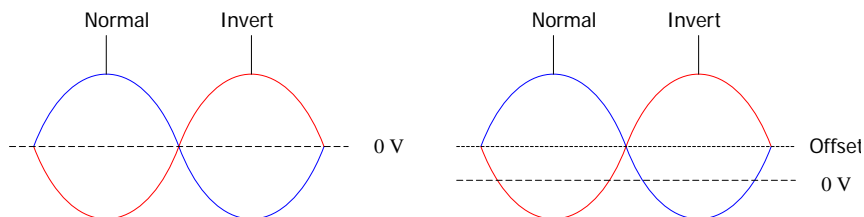

Pay attention to the following contents after the waveform is inverted:

- None of the offset voltage would change.
- Waveform is not inverted in graphic mode.
- Sync signal related to the waveform is not inverted.

Impedance

The impedance setting is applicable to output amplitude and DC offset voltage. DG4000 has a 50Ω fixed serial output impedance for the **[Output1]** connector at the front panel. If the actual load does not match the specified value, the voltage level displayed would not match the voltage level of the component under test. To ensure correct voltage level, the load impedance setting must match the actual load.

Press **Utility** → **CH1Set** → **Imped** to select "HighZ" or "Load". The default is "HighZ". If "Load" is selected, use the numeric keyboard or the direction keys and knob to set a specific impedance value. The default is 50Ω and the settable range is from 1Ω to 10kΩ. The impedance setting will be displayed on the screen. As shown in the figure below, the impedance of CH1 is set to a specified value "50 Ω" and the impedance of CH2 is set to "HighZ".



Figure 10-2 Impedance Setting

The generator will adjust the output amplitude and offset voltage automatically once the impedance setting is changed. For example, the current amplitude is 5Vpp. At this point, change the output impedance from 50Ω to HighZ and the amplitude displayed on the screen will double to 10Vpp. If the output impedance is changed from HighZ to 50Ω, the amplitude will reduce to half of the previous value (2.5Vpp).

Note: Only the displayed values change with the parameter and the real output from the generator does not change.

Noise Superimposition

DG4000 supports to superimpose a gauss noise onto its output signal. This function is called noise superimposition. The signal superimposed with noise can be used to test the anti-noise capability of the instrument.

Press **Utility** → **CH1Set** → **NoiseSum** to turn on or off the noise superimposition function. The default is "Off". When this function is "On", you can use the numeric keyboard or the direction keys and knob to set the noise ratio; the settable range is from 0% to 50% and the default is 10.0%. When Mod, Sweep or Burst is enabled, this menu is grayed out and disabled.

Range

Press **Utility** → **CH1Set** → **Range** and select "Auto" or "Hold". The default is "Auto".

- Auto: the signal generator selects the optimum settings for the output amplifier and attenuator.
- Hold: disable the auto optimization to eliminate the waveform discontinuity caused by the on/off of the relay when the amplitude is modified; while, the amplitude range might be affected.

DDS Hold

Press **Utility** → **CH1Set** → **DDS Hold** and select "On" or "Off". The default is "Off".

When the "DDS Hold" of CH1 and CH2 are both set to "On" and the instrument is not powered off, the two channels will always be in the align phase state (at this point, the align phase state of the two channels will not be affected when you turn on or off the output of any of the two channels) after an align phase operation is executed. When only the "DDS Hold" of CH1 (or CH2) is turned on and the

instrument is not powered off, the two channels will always be in the align phase state (at this point, the align phase state of the two channels will not be affected when you turn on or off the output of CH1 (or CH2)) after an align phase operation is executed when the output of CH2 (or CH1) is not turned off.

To Set the System Language

DG4000 supports menus in various languages as well as provides Chinese and English help information, prompt messages and interface display.

Press **Utility** → **Language** to select the desired language type. When "简体中文" or "English" is selected, the menus, help information, prompt messages and interfaces are displayed in simplified Chinese or English. When another language is selected, only the menus are displayed in the corresponding language; the other information is displayed in English.

This setting is stored in the non-volatile memory and will not be affected by "Preset".

To Configure the Remote Interface

DG4000 is configured with USB and LAN interfaces and supports users to configure the interface parameters for remote communication.

Press **Utility** → **I/O Config** to open the I/O setting menu and set the LAN interface parameters for remote communication or select the type of device connected to the USB interface.

LAN Setting

Press **Utility** → **I/O Config** → **LAN** to open the LAN parameters configuration interface as shown in the following figure. Users can examine network status and configure network parameters.

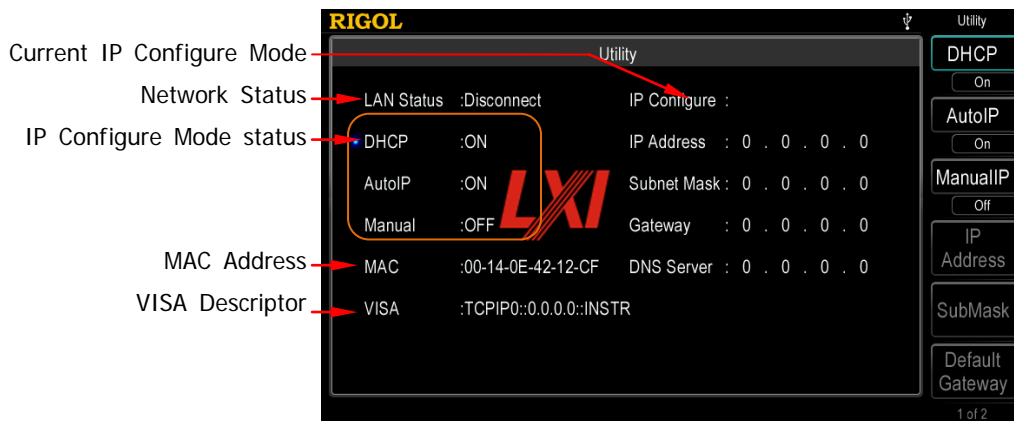

Figure 10-3 LAN Setting Interface

Network Status

Different prompt messages will be provided by the generator based on the current network status.

- Configured
- Disconnect
- Initializing
- IP Conflict
- DHCP Failed

MAC Address

MAC (Media Access Control) address, also called hardware address, is used for defining the position of the network device. For a generator, the MAC address is always unique. It is always used to identify the instrument while assigning IP address for instrument. MAC address (48 bits, namely 6 bytes) is usually expressed in hexadecimal format, such as 00-14-0E-42-12-CF.

VISA Descriptor

VISA (Virtual Instrument Software Architecture) is an advanced application programming interface developed by NI (National Instrument) for communications with various instrument buses. It uses the same method to communicate with instruments regardless of the types of the instrument interfaces (GPIB, USB, LAN/Ethernet or RS232). The GPIB, USB, LAN/Ethernet or RS232 instrument is called "resource".

VISA descriptor is the resource name and describes the accurate name and location of the VISA resource. If LAN interface is currently used for communication with the instrument, the VISA descriptor is TCPIP0::172.16.2.13::INSTR.

IP Configure Mode

IP configure mode could be DHCP, Auto IP or Manual. If the network is disconnected currently, there will be nothing to display behind "IP Configure Mode:". In different IP configuration modes, the configuration modes of network parameters (such as IP address) are different.

1. DHCP

- In DHCP mode, DHCP server in the current network assigns LAN parameters, e.g. IP address, for the generator.
- Press **DHCP** to select "On" or "Off" to turn DHCP mode on or off.

2. Auto IP

- In AutoIP mode, the generator acquires IP address within 169.254.0.1 and 169.254.255.254 and subnet mask 255.255.0.0 automatically according to the current network configuration.
- Press **Auto IP** to select "On" or "Off" to turn Auto IP mode on or off. When the DHCP mode and Auto IP mode are turned on at the same time, the instrument will use the DHCP mode; therefore, to enable this mode, set **DHCP** to "Off".

3. Manual

- In Manual mode, the LAN parameters of the generator, e.g. IP address, are defined by users.
- Press **Manual** to select "On" or "Off" to turn Manual mode on or off. When all the three IP configuration modes are "On", the priority of parameters configuration from high to low is "DHCP", "Auto IP" and "Manual"; therefore, to enable this mode, set **DHCP** and **Auto IP** to "Off".
- The IP address format is nnn.nnn.nnn.nnn. The first nnn ranges from 1 to 223 (except 127) and the other three nnn range from 0 to 255. It is recommended that users acquire an available IP from their network administrator.
- Press **IP Addr** and use the numeric keyboard and direction keys to enter your desired IP. The setting is stored in the non-volatile memory and will be loaded automatically when the generator is powered on the next time if **DHCP** and **Auto IP** are set to "Off".

Tips

- If all the three IP configuration modes are "On", the priority of parameters configuration from high to low is "DHCP", "AutoIP" and "ManualIP".
- The three IP configuration modes cannot be set as "Off" at the same time.

To Set the Subnet Mask

In Manual mode, the subnet mask could be manually set.

- The format of subnet mask is nnn.nnn.nnn.nnn, where nnn ranges from 0 to 255. It is recommended that users acquire an available subnet mask from their network administrator.
- Press **SubMask** and use the numeric keyboard and direction keys to enter your desired subnet mask. The setting is stored in non-volatile memory and will be automatically loaded when the generator is powered on the next time if **DHCP** and **Auto IP** are set to "Off".

To Set the Default Gateway

In Manual mode, the default gateway could be manually set.

- The format of default gateway is nnn.nnn.nnn.nnn, where the first nnn ranges from 1 to 223 (except 127) and the other three nnn range from 0 to 255. It is recommended that users acquire an available default gateway from their network administrator.
- Press **Default Gateway** and use the numeric keyboard and direction keys to enter your desired gateway address. The setting is stored in non-volatile memory and will be automatically loaded when the generator is powered on the next time if **DHCP** and **Auto IP** are set to "Off".

To Set the Domain Name Server (DNS)

In ManualIP mode, the DNS could be manually set.

- The DNS format is nnn.nnn.nnn.nnn, where the first nnn ranges from 1 to 223 (except 127) and the other three nnn range from 0 to 255. It is recommended that users acquire an available DNS address from their network administrator.
- Press **DNS Service** and use the numeric keyboard and direction keys to enter your desired DNS address. The setting is stored in non-volatile memory and will be automatically loaded when the generator is powered on the next time if **DHCP** and **Auto IP** are set as "Off".

Default Configuration

Press **Default Config** and the prompt message "Restore network settings to preset values of LXI?" is displayed. Press **OK** to restore the network parameters to their default values. By default, DHCP and Auto IP are enabled and Manual is disabled.

Current Configuration

Press **Current Config** to examine the MAC address of the current instrument, the current LAN parameters and LAN status information.

Apply

Press **Apply** and the current settings of the LAN parameters will take effect.

To Set the USB Device Type

The USB Device interface at DG4000 rear panel could be connected with PC or PictBridge printer to control the instrument remotely or to print the contents displayed on the screen.

Press **Utility** → **I/O Config** → **USB Dev**:

- Select "PC": users can use PC software to edit arbitrary waveform and download it to the internal memory of the generator. Users can also use the SCPI commands to control the generator.
- Select "Printer": press **Utility** → **Print Set** → **Dest** to select "Printer". Users can press **Print** to print the contents currently displayed in the interface.

System Setting

Number Format

You can set the display formats of the decimal point and thousands separator in number parameters. This setting is stored in non-volatile memory. Press **Utility** → **System** → **Number Format** to enter the number format setting interface.

- Decimal Point: could be set as dot "." or comma "," and the default is dot ".".
- Separator: when the decimal point is set to ".", the separator can be set to ",", "Space" or "None".
When the decimal point is set to ",", the separator can be set to ".", "Space" or "None".

Number format has 6 combinations, as shown in the figure below.

Freq 1.000,000,000 kHz	Dot + Comma
Freq 1.000 000 000 kHz	Dot + Space
Freq 1.000000000 kHz	Dot + None
Freq 1,000.000.000 kHz	Comma + Dot
Freq 1,000 000 000 kHz	Comma + Space
Freq 1,000000000 kHz	Comma + None

Note: The decimal point and separator cannot be both set as dot or comma at the same time.

Power On Setting

Set the configuration to be used when the instrument is powered on the next time to "Default" or "Last". The default setting is "Default".

- Last: include all the system parameters, except output configuration, clock source.
- Default: denote the factory default except some parameters (such as: Language).

Press **Utility** → **System** → **PowerOn** to select the desired configuration type. This setting is stored in non-volatile memory and will not be influenced by "Preset".

Power Setting

Set the start-up mode after the generator is powered on to "Auto" or "Manual" and the default is "Auto".

- Auto: the instrument starts automatically after power-on.
- Manual: users need to press the power switch at the front panel to start the instrument after power-on.

Press **Utility** → **System** → **PowerSet** to select the desired type.

Clock Source

DG4000 provides an internal 10MHz clock source and can receive the external clock source from the **[10MHz In/Out]** connector at the rear panel. It can also output the internal clock source from the **[10MHz In/Out]** connector for other devices.

Press **Utility** → **System** → **Clk Src** to select "Int" or "Ext". The default is "Int". If "Ext" is selected, the instrument will detect whether a valid external clock signal is input from the **[10MHz Out/In]** connector at the rear panel. If no valid clock

source is detected, the prompt message "Not detect a valid external clock!" would be displayed and the clock source would be switched to "Int".

Users can also synchronize two or more instruments by setting the clock source. When two instruments are synchronized, the "Align Phase" function cannot be used. The "Align phase" function can only be used to adjust the phase relation between two output channels of the same instrument and cannot be used to change the phase relation between the output channels of two instruments. Users can change the phase relation between two instruments by change the "Start Phase" of each channel.

Sync methods for two or more instruments:

- Synchronization between two instruments:
Connect the **[10MHz In/Out]** connector of Generator A (set the clock source to "Int") to the **[10MHz In/Out]** connector of Generator B (set the clock source to "Ext") and set the output frequencies of the two instruments as a same value to realize the synchronization between the two instruments.
- Synchronization among multi-instruments:
Divide the 10MHz clock source of a generator (set the clock source to "Int") into multiple paths; then, connect them to the **[10MHz In/Out]** connectors of the other generators (set the clock source to "Ext") respectively. Finally, set the output frequencies of all the generators as a same value to realize the synchronization among multi-instruments.

Brightness

Press **Utility** → **System** → **Bright** and use the numeric keyboard or knob to set the brightness of the screen. The range is from 1% to 100%. This setting is stored in non-volatile memory and will not be influenced by "Preset".

Beeper

When the beeper in DG4000 is turned, the beeper sounds when users operate the front panel or when an error occurs during remote control.

Press **Utility** → **System** → **Beeper** to select "On" or "Off" and the default is "On". The current setting is stored in non-volatile memory and will not be influenced by "Preset".

Screen Saver

Enable or disable screen saver mode.

Press **Utility** → **System** → **ScrnSvr** to select "On" or "Off" and the default is "Off". The current setting is stored in non-volatile memory and will not be influenced by "Preset".

System Information

Press **Utility** → **System** → **System Info** and you can view the information (such as the model, serial number and version number) of the instrument in the system information interface.

Print

Users could store the contents displayed on the screen into external USB storage device in picture format or print them via PictBridge printer. Press **Utility** → **Print Set** to open the print setting interface.

1. Print the screen using PictBridge printer

First, connect the pictBridge printer. Connect the USB Device interface of the signal generator to the USB Host interface of the Printer using USB cable (as shown in the figure below).

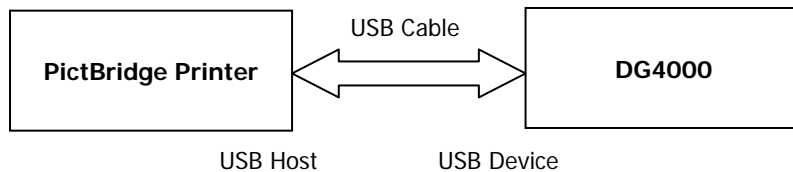

Press **Utility** → **I/O Config** → **USB Dev** to set the device type to "Printer". Press **Utility** → **Print Set** → **Dest** to select "Printer". Then, press **Printer Set** to enter the print setting menu.

- **Copies:** press this softkey and use the knob to input the number of copies to be printed. The range is from 1 to 1000.
- **Palette:** press this softkey to set the color of the image to "Gray" or "Color".
- **Inverted:** press this softkey to enable or disable inverted print.

2. Store the screen to USB Storage Device

Please connect a USB storage device first. When the connection succeeds, an  icon will be displayed in the status bar on the screen and the corresponding prompt message will be displayed.

Press **Utility** → **Print Set** → **Dest** to select "UsbDisk" and then press **Format** to set to store the screen picture in "Bmp" or "Jpeg" format.

3. Execute the print operation

Press **Print** at the front panel and the generator will print the screen via the PictBridge printer or store the screen in the folder named as "Rigol" (if this

folder does not currently exist, it will be created automatically) in the USB storage device in picture format according to the preset configuration.

Note: If no PictBridge printer is currently connected to the generator or no USB storage device is detected, the print operation would fail and the prompt message "PictBridge equipment is not connected." or "USB flash driver not detected. Print invalid." would be displayed.

Test/Cal

Press **Utility** at the front panel, use  to select the 2/2 page menu and press **Test/Cal** to open the Test/Cal interface. You can calibrate DG4000 manually after inputting the correct calibration password.

1. Secure Code

Press this key and use the numeric keyboard to enter the correct calibration password.

2. Secure

By default, this menu is "On". You can only set it to "Off" after you input the correct calibration password. When it is set to "Off", the instrument security mode is turned off.

3. Manual Cal

This menu is available only when **Secure** is set to "Off". At this point, you can perform manual calibration.

4. Preset

This menu is available only when **Secure** is set to "Off". Pressing this softkey can restore the calibration values to their factory default values.

Note: Manual calibration by users is not recommended. If calibration is required, please contact **RIGOL**.

Channel Coupling

DG4000 supports to enable frequency, phase and amplitude couplings separately or at the same time. When coupling is enabled, set CH1 or CH2 as the "base" channel and set the frequency, phase or amplitude deviation of the two channels. Then when the frequency, phase or amplitude of the base channel is changed, the corresponding parameter of the other channel will change automatically and always keeps the specified frequency, phase or amplitude deviation.

Press **Utility** at the front panel, use  to open the 2/2 menu page and press **Coupling Set** to enter the channel coupling setting interface.

1. Set the coupling base

Press **Cpl Base** to set "CH1" or "CH2" as the coupling base. Here, "CH2" is selected.

Note: The coupling base cannot be changed when the coupling function is enabled. At this point, **Cpl Base** is grayed out and disabled.

2. Turn on the Coupling Function

Press **Coupling** to turn "On" or "Off" the frequency, phase and amplitude coupling functions at the same time. The default is "Off".

Press **FreqCpl** to turn frequency coupling "On" or "Off". When frequency coupling is turned on, use the numeric keyboard or the direction keys and knob to input the desired frequency deviation. Here, it is set to "100Hz".

Press **PhaseCpl** to turn phase coupling "On" or "Off". When phase coupling is turned on, use the numeric keyboard or the direction keys and knob to input the desired phase deviation. Here, it is set to "10°".

Press **Amp Cpl** to turn amplitude coupling "On" or "Off". When amplitude coupling is turned on, use the numeric keyboard or the direction keys and knob to input the desired amplitude deviation. Here, it is set to "1Vpp".

When the coupling base is set to "CH2", the frequency, phase and amplitude relations of CH1 and CH2 are as follows.

$$F_{CH1} = F_{CH2} + 100\text{HZ} \quad P_{CH1} = P_{CH2} + 10^\circ \quad A_{CH1} = A_{CH2} + 1\text{Vpp}$$

A green "*" mark is displayed on the left of the frequency, phase and amplitude of

the coupling base respectively as shown in the figure below, indicating that the generator is in frequency, phase and amplitude couplings. Change the frequency, phase and amplitude of CH2 to 100Hz, 0° and 1Vpp respectively and the parameters of CH1 will change to 200Hz, 10° and 2Vpp automatically.

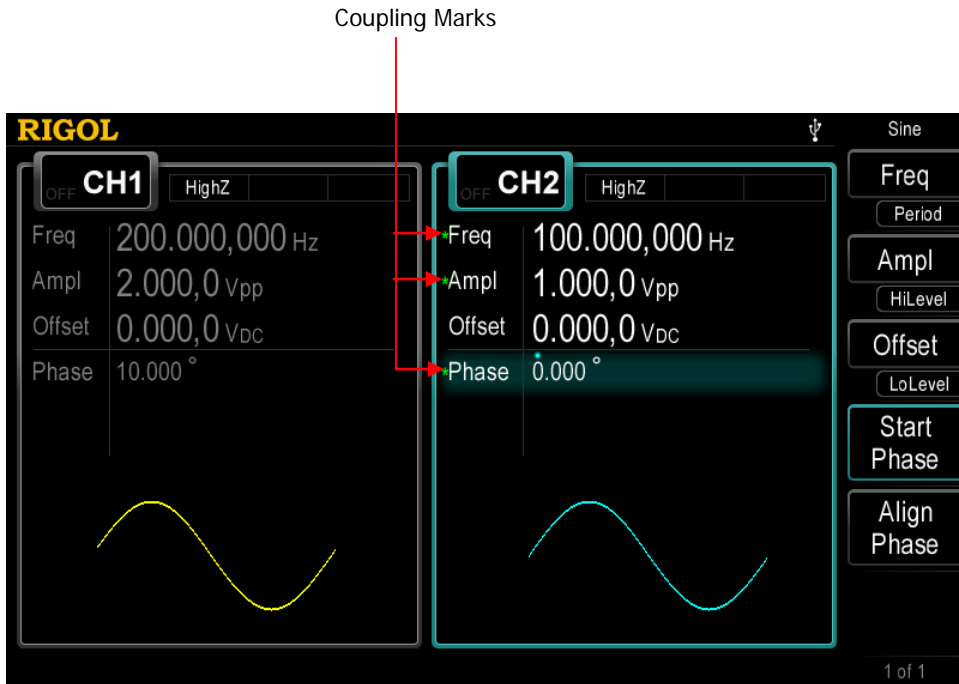

Figure 10-4 Channel Coupling

Key Points:

- Channel coupling is only available when the waveforms of the two channels are basic waveforms, including Sine, Square, Ramp and Arbitrary waveform (except DC).
- If the sum of the frequency, phase or amplitude of the base channel and the corresponding deviation set exceeds the upper limit of frequency, phase or amplitude of the non-base channel, the generator will adjust the frequency, phase or amplitude of the non-base channel to avoid parameter overrange.
- The frequency, phase and amplitude of the non-base channel cannot be modified directly.
- When the phase of the base channel is changed, the phase (phase displayed on the interface) of the non-base channel will change accordingly. At this point, align phase between the two channels can be realized without executing the **Align Phase** operation.

- Channel coupling and channel copy are mutually exclusive. The prompt message "Channel copy not allowed in Coupling mode." would be displayed if users execute channel copy operation (press **CH1=CH2** at the front panel) when channel coupling is enabled.

Channel Copy

DG4000 supports state copy or waveform copy function between its two channels, namely copy the state (parameters and output configuration) or arbitrary waveform parameters of one channel to the other or swap the states of the two channels.

Press **Utility** → **Channel Copy** to set the parameters of channel copy. This setting will not be affected by the preset operation.

1. Copy Type

Press **Type** at the front panel to set the content of channel copy to "State" or "Wform".

- State: include waveform (except volatile waveform) and waveform parameters (such as frequency and amplitude), functions (such as modulation, sweep and burst) as well as output configurations (such as sync, resistance and polarity) of the channel.
- Wform: arbitrary waveform data (except waveform parameters). Available only when both of the two channels select arbitrary waveforms.

2. Copy Direction

Press **Direction** to set the direction of channel copy as "CH1->CH2", "CH2->CH1" or "Swap" ("Swap" is only available when the copy type is set to "State").

Then, pressing **CH1=CH2** at the front panel under any interface can execute the channel copy operation.

Note: Channel coupling and channel copy are mutually exclusive. Channel copy is forbidden when channel coupling is enabled.

User-defined Waveform Key

User at the front panel of DG4000 provides a shortcut for users. You can define this shortcut key as the desired built-in waveform or arbitrary waveform stored in the internal memory of the instrument. You can recall the desired waveform under any operation interface once you press this shortcut key.

To modify the waveform recalled by this shortcut key, press **Utility** → **UserKey** to open the shortcut waveform defining interface. Select a type by pressing the menu softkey at the right side of the screen; use the knob to select the desired waveform (such as: AbsSine), use  to open the 2/2 menu page and then press **Select** to select the specified waveform.

Note: For arbitrary waveforms, you can only press **User** to recall the arbitrary waveform selected after you specify the waveform only when arbitrary waveforms are stored in the specified storage location of the internal memory of the instrument.



Figure 10-5 Waveform Defining Interface

After that, pressing **User** under any interface would output the waveform selected from the corresponding channel (if it is currently turned on) and you can also

modify the waveform parameters.

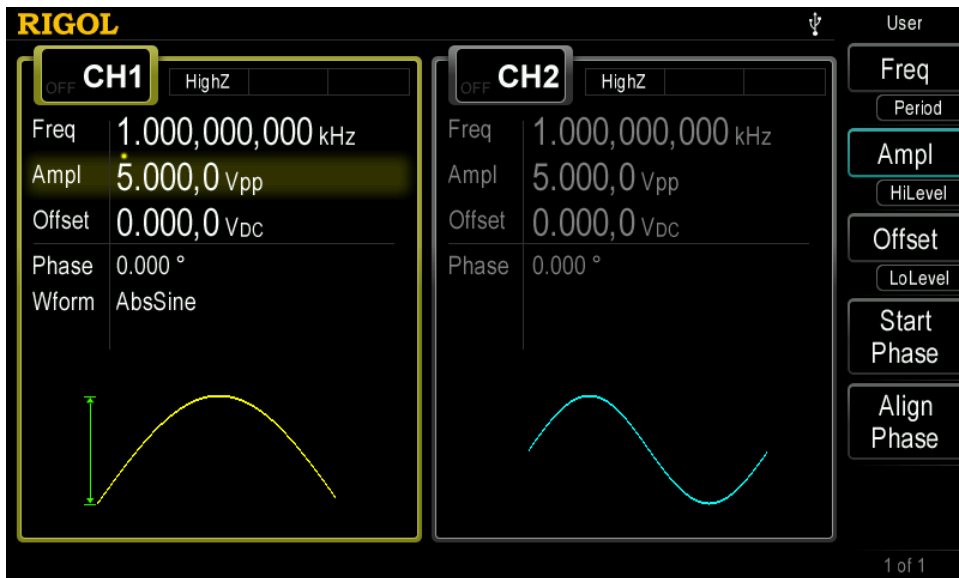

Figure 10-6 Press **User** to Quickly Recall the Waveform

To Restore the Preset Configuration

Restore the generator to its factory default state or states stored.

- Factory Default State: the parameter values are as shown in the table below. Note that items marked with "*" will not be affected by the preset operation.
- States Stored: correspond to the 10 state files stored in the internal memory.

Press **Utility** → **Preset** to select "Default" or one of "User1" to "User10". After that, pressing **Preset** at the front panel under any state will switch the instrument to the specified state. Note that before selecting any of "User1" to "User10", make sure that valid state file is stored in the corresponding storage location.

Table 10-1 Factory Default Values

Parameters	Defaults
Channel Parameters	
Current Carrier	Sine
Output Resistance	HighZ
Sync Output	On
Sync Polarity	Pos
Output Polarity	Normal
Noise Superimposition	Off
Noise Scale	10%
Coupling	Off
Coupling Base	CH1
Phase Deviation	0°
Frequency Deviation	0μHz
Amplitude Deviation	0Vpp
Basic Waveform	
Frequency	1kHz
Amplitude	5Vpp
Amplitude Unit	Vpp
Offset	0Vdc
Start Phase	0°
Square Duty Cycle	50%

Ramp Waveform Symmetry	50%
Pulse Duty Cycle	50%
Pulse Width	500 μ s
Pulse Leading Edge	1.9531 μ s
Pulse Trailing Edge	1.9531 μ s
Arb Waveform	
Built-in Arbitrary Waveform	Sinc
Point By Point Output	Off
Harmonic	
Order	2
Type	Even
Amplitude	1.264,7Vpp
Phase	0°
AM Modulation	
Modulation Source	Int
Modulating Waveform	Sine
AM Frequency	100Hz
Modulation Depth	100%
FM Modulation	
Modulation Source	Int
Modulating Waveform	Sine
FM Frequency	100Hz
Frequency Deviation	1kHz
PM Modulation	
Modulation Source	Int
Modulating Waveform	Sine
PM Frequency	100Hz
Phase Deviation	90°
PWM Modulation	
Modulation Source	Int

Modulating Waveform	Sine
Modulating Frequency	100Hz
Width Deviation	200 μ s
Duty Cycle Deviation	20%
ASK Modulation	
Modulation Source	Int
ASK Rate	100Hz
Modulating Amplitude	2Vpp
ASK Polarity	Pos
FSK Modulation	
Modulation Source	Int
FSK Rate	100Hz
Hop Frequency	10kHz
FSK Polarity	Pos
PSK Modulation	
Modulation Source	Int
PSK Rate	100Hz
PSK Phase	180°
PSK Polarity	Pos
BPSK Modulation	
Rate	100Hz
Phase	180°
Data Source	PN15
QPSK Modulation	
Rate	100Hz
Phase 1	45°
Phase 2	135°
Phase 3	225°
Data Source	PN15
3FSK Modulation	

Key Frequency	100Hz
Hop Frequency 1	100Hz
Hop Frequency 2	100Hz
4FSK Modulation	
Key Frequency	100Hz
Hop Frequency 1	100Hz
Hop Frequency 2	100Hz
Hop Frequency 3	100Hz
OSK Modulation	
Modulation Source	Int
Rate	1kHz
Oscillate Time	100 μ s
Sweep	
Sweep Type	Linear
Step	2
Sweep Time	1s
Start Hold	0s
End Hold	0s
Return Time	0s
Start Frequency	100Hz
End Frequency	1kHz
Center Frequency	550Hz
Frequency Span	900Hz
Mark Frequency	Off
Trigger Source	Int
Trigger Output	Off
Slope Input	Leading
Burst	
Burst Mode	N Cycle
Cycle Number	1
Start Phase	0°
Delay	0s

Gated Polarity	Pos
Trigger Source	Int
Trigger Output	Off
Trigger Input	Leading
Trigger Period	10ms
System Parameter	
DHCP	On
Auto IP	On
Manual IP	Off
Beeper	On
Power On Setting	Default
Screen Saver	On
Clock Source	Internal
Decimal Point	Dot
Thousand Separator	Comma
Brightness*	Factory Delivery Setting
Language*	Factory Delivery Setting
Print Destination	USB Storage Device
Picture Format	Bmp
Counter	
Sensitivity	50%
Trigger Level	0V
Input Resistance	HighZ
Coupling	AC
Attenuation	×1
HF Reject	OFF
Gate Time	1ms
Measurement Item	Frequency
Statistic Function	OFF
Display Format	Digital

To Use the External Power Amplifier (Option)

You can connect an external power amplifier to DG4000 and set the power amplifier parameters to amplify the signal before output. To use the external power amplifier, install the PA1011 option.

PA1011 is an optional accessory for **RIGOL** DG series function/arbitrary waveform generator. PA1011 provides 1MHz maximum full power bandwidth and greater than 80V/ μ s output slew rate. It can be used with any of the DG series products to quickly build a test platform or be used with other signal generators as an independent power amplifier.

Main features of PA1011:

- Flexible and easy communication with **RIGOL** DG series signal generator or PC via the USB interface.
- Users can set the gain (X1 or X10), polarity (normal or invert), output offset and output switch of the amplifier via **RIGOL** DG series signal generator or PC software.
- Provide up to 50k Ω input impedance.
- An integrated output protection circuit (output overcurrent protection and internal temperature abnormality protection) ensures the stable, reliable and safe operation of the instrument.
- Small in size, portable and easy to use.

Front Panel:

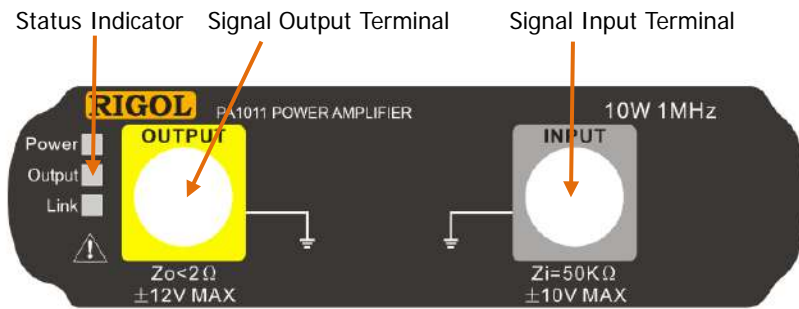

Status Indicators

- Power: illuminated in red indicating that the power is successfully connected.
- Output: illuminated in green indicating that the output is turned on.
- Link: illuminated in yellow indicating that the USB connection is successful.



CAUTION

The input impedance of the instrument (Z_i) is $50k\Omega$. The range of the input voltage is from $-10V$ to $+10V$ when the voltage gain is X1 and from $-1.25V$ to $+1.25V$ when the voltage gain is X10. When the input exceeds these ranges, the instrument might be damaged or danger might occur.



CAUTION

The output impedance of the instrument (Z_o) is lower than 2Ω . The range of the output voltage is from $-12V$ to $+12V$. The actual output voltage can reach $\pm 12.5V$, but the total harmonic distortion of the waveform will increase.

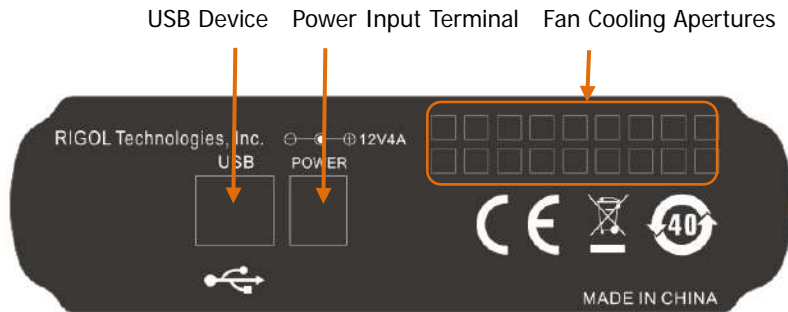
Rear Panel:**CAUTION**

Do not use other type of adapter to provide power for PA1011; otherwise, the instrument performance might be affected or the instrument might be permanently damaged.

**CAUTION**

Make sure that the vents at the side and the fan cooling apertures at the rear panel of PA1011 are not blocked during operation to avoid affecting the normal operation of the instrument.

PA1011 Accessories:

Name	Qty.	Explanation
Power Cord	1	Connect the AC power to the power adapter.
Power Adapter	1	Output 12V, 4A signal.
USB Cable	1	Connect PA1011 and DG4000.
BNC Cable	1	Connect PA1011 and DG4000.
CD	1	Provide the PC software installation program of PA1011.

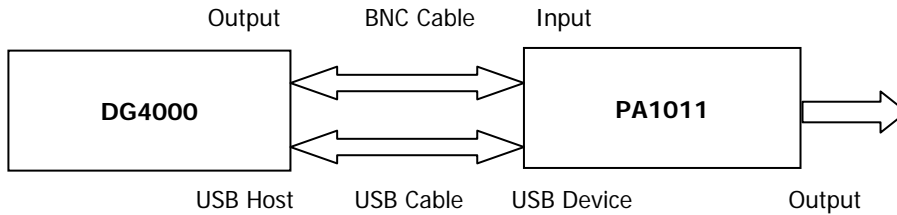
Connect DG4000 and PA1011:

After DG4000 and PA1011 are successfully connected as shown in the figure above, press **Utility** → **PA Set** to open the parameter setting interface of the power amplifier.

1. Switch

Press this key to turn "On" or "Off" the external power amplifier. When it is turned on, PA amplifies the input signal (namely the output signal of the signal generator) and then output it. When it is turned off, there is no output from PA.

2. Gain

Press this key to set the amplification gain of the signal at the output terminal of the power amplifier to "X1" or "X10". Wherein, "X1" indicates output without gain and "X10" indicates amplifying the signal for 10 times and then output it.

3. Output

Press this key to set the signal at the output terminal of the power amplifier to "Normal" or "Invert". Pay attention to distinguish it from the "**Output Polarity**" of DG4000.

4. Offset

Press this key to turn "On" or "Off" the output offset at the output terminal of the power amplifier. When it is turned "On", use the numeric keyboard or the direction keys and knob to set the offset and the range is from -12V to +12V (the default is 0V).

5. Store

Press this key to store the current working state of the power amplifier to its

internal memory. When the power amplifier is turned "On" the next time, it will automatically recall the last working state stored.

Tip

For the technical specifications of PA1011, refer to "**Appendix B: Power Amplifier Specifications**".

To Lock the Keys

You can lock any of the keys or all of the keys (except the power key) at the front panel using the key locking command.

1. Key locking command introduction

:SYSTem:KLOCK <key>,{ON|OFF|0|1} /*Lock or unlock the specified key*/

:SYSTem:KLOCK? <key> /*Query whether the specified key is locked*/

Wherein, <key> is used to specify the key and the ranges are as follows.

SINE|SQUARE|RAMP|PULSE|NOISE|
ARB|HARMONIC|USER /*Waveform selecting keys*/

MOD|SWEEP|BURST /*Mode selecting keys*/

UTILITY|STORE|HELP|PRINT|EDIT|PRESET /*Shortcut keys/Utility function keys*/

M1|M2|M3|M4|M5|M6 /*Menu softkeys*/

RETURN /*Return to the previous menu key */

PAGE /*Menu page up/down key*/

OUTPUT1|OUTPUT2|CH1|CH2|TRIGGER1|
TRIGGER2|CHCOPY /*Channel control keys*/

LEFT RIGHT KNOB	/*Direction keys and knob*/
NUM0 NUM1 NUM2 NUM3 NUM4 NUM5 NUM6 NUM7 NUM8 NUM9 DOT SIGN ENTER CANCEL DELETE	/*Numeric keyboard*/
COUNTER	/*Frequency counter*/
ALL	/*All the keys (except the power key) and knob at the front panel*/

{ON|OFF|0|1} is used to lock or unlock the keys and can be ON|1 (locking the specified key) or OFF|0 (unlocking the specified key).

2. Using the following 3 modes to lock or unlock the keys

(1) Send command via Ultra Sigma to lock or unlock the specified key

- Build the communication between the signal generator and PC.
- Run Ultra Sigma and search for instrument resource.
- Open the remote command control panel and send the command.

(2) Program and send command to lock or unlock the specified key

- Build the communication between the signal generator and PC.
- Use a programming language (such as LabVIEW and C#) to program and send command.

(3) Read the command file in the USB storage device to lock or unlock the specified key

The content and format requirements of the command file are as follows.

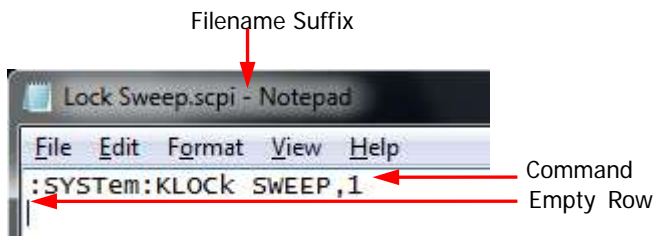

- The filename suffix must be ".scpi".
- The file content requirements:
 - The first row: the command used to lock or unlock the specified key.
 - The second row: empty row (cannot be omitted).

Note: The command file can contain multiple rows (for example, N rows). The first N - 1 rows are the commands used to lock or unlock the specified keys and the Nth row is empty. At this point, you can execute N - 1 locking or unlocking operations by reading the file via the instrument.

Steps:

- Edit the command file that meets the above requirements and store it to a USB storage device.
- Start the instrument and insert the USB storage device into it; press **Store** to enter the store and recall interface.
- In the store and recall interface, read the command file by following the steps below (refer to "**Store and Recall**").

Select D disk → press **File Type** to select "All File" → select the file mentioned above → press **Read**.

Chapter 11 Remote Control

DG4000 can be controlled remotely through the following two methods.

User-defined programming

Users can program and control DG4000 by using the SCPI (Standard Commands for Programmable Instruments) commands. For more information about the commands and programming, refer to the *DG4000 Programming Guide*.

Use PC software

Users can use the PC software to send commands to remotely control DG4000. Ultra Sigma of **RIGOL** is recommended. You can download the latest version of Ultra Sigma from **RIGOL** official website (www.rigol.com).

DG4000 can communicate with PC through USB and LAN instrument buses. This chapter will give a detailed introduction of how to use Ultra Sigma to control DG4000 remotely through various interfaces.

Subjects in this chapter:

- Remote Control via USB
- Remote Control via LAN

Remote Control via USB

1. Connect the device

Connect the signal generator (USB Device interface) with your PC using a USB cable.

2. Install the USB driver

This signal generator is a USBTMC device. After you connect the signal generator to the PC and turn on the signal generator for the first time (the signal generator is automatically configured to USB interface; at the same time, make sure that **Utility** → **I/O Config** → **USB Dev** is set to "PC"), the **Found New Hardware Wizard** dialog box as shown in the figure below is displayed on the PC. Please install the "USB Test and Measurement Device (IVI)" driver following the directions in the wizard. The steps are as follows.

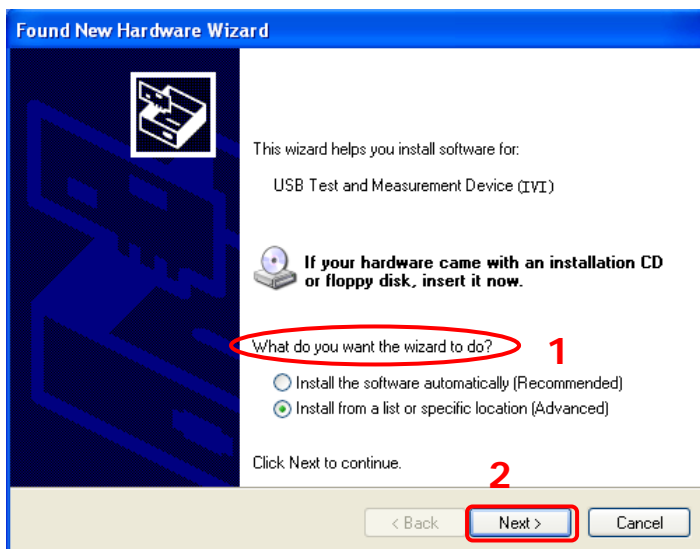

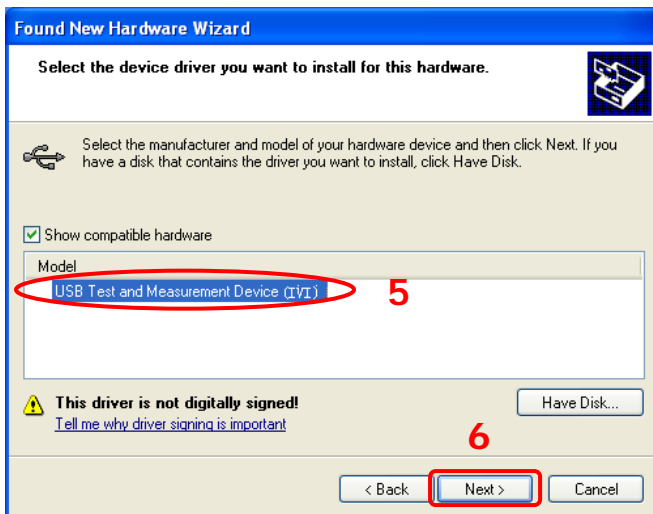
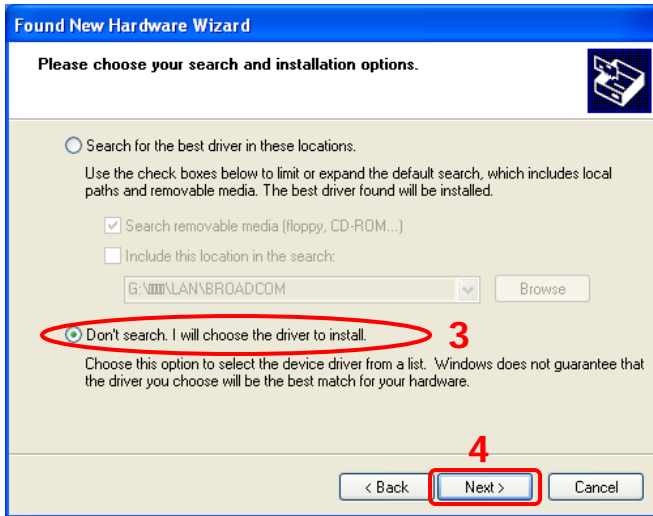

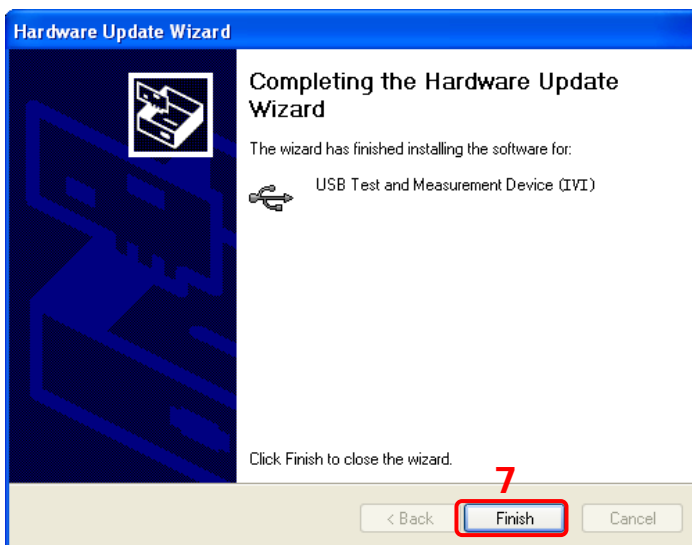
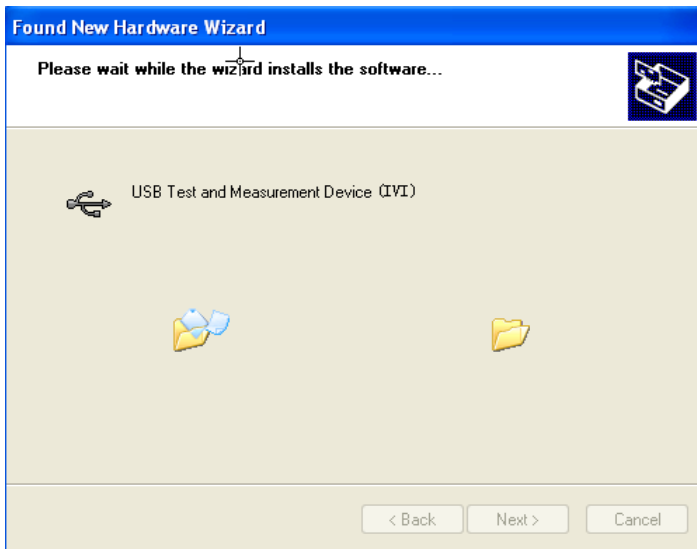

3. Search for device resource

Start up Ultra Sigma and the software will automatically search for the instrument resource currently connected to the PC via the USB interface. You can also click **USB-TMC** to search for the resources.

4. View the device resource

The resource found will appear under the "RIGOL Online Resource" directory and the model number and USB interface information of the instrument will

also be displayed.

For example, DG4162 (USB0::0x1AB1::0x0641::DG410520023::INSTR).

5. Control the instrument remotely

Right click the resource name

"DG4162 (USB0::0x1AB1::0x0641::DG410520023::INSTR)" to select "SCPI Panel Control" to open the remote command control panel through which you can send commands and read data.

Remote Control via LAN

1. Connect the device

Connect the signal generator to your LAN using a network cable.

2. Configure the network parameters

Configure the network parameters of the signal generator according to "LAN Setting".

3. Search for device resource

Start up Ultra Sigma and click **LAN** to open the panel as shown in figure below. Click **Search** and the software will search for the instrument resource currently connected to the LAN; the resource found is displayed at the right of the panel. Click **OK** to add the resource. Note: If you want to remove the unwanted resource, click the corresponding resource name and click **Remove**.



4. View the device resource

The resource found will appear under the "RIGOL Online Resource" directory. For example, DG4162 (TCPIP::172.16.3.190::INSTR).

5. Control the instrument remotely

Right click the resource name "DG4162 (TCPIP::172.16.3.190::INSTR)" to select "SCPI Panel Control" to open the remote command control panel through which you can send commands and read data.

6. Load LXI webpage

As this signal generator conforms to LXI Core 2011 Device instrument standard, you can load the LXI webpage through Ultra Sigma (right-click the instrument resource name and select "LXI-Web"). Various important information about the signal generator (include the model number, manufacturer, serial number, description, MAC address and IP address) will be displayed on the webpage.

In the LXI webpage, click "Network Settings" at the left side; then, input the initial password "123456" (not include the double quotation marks) in the pop-up window (by default, the user name is empty) and click "OK" to view or modify the current network settings of the instrument. Besides, you can click "Security" to reset the password.

Tip

You can also load the LXI webpage by entering the IP address of the instrument in the address bar of the PC browser.

Chapter 12 Troubleshooting

This chapter lists the commonly encountered failures of DG4000 and their solutions. When you encounter those problems, please solve them following the corresponding steps. If the problem persists, please contact **RIGOL** and provide your device information (**Utility** → **System** → **System Info**).

1. The screen is still dark (no display) after on the power switch is pressed:

- (1) Check whether the power is correctly connected.
- (2) Check whether the power switch is really on.
- (3) Restart the instrument after finishing the above inspections.
- (4) If it still does not work correctly, please contact **RIGOL**.

2. The screen is too dark to see the contents on the screen clearly:

- (1) Check whether the brightness setting value of the screen is too small.
- (2) Press **Utility** → **System** → **Bright** and use the numeric keyboard or knob to adjust the brightness of the signal generator screen to a proper value.

3. The generator is locked:

- (1) Check whether the generator is working in remote mode ( is displayed in the status bar of the user interface). Press **Burst** to exit the remote control mode and unlock the front panel.
- (2) Restarting the generator can also unlock the generator.
- (3) Check whether the keys at the front panel of the signal generator are locked. If yes, unlock the keys at the front panel by referring to "**To Lock the Keys**".

4. The settings are correct but no waveform is generated:

- (1) Check whether the BNC cable is tightly connected to the corresponding channel output terminal (**[Output]**).
- (2) Check whether the BNC cable has internal damage.
- (3) Check whether the BNC cable is connected to the test instrument tightly.
- (4) Check whether the backlight of **Output1** or **Output2** is turned on. If not, press the corresponding key to turn the backlight on.

- (5) After finishing the above inspections, press **Utility** → **System** → **PowerOn** to select "Last" and then restart the instrument.
- (6) If it still does not work correctly, please contact **RIGOL**.

5. The USB storage device cannot be recognized:

- (1) Check whether the USB storage device can work normally when connected to other instruments or PC.
- (2) Make sure to use FAT32 formatted USB storage device which is flash type. The generator doesn't support hard drive-based USB storage device.
- (3) Restarting the instrument and insert the USB storage device again to check whether it can work normally.
- (4) If the USB storage device still cannot be used normally, please contact **RIGOL**.

6. How to set the amplitude of the waveform in dBm?

- 1) Press **CH1** or **CH2** to select the desired channel.
- 2) Press **Utility** → **CH1Set** (or **CH2Set**) → **Imped** to check whether the setting is "HighZ". If yes, you cannot set the amplitude of the waveform in dBm at this time. Press **Imped** to select "Load" and use the numeric keyboard or the direction keys and knob to set the impedance to a proper value.
- 3) Select the desired waveform and press **Ampl/HiLevel** to highlight "Ampl". Input the desired value using the numeric keyboard and select the unit "dBm" from the pop-up menu.

7. The instrument does not pass the performance verification test:

- 1) Check whether the generator is within the calibration period (1 year).
- 2) Check whether the generator is warmed up for at least 30 minutes before the test.
- 3) Check whether the generator is under the specified environment temperature.
- 4) Check whether the test is under strong-magnetic environment.
- 5) Check whether the power supplies of the generator and test system have strong interference.
- 6) Check whether the performance of the test device used meets the requirement.
- 7) Make sure that the test device used is within the calibration period.

- 8) Check whether the test devices used are under the working conditions specified in the corresponding manual.
- 9) Check whether all the connections are tight.
- 10) Check whether any cable has internal damage.
- 11) Make sure that the operations conform to the settings and processes specified by the performance verification guide.
- 12) Check whether the error calculation is correct.
- 13) Get a correct understanding of the definition of "typical value" for this product: the performance specifications of this product under the specified conditions.

Chapter 13 Specifications

All the specifications can be guaranteed if the following two conditions are met unless where noted.

- The generator is within the calibration period and has performed self-calibration.
- The generator has been working continuously for at least 30 minutes under the specified temperature (18°C to 28°C).

All the specifications are guaranteed unless those marked with "typical".

Model	DG4202	DG4162	DG4102	DG4062
Channel	2	2	2	2
Maximum Frequency	200MHz	160MHz	100MHz	60 MHz
Sample Rate	500MSa/s			
Waveforms				
Standard waveforms	Sine, Square, Ramp, Pulse, Noise, Harmonics			
Arbitrary Waveforms	150 kinds, including Sinc, Exponential Rise, Exponential Fall, ECG, Gauss, HaverSine, Lorentz, Dual-Tone, DC, etc.			
Frequency Characteristics				
Sine	1μHz to 200MHz	1μHz to 160MHz	1μHz to 100MHz	1μHz to 60MHz
Square	1μHz to 60MHz	1μHz to 50MHz	1μHz to 40MHz	1μHz to 25MHz
Ramp	1μHz to 5MHz	1μHz to 4MHz	1μHz to 3MHz	1μHz to 1MHz
Pulse	1μHz to 50MHz	1μHz to 40MHz	1μHz to 25MHz	1μHz to 15MHz
Harmonic	1μHz to 100MHz	1μHz to 80MHz	1μHz to 50MHz	1μHz to 30MHz
Noise (-3dB)	120MHz bandwidth	120MHz bandwidth	80MHz bandwidth	60MHz bandwidth
Arbitrary Waveform	1μHz to 50MHz	1μHz to 40MHz	1μHz to 25MHz	1μHz to 15MHz
Resolution	1μHz			
Accuracy	±2ppm, 18°C to 28°C			

Sine Wave Spectrum Purity			
Harmonic Distortion	Typical (0dBm) DC-1MHz: <-60dBc 1MHz-10MHz: <-55dBc 10MHz-100MHz: <-50dBc 100MHz-160MHz: <-40dBc		
Total Harmonic Distortion	<0.1% (10Hz-20kHz,0dBm)		
Spurious (non-harmonic)	Typical (0dBm) ≤10MHz <-65dBc >10MHz <-65dBc+6dB/octave		
Phase Noise	Typical (0dBm, 10kHz deviation) 10MHz: ≤-115dBc/Hz		
Signal Characteristics			
Square			
Rise/Fall Time	Typical (1Vpp) <8ns	Typical (1Vpp) <10ns	Typical (1Vpp) <12ns
Overshoot	Typical (100kHz, 1Vpp) <3%		
Duty Cycle	≤10MHz: 20.0% to 80.0% 10MHz-40MHz: 40.0% to 60.0% >40MHz: 50.0% (fixed)		
Non-symmetry	1% of period +5ns		
Jitter (rms)	Typical (1MHz, 1Vpp, 50Ω) ≤5MHz 2ppm+500ps >5MHz 500ps		
Ramp			
Linearity	≤1% of peak output (Typical, 1kHz, 1VPP, 100% Symmetry)		
Symmetry	0% to 100%		
Pulse			
Period	25ns to 1000000s	40ns to 1000000s	66.7ns to 1000000s
Pulse Width	≥10ns	≥12ns	≥18ns
Leading/ Trailing Edge Time	≥5ns	≥7ns	≥11ns

Overshoot	Typical (1Vpp) <3%			
Jitter (rms)	Typical (1Vpp) ≤5MHz 2ppm+500ps >5MHz 500ps			
Arb				
Waveform Length	16k points			
Vertical Resolution	14bits			
Sample Rate	500MSa/s			
Minimum Rise/Fall Time	Typical (1Vpp) <5ns			
Jitter (rms)	Typical (1Vpp) ≤5MHz 2ppm+500ps >5MHz 500ps			
Interpolation Method	Off, Linear			
Edit Method	Edit Points, Edit Block			
Harmonic				
Harmonic Order	≤16			
Harmonic Type	Even, Odd, All, User			
Harmonic Amplitude	can be set for all harmonics			
Harmonic Phase	can be set for all harmonics			
Output Characteristics				
Amplitude (into 50 Ω)				
Range	≤20MHz: 1mVpp to 10Vpp ≤70MHz: 1mVpp to 5Vpp ≤120MHz: 1mVpp to 2.5Vpp ≤160MHz: 1mVpp to 1Vpp	≤20MHz: 1mVpp to 10Vpp ≤70MHz: 1mVpp to 5Vpp ≤100MHz: 1mVpp to 2.5Vpp	≤20MHz: 1mVpp to 10Vpp ≤60MHz: 1mVpp to 5Vpp	
Accuracy	Typical (1kHz Sine, 0V Offset, >10mVpp, Auto) ± 1% of setting ± 2mVpp			
Flatness (relative to 1kHz)	Typical ≤10MHz:	Typical ≤10MHz:	Typical ≤10MHz:	Typical ≤10MHz:

Sine wave, 500mVpp, 50Ω)	±0.1dB ≤60MHz: ±0.2dB ≤100MHz: ±0.4dB ≤160MHz: ±0.8dB ≤200MHz: ±1dB	±0.1dB ≤60MHz: ±0.2dB ≤100MHz: ±0.4dB ≤160MHz: ±0.8dB	±0.1dB ≤60MHz: ±0.2dB ≤100MHz: ±0.4dB	±0.1dB ≤60MHz: ±0.2dB
Units	Vpp, Vrms, dBm			
Resolution	1mV or 3bits			
Offset (into 50 Ω)				
Range	±5Vpk ac + dc			
Accuracy	±(1% of setting + 5mV + 0.5% of amplitude)			
Waveform Output				
Impedance	50Ω (Typical)			
Protection	Short-circuit protection, automatically disable waveform output when overload occurs			
Modulation Characteristics				
Modulation Type	AM, FM, PM, ASK, FSK, PSK, BPSK, QPSK, 3FSK, 4FSK, OSK, PWM			
AM				
Carrier Waveform	Sine, Square, Ramp, Arb (except DC)			
Source	Internal/External			
Modulating Waveform	Sine, Square, Ramp, Noise, Arb			
Depth	0% to 120%			
Modulating Frequency	2mHz to 50KHz			
FM				
Carrier Waveform	Sine, Square, Ramp, Arb (except DC)			
Source	Internal/External			
Modulating Waveform	Sine, Square, Ramp, Noise, Arb			
Modulating Frequency	2mHz to 50KHz			

PM	
Carrier Waveform	Sine, Square, Ramp, Arb (except DC)
Source	Internal/External
Modulating Waveform	Sine, Square, Ramp, Noise, Arb
Phase Deviation	0° to 360°
Modulating Frequency	2mHz to 50KHz
ASK	
Carrier Waveform	Sine, Square, Ramp, Arb (except DC)
Source	Internal/External
Modulating Waveform	Square with 50% duty cycle
Key Frequency	2mHz to 1MHz
FSK	
Carrier Waveform	Sine, Square, Ramp, Arb (except DC)
Source	Internal/External
Modulating Waveform	Square with 50% duty cycle
Key Frequency	2mHz to 1MHz
3FSK	
Carrier Waveform	Sine, Square, Ramp, Arb (except DC)
Source	Internal
Modulating Waveform	Square with 50% duty cycle
Key Frequency	2mHz to 1MHz
4FSK	
Carrier Waveform	Sine, Square, Ramp, Arb (except DC)
Source	Internal
Modulating Waveform	Square with 50% duty cycle
Key Frequency	2mHz to 1MHz
PSK	
Carrier Waveform	Sine, Square, Ramp, Arb (except DC)
Source	Internal/External
Modulating	Square with 50% duty cycle

Waveform			
Key Frequency	2mHz to 1MHz		
BPSK			
Carrier Waveform	Sine, Square, Ramp, Arb (except DC)		
Source	Internal		
Modulating Waveform	Sine, Square, Ramp, Noise, Arb		
Key Frequency	2mHz to 1MHz		
QPSK			
Carrier Waveform	Sine, Square, Ramp, Arb (except DC)		
Source	Internal		
Modulating Waveform	Sine, Square, Ramp, Noise, Arb		
Key Frequency	2mHz to 1MHz		
OSK			
Carrier Waveform	Sine		
Source	Internal/External		
Oscillation Time	8ns to 499.75µs		
Key Frequency	2mHz to 1MHz		
PWM			
Carrier Waveform	Pulse		
Source	Internal/External		
Modulating Waveforms	Sine, Square, Ramp, Noise, Arb		
Width Deviation	0% to 100% of Pulse Width		
Modulating Frequency	2mHz to 50KHz		
[Mod/FSK/Trig] Input			
Maximum Input Range	75mVRMS to ±2.5Vac+dc		
Input Bandwidth	5MHz		
Input Impedance	1kΩ		
Burst Characteristics			
Carrier Waveform	Sine, Square, Ramp, Pulse, Noise, Arb (except DC)		
Carrier Frequency	2mHz to 100MHz	2mHz to 100MHz	2mHz to

			60MHz
Burst Count	1 to 1 000 000 or Infinite		
Start/Stop Phase	0° to 360°		
Internal Period	2μs to 500s		
Gated Source	External Trigger		
Trigger Source	Internal, External or Manual		
Trigger Delay	0ns to 85s		
Sweep Characteristics			
Carrier Waveform	Sine, Square, Ramp, Arb (except DC)		
Type	Linear, Log or Step		
Direction	Up or Down		
Start/Stop Frequency	1μHz to 160MHz	1μHz to 100MHz	1μHz to 60MHz
Sweep Time	1ms to 300s		
Hold/Return Time	0ms to 300s		
Trigger Source	Internal, External or Manual		
Mark	Falling edge of Sync signal (programmable)		
Counter Specifications			
Function	Frequency, Period, Positive/Negative Pulse Width, Duty Cycle		
Frequency Resolution	7 digits/second (Gate Time = 1s)		
Frequency Range	1μHz to 200MHz		
Period Measurement	Measurement Range		5ns to 16 days
Voltage Range and Sensitivity (Not modulation signal)			
DC Coupling	DC Offset Range	±1.5V _{DC}	Input Attenuation: "closed"
	1μHz to 100MHz	50mVRMS to ±2.5Vac+dc	
	100MHz to 200MHz	100mVRMS to ±2.5Vac+dc	
AC Coupling	1μHz to 100MHz	50mVRMS to ±2.5Vpp	
	100MHz to 200MHz	100mVRMS to ±2.5Vpp	

Pulse Width and Duty Cycle Measurement			
Frequency/Amplitude Range	1μHz to 25MHz	50mVRMS to ±2.5Vac+dc	DC Coupling Input Attenuation: "closed"
Pulse Width	Minimum	≥20ns	
	Resolution	2ns	
Duty Cycle	Range (Display)	0% to 100%	
Input Characteristics			
Input Range	Breakdown Voltage	±7Vac+dc (Attenuation: closed)	Impedance=1 MΩ
		±70Vac+dc (Attenuation: open)	
		5Vrms	Impedance=50Ω
Input Adjustment	Attenuation	Open: "×10"; Closed: "×1"	
	Impedance	50Ω	1MΩ
	Coupling	AC	DC
	HF Reject	ON: input bandwidth=250kHz; OFF: input bandwidth=225MHz	
Input Trigger	Trigger Level Range	-2.5V to +2.5V	
	Trigger Sensitivity Range	0% (140mV hysteresis voltage) to 100% (2mV hysteresis voltage)	
Gate Time	GateTime1	1ms	
	GateTime2	10ms	
	GateTime3	100ms	
	GateTime4	1s	
	GateTime5	10s	
	GateTime6	>10s	
Trigger Characteristics			
Trigger Input			
Level	TTL-compatible		

Slope	Rising or falling (selectable)	
Pulse Width	>50ns	
Latency	Sweep: <100ns (typical) Burst: <300ns (typical)	
Trigger Output		
Level	TTL-compatible	
Pulse Width	>60ns (typical)	
Maximum Rate	1MHz	
Clock Reference		
Phase Offset		
Range	0° to 360°	
Resolution	0.03°	
External Reference Input		
Lock Range	10MHz ± 50Hz	
Level	250mVpp to 5Vpp	
Lock Time	<2s	
Impedance (Typical)	1kΩ, AC coupling	
Internal Reference Output		
Frequency	10MHz ± 50Hz	
Level	3.3Vpp	
Impedance (Typical)	50Ω, AC coupling	
Sync Output		
Level	TTL-compatible	
Impedance	50 Ω, nominal value	
Programming Time (Typical)		
	USB 2.0	LAN
Function Variation	500ms	510ms
Frequency Variation	50ms	50ms
Amplitude Variation	300ms	310ms
Select User Arbitrary Waveform	500ms	510ms
General Specifications		

Power	
Power Voltage	100V to 240V (45Hz to 440Hz)
Power Consumption	Less than 50W
Fuse	250V, T2A
Display	
Type	7-inch TFT LCD
Resolution	800 Horizontal × RGB × 480 Vertical Resolution
Color	16M color
Environment	
Temperature Range	Operating: 10°C to 40°C Non-Operating: -20°C to 60°C
Cooling Method	Cooling by fans compulsively
Humidity Range	Less than 35°C: ≤90% Relative Humidity (RH) 35°C to 40°C: ≤60% Relative Humidity (RH)
Altitude	Operating: Less than 3000 meters Non-Operating: Less than 15000 meters
Mechanical	
Dimensions (W×H×D)	313 mm ×160.7 mm×116.7mm
Weight	without package: 3.2 kg with package: 4.5 kg
Interfaces	
USB Host, USB Device, LAN	
IP Protection	
IP2X	
Calibration Interval	
Recommend 1 year for standard interval	

Chapter 14 Appendix

Appendix A: Options and Accessories

	Description	Order Number
Model	DG4202 (200MHz, dual-channel)	DG4202
	DG4162 (160MHz, dual-channel)	DG4162
	DG4102 (100MHz, dual-channel)	DG4102
	DG4062 (60MHz, dual-channel)	DG4062
Standard Accessories	Power Cord	--
	USB Cable	CB-USBA-USBB-FF-150
	BNC Cable (1 meter)	CB-BNC-BNC-MM-100
	Quick Guide	--
	Warranty	--
Optional Accessories	40dB Attenuator	RA5040K
	Rack Mount Kit	RM-DG4000
	10W Power Amplifier Module	PA1011
	DG4 PC Software (Advanced Function Software)	Ultra Station-adv
	Soft Carrying Bag	BAG-G1

Note: All the options or accessories can be ordered from you local **RIGOL** office.

Appendix B: Power Amplifier Specifications

Unless otherwise noted, all the specifications can be guaranteed under the following two conditions.

- The instrument has been working continuously for at least 30 minutes under the specified operation temperature.
- All the specifications are guaranteed except those marked with "Typical".

Signal Input	
Input Impedance	50k Ω
Built-in Bias Voltage (output equivalent)	$\pm 12V$
External Input	$\pm 10V_{max}$ (gain: X1) $\pm 1.25V_{max}$ (gain: X10)
Power Amplifier Specifications	
Running Mode	Constant voltage
Gain	Switch between 10V/1V and 10V/10V (DC gain error <5%)
Polarity Switch	Normal/Invert
Effective Value of Sine Output Power (RL=7.5 Ω)	10W (Typical, Sine input, 100kHz, X10)
Output Voltage	12.5V _{peak} (Sine input, 100kHz)
Output Current	1.65A _{peak} (Sine input, 100kHz)
Output Impedance	<2 Ω
Full Power Bandwidth ^[1]	DC to 1MHz
Output Slew Rate ^[2]	$\geq 80V/\mu s$ (Typical)
Overshoot	<7%
Bias Voltage Specification	
Bias Voltage Gain Error	5% $\pm 100mV$
Others	
Power	DC 12V $\pm 5\%$, 4A _{peak}
Output Protection	Output overcurrent protection, internal temperature

	abnormity protection
Operating Temperature ^[3]	0°C to +35°C
Dimensions (W×H×D)	142.2mm×48.1mm×215.4mm
Net Weight	850g±20g

Note^[1]: Full power bandwidth refers to the maximum frequency when the power amplifier can generate the AC output with the maximum possible amplitude and without distortion.

$$\text{Full power bandwidth } FPB = \frac{SR}{2\pi V_{\max}}$$

SR: Slew Rate (output slew rate)

V_{max}: the maximum output amplitude without distortion of the power amplifier

Note^[2]: Definition of Output Slew Rate: input a large step-function signal into the power amplifier and the output slope of the signal would be saturated to a fixed constant at a certain position. This constant is called the Slew Rate of the power amplifier.

Note^[3]: The specifications above are obtained under 25 °C. The range of the environment temperature of PA1011 during operation is from 0 °C to +35 °C. You are recommended to reduce the output power and working power of PA1011 when the environment temperature exceeds 35 °C.

Appendix C: Warranty

RIGOL warrants that the product mainframe and product accessories will be free from defects in materials and workmanship within the warranty period.

If a product proves defective within the respective period, **RIGOL** guarantees free replacement or repair of any defective products within a reasonable period of time. To get repair service, please contact with your nearest **RIGOL** sales or service office.

There is no other warranty, expressed or implied, except such as is expressly set forth herein or other applicable warranty card. There is no implied warranty of merchantability or fitness for a particular purpose. Under no circumstances shall **RIGOL** be liable for any consequential, indirect, ensuing or special damages for any breach of warranty in any case.

Index

- 3FSK 5-26
- 4FSK 5-28
- AC Power Input 1-13
- AM 5-2
- amplitude 2-5
- amplitude coupling 10-22
- ASK 5-12
- AutoIP 10-11
- BPSK 5-21
- built-in waveform 3-5
- Burst 7-2
- Burst delay 7-7
- Burst period 7-6
- Burst phase 7-6
- Burst Polarity 7-6
- Center Frequency 6-3
- Channel Copy 10-25
- clock source 10-16
- counter 8-1
- coupling 10-22
- Coupling Base 10-22
- Create New Arbitrary Waveform . 3-11
- DC offset 2-8
- DDS Hold 10-7
- Default Gateway 10-12
- DHCP 10-11
- DNS 10-13
- Duty Cycle 2-12
- Duty cycle deviation 5-35
- Edit Block 3-12
- Edit Points 3-12
- end frequency 6-2
- End Hold 6-9
- External Power Amplifier 10-33
- FM 5-6
- Frequency 2-4
- frequency coupling 10-22
- Frequency deviation 5-8
- frequency span 6-3
- Frequency Sweep 6-2
- front panel 1-6
- FSK 5-15
- Gated Burst 7-4
- harmonic 4-1
- Harmonic Amplitude 4-4
- Harmonic Order 4-3
- harmonic type 4-3
- Infinite Burst 7-3
- Leading edge 2-15
- Linear Interpolation 3-12
- Linear Sweep 6-4
- Log Sweep 6-5
- MAC Address 10-10
- ManualIP 10-11
- Mark Frequency 6-8
- Modulating Polarity 5-14
- Modulation depth 5-4
- N Cycle 7-2
- Network Status 10-10
- Noise Setting 10-7
- noise superposition 10-7
- Oscillate period 5-32
- OSK 5-30
- Output Polarity 10-5
- phase coupling 10-22
- Phase deviation 5-11
- PictBridge 10-19
- PM 5-9

Point By Point Output	3-4	Symmetry	2-13
Power Key	1-6	Sync Mode	10-5
PSK	5-18	Sync Output	10-3
Pulse Width	2-14	Sync Polarity	10-4
PWM	5-33	Test/Cal	10-21
QPSK	5-24	To Edit Arbitrary Waveform	3-18
Range	10-7	To Recall File	9-8
rear panel	1-13	To Save File	9-6
Resistance setting	10-6	To Set Harmonic Phase	4-5
Return Time	6-8	Trailing edge	2-15
Start Frequency	6-2	USB Device	1-14
Start Hold	6-9	USB Host	1-6
start phase	2-9	user interface	1-18
Step Sweep	6-6	User-defined Waveform Key	10-26
Subnet Mask	10-12	VISA Descriptor	10-10
Supporting Legs	1-3	Volatile Waveform	3-10
Sweep Time	6-7	Width deviation	5-35
sweep trigger source	6-10		