

RIGOL

Programming Guide

DSG3000B Series RF Signal Generator

Aug. 2020
RIGOL TECHNOLOGIES CO., LTD.

Guaranty and Declaration

Copyright

© 2020 **RIGOL** TECHNOLOGIES CO., LTD. All Rights Reserved.

Trademark Information

RIGOL® is the trademark of **RIGOL** TECHNOLOGIES CO., LTD.

Publication Number

PGG03100-1110

Software Version

00.01.00

Software upgrade might change or add product features. Please acquire the latest version of the manual from **RIGOL** website or contact **RIGOL** to upgrade the software.

Notices

- **RIGOL** products are covered by P.R.C. and foreign patents, issued and pending.
- **RIGOL** reserves the right to modify or change parts of or all the specifications and pricing policies at the company's sole decision.
- Information in this publication replaces all previously released materials.
- Information in this publication is subject to change without notice.
- **RIGOL** shall not be liable for either incidental or consequential losses in connection with the furnishing, use, or performance of this manual, as well as any information contained.
- Any part of this document is forbidden to be copied, photocopied, or rearranged without prior written approval of **RIGOL**.

Product Certification

RIGOL guarantees that this product conforms to the national and industrial standards in China as well as the ISO9001:2015 standard and the ISO14001:2015 standard. Other international standard conformance certifications are in progress.

Contact Us

If you have any problem or requirement when using our products or this manual, please contact **RIGOL**.

E-mail: service@rigol.com

Website: www.rigol.com

Safety Requirement

General Safety Summary

Please review the following safety precautions carefully before putting the instrument into operation so as to avoid any personal injury or damage to the instrument and any product connected to it. To prevent potential hazards, please follow the instructions specified in this manual to use the instrument properly.

Use Proper Power Cord.

Only the exclusive power cord designed for the instrument and authorized for use within the local country could be used.

Ground the Instrument.

The instrument is grounded through the Protective Earth lead of the power cord. To avoid electric shock, connect the earth terminal of the power cord to the Protective Earth terminal before connecting any input or output terminals.

Connect the Probe Correctly.

If a probe is used, the probe ground lead must be connected to earth ground. Do not connect the ground lead to high voltage. Improper way of connection could result in dangerous voltages being present on the connectors, controls or other surfaces of the oscilloscope and probes, which will cause potential hazards for operators.

Observe All Terminal Ratings.

To avoid fire or shock hazard, observe all ratings and markers on the instrument and check your manual for more information about ratings before connecting the instrument.

Use Proper Overvoltage Protection.

Ensure that no overvoltage (such as that caused by a bolt of lightning) can reach the product. Otherwise, the operator might be exposed to the danger of an electric shock.

Do Not Operate Without Covers.

Do not operate the instrument with covers or panels removed.

Do Not Insert Objects into the Air Outlet.

Do not insert objects into the air outlet, as doing so may cause damage to the instrument.

Use Proper Fuse.

Please use the specified fuses.

Avoid Circuit or Wire Exposure.

Do not touch exposed junctions and components when the unit is powered on.

Do Not Operate with Suspected Failures.

If you suspect that any damage may occur to the instrument, have it inspected by **RIGOL** authorized personnel before further operations. Any maintenance, adjustment or replacement especially to circuits or accessories must be performed by **RIGOL** authorized personnel.

Provide Adequate Ventilation.

Inadequate ventilation may cause an increase of temperature in the instrument, which would cause damage to the instrument. So please keep the instrument well ventilated and inspect the air outlet and the fan regularly.

Do Not Operate in Wet Conditions.

To avoid short circuit inside the instrument or electric shock, never operate the instrument in a humid

environment.

Do Not Operate in an Explosive Atmosphere.

To avoid personal injuries or damage to the instrument, never operate the instrument in an explosive atmosphere.

Keep Instrument Surfaces Clean and Dry.

To avoid dust or moisture from affecting the performance of the instrument, keep the surfaces of the instrument clean and dry.

Prevent Electrostatic Impact.

Operate the instrument in an electrostatic discharge protective environment to avoid damage induced by static discharges. Always ground both the internal and external conductors of cables to release static before making connections.

Use the Battery Properly.

Do not expose the battery (if available) to high temperature or fire.
Keep it out of the reach of children. Improper change of a battery (lithium battery) may cause an explosion.
Use the **RIGOL** specified battery only.

Handle with Caution.

Please handle with care during transportation to avoid damage to keys, knobs, interfaces, and other parts on the panels.

Safety Notices and Symbols

Safety Notices in this Manual:

**WARNING**

Indicates a potentially hazardous situation or practice which, if not avoided, will result in serious injury or death.

**CAUTION**

Indicates a potentially hazardous situation or practice which, if not avoided, could result in damage to the product or loss of important data.

Safety Terms on the Product:

DANGER It calls attention to an operation, if not correctly performed, could result in injury or hazard immediately.

WARNING It calls attention to an operation, if not correctly performed, could result in potential injury or hazard.

CAUTION It calls attention to an operation, if not correctly performed, could result in damage to the product or other devices connected to the product.

Safety Symbols on the Product:



Hazardous
Voltage



Safety
Warning



Protective
Earth
Terminal



Chassis
Ground



Test
Ground

Document Overview

This manual introduces how to program the RF signal generator over the remote interfaces in details.

Main Topics in this Manual:

Chapter 1 Programming Overview

This chapter outlines how to build the remote communication between the RF signal generator and PC and how to control the RF signal generator remotely. Besides, it also provides a brief introduction of the SCPI commands.

Chapter 2 Command System

This chapter introduces the syntax, function, parameter and using instruction of each DSG3000B command in alphabetical order (from A to Z).

Chapter 3 Application Examples

This chapter provides the application examples of the main functions of the RF signal generator. In the application examples, a series of commands are combined to realize the basic functions of the RF signal generator.

Chapter 4 Programming Demos

This chapter introduces how to program and control DSG3000B using development tools, such as Visual C++, Visual Basic and LabVIEW.

Chapter 5 Appendix

This chapter provides various information, such as factory setting list.

Tip

The latest version of this manual can be downloaded from www.rigol.com.

Format Conventions in this Manual:

1. Key

The key on the front panel is denoted by the format of "Key Name (Bold) + Text Box" in the manual. For example, **FREQ** denotes the **FREQ** key.

2. Menu

The menu items are denoted by the format of "Menu Word (Bold) + Character Shading". For example, **Frequency** denotes the "Frequency" menu item under **FREQ**.

3. Connector

The connectors on the front or rear panel are usually denoted by the format of "Connector Name (Bold) + Square Brackets (Bold)". For example, **[RF OUTPUT 50Ω]**.

4. Operation Predures

The next step of the operation is denoted by an arrow "→" in the manual. For example, **FREQ** → **Frequency** denotes pressing **FREQ** on the front panel first and then pressing **Frequency**.

Content Conventions in this Manual:

The DSG3000B series RF signal generator includes DSG3065B, DSG3065B-IQ, DSG3136B, and DSG3136B-IQ. This manual takes DSG3136B-IQ as an example to illustrate the functions and operation methods of DSG3000B series.

Model	RF Frequency Range	IQ Frequency Range
DSG3065B	9 kHz to 6.5 GHz	N/A
DSG3065B-IQ	9 kHz to 6.5 GHz	50 MHz to 6.5 GHz
DSG3136B	9 kHz to 13.6 GHz	N/A
DSG3136B-IQ	9 kHz to 13.6 GHz	50 MHz to 6.5 GHz

Contents

Guaranty and Declaration	I
Safety Requirement.....	II
General Safety Summary	II
Safety Notices and Symbols.....	IV
Document Overview	V
Chapter 1 Programming Overview.....	1-1
To Build Remote Communication	1-2
Remote Control Methods	1-3
SCPI Command Overview	1-3
Syntax.....	1-4
Symbol Description	1-4
Parameter Type.....	1-4
Command Abbreviation	1-5
Chapter 2 Command System.....	2-1
IEEE488.2 Common Commands.....	2-2
*IDN?	2-2
*TRG	2-2
:MMEMory Commands	2-3
:MMEMory:CATalog	2-3
:MMEMory:CATalog:LENGth	2-4
:MMEMory:COPI	2-4
:MMEMory:DATA:IQ:LIST	2-4
:MMEMory:DELeTe.....	2-5
:MMEMory:DISK:FORMat	2-5
:MMEMory:DISK:INFormation	2-5
:MMEMory:FILEtype	2-6
:MMEMory:LDISk:SPACe.....	2-6
:MMEMory:LOAD	2-6
:MMEMory:MDIRectory	2-6
:MMEMory:MOVE	2-7
:MMEMory:PNAME:EDIT	2-7
:MMEMory:PNAME:STATe.....	2-8
:MMEMory:SAVe.....	2-8
:OUTPut Command.....	2-9
:OUTPut[:STATe].....	2-9
:SOURce Commands.....	2-10
[:SOURce]:AM Command Subsystem.....	2-11
[:SOURce]:CORRection Command Subsystem	2-16
[:SOURce]:FM Command Subsystem	2-18
[:SOURce]:FMPM:TYPE.....	2-23
[:SOURce]:FREQuency Command Subsystem	2-24
[:SOURce]:INPut:TRIGger:SLOPe.....	2-26
[:SOURce]:IQ Command Subsystem	2-27
[:SOURce]:LEVel Command Subsystem	2-37
[:SOURce]:LFOutput Command Subsystem.....	2-41
[:SOURce]:MODulation:STATe.....	2-43
[:SOURce]:PHASe Command Subsystem	2-44
[:SOURce]:PM Command Subsystem	2-46
[:SOURce]:PULM Command Subsystem	2-51
[:SOURce]:SWEep Command Subsystem	2-60
:STATus Commands	2-74
:STATus:OPERation:CONDition	2-77

:STATus:OPERation:ENABLE	2-77
:STATus:OPERation[:EVENT]	2-77
:STATus:QUEStionable:CALibration:CONDition	2-78
:STATus:QUEStionable:CALibration:ENABLE	2-79
:STATus:QUEStionable:CALibration[:EVENT]	2-79
:STATus:QUEStionable:CONDition	2-79
:STATus:QUEStionable:CONNect:CONDition	2-80
:STATus:QUEStionable:CONNect:ENABLE	2-81
:STATus:QUEStionable:CONNect[:EVENT]	2-81
:STATus:QUEStionable:ENABLE	2-81
:STATus:QUEStionable[:EVENT]	2-82
:STATus:QUEStionable:FREQuency:CONDition	2-83
:STATus:QUEStionable:FREQuency:ENABLE	2-84
:STATus:QUEStionable:FREQuency[:EVENT]	2-84
:STATus:QUEStionable:MODulation:CONDition	2-85
:STATus:QUEStionable:MODulation:ENABLE	2-86
:STATus:QUEStionable:MODulation[:EVENT]	2-86
:STATus:QUEStionable:POWer:CONDition	2-87
:STATus:QUEStionable:POWer:ENABLE	2-88
:STATus:QUEStionable:POWer[:EVENT]	2-88
:STATus:QUEStionable:SELFtest:CONDition	2-89
:STATus:QUEStionable:SELFtest:ENABLE	2-90
:STATus:QUEStionable:SELFtest[:EVENT]	2-90
:STATus:QUEStionable:TEMP:CONDition	2-91
:STATus:QUEStionable:TEMP:ENABLE	2-92
:STATus:QUEStionable:TEMP[:EVENT]	2-92
:SYSTem Commands	2-93
:SYSTem:BRIGhtness	2-94
:SYSTem:CLear	2-94
:SYSTem:COMMunication:INTerface	2-94
:SYSTem:COMMunication:LAN:DHCP	2-95
:SYSTem:COMMunication:LAN:IP:ADDRESS	2-95
:SYSTem:COMMunication:LAN:IP:AUTO	2-96
:SYSTem:COMMunication:LAN:IP:GATeway	2-96
:SYSTem:COMMunication:LAN:IP:MANual	2-97
:SYSTem:COMMunication:LAN:IP:SET	2-97
:SYSTem:COMMunication:LAN:IP:SUBnet:MASK	2-97
:SYSTem:COMMunication:LAN:RESet	2-98
:SYSTem:COMMunication:LAN[:SELF]:PREFerred	2-98
:SYSTem:DATE	2-98
:SYSTem:DISPlay:UPDate[:STATe]	2-99
:SYSTem:FSWitch:STATe	2-99
:SYSTem:LANGUage	2-99
:SYSTem:LKEY	2-100
:SYSTem:POWer:ON:TYPE	2-100
:SYSTem:PRESet	2-101
:SYSTem:PRESet:TYPE	2-101
:SYSTem:PRESet:SAVE	2-101
:SYSTem:TIME	2-102
:SYSTem:TIME:STATe	2-102
:TRIGger Commands	2-103
:TRIGger:IQ[:IMMediate]	2-103
:TRIGger:PULSe[:IMMediate]	2-103
:TRIGger[:SWEep][:IMMediate]	2-103
:UNIT Command	2-104
:UNIT:POWer	2-104

Chapter 3 Application Examples 3-1

To Output RF signal	3-2
To Output RF Sweep Signal	3-2
To Output RF Modulated Signal.....	3-3
Chapter 4 Programming Demos.....	4-1
Programming Preparations	4-2
Excel Programming Demo	4-3
Matlab Programming Demo	4-7
LabVIEW Programming Demo.....	4-8
Visual Basic Programming Demo.....	4-12
Visual C++ Programming Demo	4-15
Chapter 5 Appendix	5-1
Appendix A: Factory Setting	5-1
Appendix B: Warranty	5-3

Chapter 1 Programming Overview

This chapter introduces how to build the remote communication between the instrument and PC and provides an overview of the syntax, abbreviation rules and status system of the SCPI commands.

Main topics of this chapter:

- ◆ [To Build Remote Communication](#)
- ◆ [Remote Control Methods](#)
- ◆ [SCPI Command Overview](#)

To Build Remote Communication

You can build the remote communication between DSG3000B and the PC via USB, LAN, or USB-GPIB interface.

Operating Steps:

1. Install the Ultra Sigma common PC software

Acquire the Ultra Sigma common PC software from www.rigol.com; then, install it according to the instructions.

2. Connect the instrument and PC and configure the interface parameters of the instrument

DSG3000B supports USB, LAN, and USB-GPIB communication interfaces, as shown in the figure below.

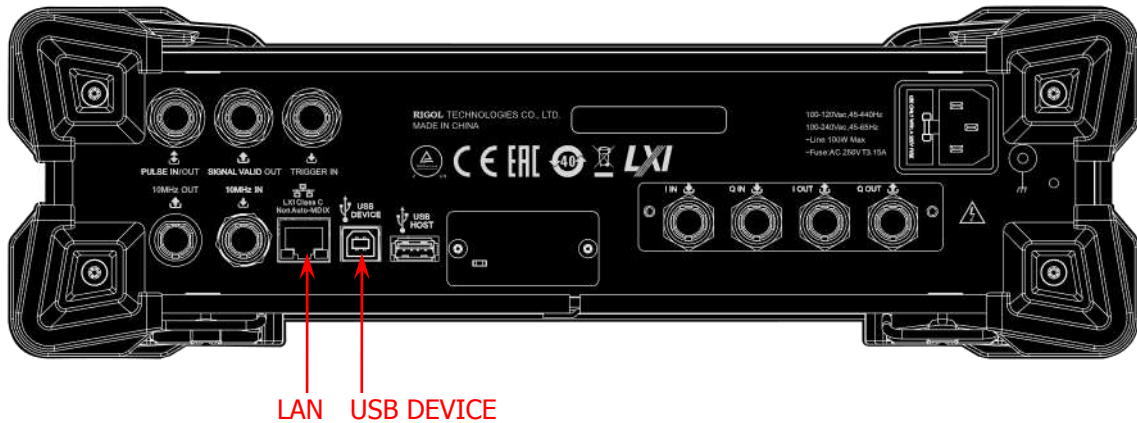

Figure 1-1 DSG3000B Communication Interfaces

- (1) Use the USB interface:

Connect the USB DEVICE interface on the rear panel of DSG3000B and the USB HOST interface of the PC using a USB cable.
- (2) Use the LAN interface:
 - Make sure that your PC is connected to the local network.
 - Check whether your local network supports DHCP or auto IP mode. If not, you need to acquire the network interface parameters available, including the IP address, subnet mask, gateway and DNS.
 - Connect DSG3000B to the local network using a network cable.
 - Press **System** → **I/O Config** → **LAN** to configure the IP address, subnet mask, gateway and DNS of the instrument.

3. Check whether the connection is successful

Start-up Ultra Sigma, search for the RF signal generator resource, right-click the resource name and select "SCPI Panel Control" from the pop-up menu. Enter the correct command in the pop-up SCPI control panel and click **Send Command**, **Read Response** or **Send&Read** to check whether the connection is successful, as shown in the figure on the next page (take the USB interface as an example).

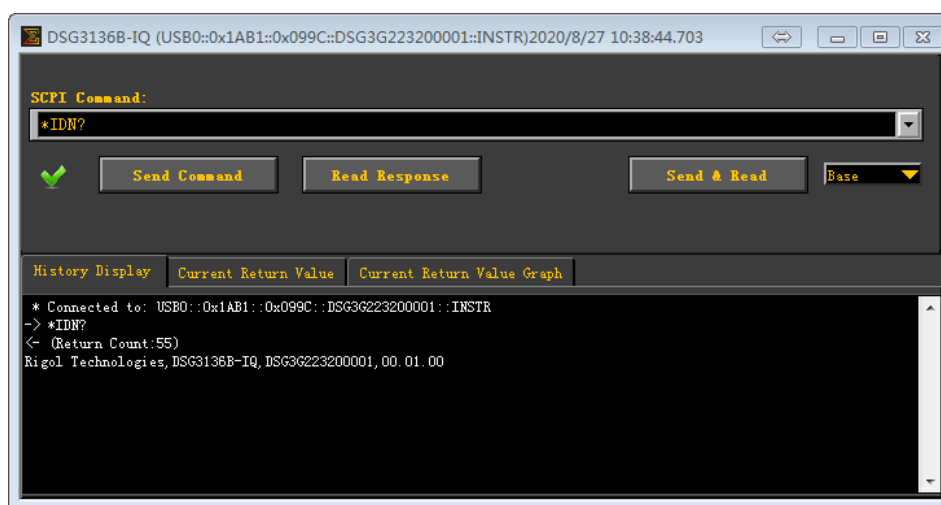
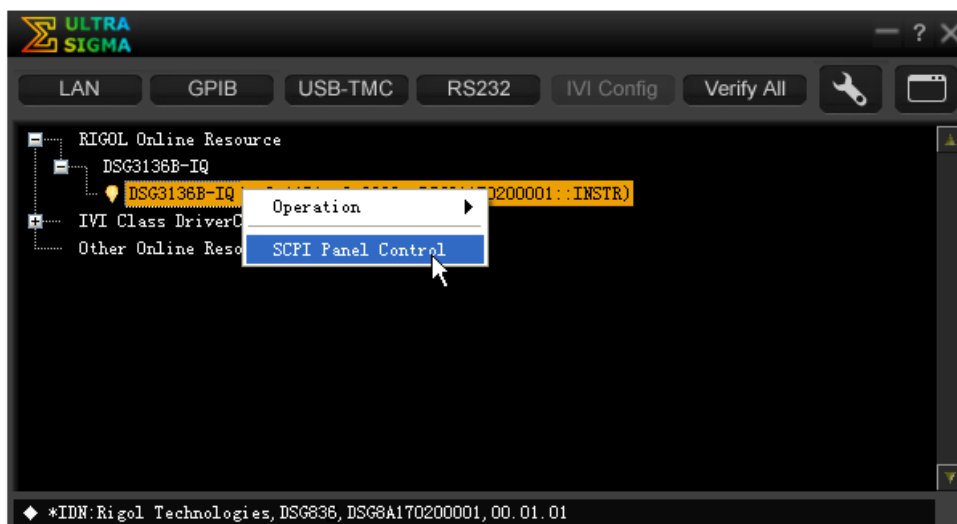

Remote Control Methods

1. User-defined programming

You can program and control DSG3000B using the SCPI (Standard Commands for Programmable Instruments) commands listed in Chapter 2 [Command System](#) in various development environments (such as Visual C++, Visual Basic and LabVIEW). For the details, refer to the introductions in Chapter 4 [Programming Demos](#).

2. Send SCPI commands via PC software

You can use the PC software Ultra Sigma (provided by **RIGOL**) to send SCPI commands to control the RF signal generator remotely.

SCPI Command Overview

SCPI (Standard Commands for Programmable Instruments) is a standardized instrument programming language that is based on the standard IEEE488.1 and IEEE488.2 and conforms to various standards (such as the floating point operation rule in IEEE754 standard, ISO646 7-bit coded character for information interchange (equivalent to ASCII programming)). This chapter describes the syntax, symbols, parameters and abbreviation rules of the SCPI commands.

Syntax

SCPI commands present a hierarchical tree structure and have multiple sub-systems, each of which contains a root keyword and one or more sub-keywords. The command string usually begins with ":"; the keywords are separated by ":" and are followed by the parameter settings available; "?" is added at the end of the command string to indicate query; space is used to separate the command and parameter.

For example,

```
:SYSTem:COMMunication:LAN:IP:ADDRESS <value>
:SYSTem:COMMunication:LAN:IP:ADDRESS?
```

SYSTem is the root keyword of the command above. COMMunication, LAN, IP and ADDRESS are the second-level, third-level, fourth-level and fifth-level keywords respectively. The command string begins with ":" which is also used to separate the multi-level keywords. <value> denotes the parameter available for setting. "?" denotes query and the RF signal generator returns the response information (the output value or internal setting value of the instrument) when receiving a query command. The command :SYSTem:COMMunication:LAN:IP:ADDRESS and parameter <value> are separated by a space.

"," is generally used for separating different parameters contained in the same command; for example, [:SOURce]:SWEep:LIST:LIST? <Start>,<Count>

Symbol Description

The following four symbols are not the content of SCPI commands and will not be sent with the command; but, they are usually used to describe the parameters in the commands.

1. Braces { }

Multiple optional parameters are enclosed in the braces and one of the parameters must be selected when sending the command.

2. Vertical Bar |

The vertical bar is used to separate multiple parameters. When you send a command, one of the parameters must be selected. For example, the :SYSTem:LANGUage CHINese|ENGLISH command.

3. Square Brackets []

The contents (command keywords) enclosed in the square brackets are optional and will be executed no matter whether they are omitted or not. For example, for the [:SOURce]:AM[:DEPTh]? command, sending any of the four commands below can generate the same effect.

```
:AM?
:AM:DEPTh?
:SOURce:AM?
:SOURce:AM:DEPTh?
```

4. Triangle Brackets < >

The parameter enclosed in the triangle brackets must be replaced by an effective value. For example, send the [:SOURce]:FREQUency <value> command in :FREQUency 4MHz form.

Parameter Type

The parameters of the commands introduced in this manual contains 5 types: bool, integer, real number, discrete and ASCII string.

1. Bool

The parameter could be OFF, ON, 0 or 1. For example, [:SOURce]:AM:STATe ON|OFF|1|0.

2. Integer

Unless otherwise noted, the parameter can be any integer within the effective value range. Note that do not set the parameter to a decimal; otherwise, errors will occur. For example, in the :SYSTEM:BRIGhtness <value> command, <value> can be any integer from 1 to 8.

3. Real Number

Unless otherwise noted, the parameter can be any value within the effective value range. For example, <value> in the [:SOURce]:AM:FREQuency <value> command can be any real number from 10Hz to 100kHz.

4. Discrete

The parameter could only be one of the specified values or characters. For example, in the [:SOURce]:AM:WAVEform SINE|SQUA command, the parameter can only be SINE or SQUA.

5. ASCII String

The parameter should be the combinations of ASCII characters. For example, in the :MMEMory:SAVE <file_name> command, <file_name> is the filename of the file to be saved and can include Chinese characters (a Chinese character occupies two bytes), English characters and numbers. The filename cannot exceed 28 bytes.

Command Abbreviation

All the commands are case-insensitive and you can use any of them. If abbreviation is used, all the capital letters in the command must be written completely. For example, the :MMEMory:DISK:FORMat command can be abbreviated to :MMEM:DISK:FORM.

Chapter 2 Command System

This chapter introduces the syntax, function, parameter and using instruction of each DSG3000B command in alphabetical (A to Z) order.

Main topics of this chapter:

- ◆ [IEEE488.2 Common Commands](#)
- ◆ [:MEMory Commands](#)
- ◆ [:OUTPut Command](#)
- ◆ [:SOURce Commands](#)
- ◆ [:STATus Commands](#)
- ◆ [:SYSTem Commands](#)
- ◆ [:TRIGger Commands](#)
- ◆ [:UNIT Command](#)

IEEE488.2 Common Commands

The IEEE488.2 common commands are used to query the basic information about the instrument or execute common operations. These commands usually begin with "*", contain a 3-character command keyword and relate to the status register.

Command List^[1]:

- ◆ [*IDN?](#)
- ◆ [*TRG](#)

*IDN?

Syntax *IDN?

Description Query the ID string of the instrument.

Return Format The query returns the ID string of the instrument. For example, Rigol Technologies,DSG3136B-IQ,DSG3G202008102,00.01.00.

*TRG

Syntax *TRG

Description Trigger a pulse modulation, RF sweep or IQ wavetable output immediately.

Related Commands [:TRIGger:IQ\[:IMMEDIATE\]](#)
[:TRIGger:PULSe\[:IMMEDIATE\]](#)
[:TRIGger\[:SWEep\]\[:IMMEDIATE\]](#)

Note^[1]: In the "Command List" in this manual, the parameters in the setting commands and the query commands are not included and you can refer to the complete introductions of the commands in the text according to the keywords.

:MMEMory Commands

The :MMEMory commands are used to store files to the internal or external memory of the instrument, read or delete the specified file as well as query the disk information.

Command List:

- ◆ [:MMEMory:CATalog](#)
- ◆ [:MMEMory:CATalog:LENGth](#)
- ◆ [:MMEMory:COPI](#)
- ◆ [:MMEMory:DATA:IQ:LIST](#)
- ◆ [:MMEMory:DELeTe](#)
- ◆ [:MMEMory:DISK:FORMat](#)
- ◆ [:MMEMory:DISK:INFormation](#)
- ◆ [:MMEMory:FILEtype](#)
- ◆ [:MMEMory:LDISk:SPACe](#)
- ◆ [:MMEMory:LOAD](#)
- ◆ [:MMEMory:MDIRectory](#)
- ◆ [:MMEMory:MOVE](#)
- ◆ [:MMEMory:PNAME:EDIT](#)
- ◆ [:MMEMory:PNAME:STATe](#)
- ◆ [:MMEMory:SAVE](#)

:MMEMory:CATalog

Syntax :MMEMory:CATalog? <path>

Description Query all the files and folders under the specified path.

Parameter	Name	Type	Range	Default
	<path>	ASCII string	Valid path	--

- Explanation**
- <path>: the local memory (D disk), external memory (E disk; when a USB storage device is detected by the USB HOST interface on the rear panel) or the subdirectory under the D or E disk.
 - The query returns a list of all the files and folders under the path specified by <path>.

Return Format NO.1 File Name: Rigol
NO.2 File Name: 4.STA

Example :MMEM:CAT? D:

:MMEMory:CATalog:LENGth

Syntax :MMEMory:CATalog:LENGth? <path>

Description Query the number of files and folders under the specified path.

Parameter	Name	Type	Range	Default
	<path>	ASCII string	Valid path	--

Explanation <path> can be the local memory (D disk), external memory (E disk; when a USB storage device is detected by the USB HOST interface on the rear panel) or the subdirectory under the D or E disk.

Return Format The query returns an integer. For example, 2.

Example :MMEM:CAT:LENG? D: /*Query and return the number of files and folders in the D disk*/

:MMEMory:COPI

Syntax :MMEMory:COPI <file_source>,<file_destination>

Description Copy the file or folder specified by <file_source> to the destination path specified by <file_destination>.

Parameter	Name	Type	Range	Default
	<file_source>	ASCII string	The name of the file or folder to be copied	--
	<file_destination>	ASCII string	Valid destination path	--

Explanation

- <file_source> denotes the file or folder to be copied. The file or folder name must contain the path. <file_destination> denotes the destination path and does not include the filename.
- If the file or folder specified by <file_source> does not exist, the operation fails.
- If the destination path specified by <file_destination> does not exist, the copy operation fails.

Example :MMEM:COPI D:\1.STA,D:\

:MMEMory:DATA:IQ:LIST

Syntax :MMEMory:DATA:IQ:LIST?

Description Query the wavetable files currently stored in the root directory (D: disk) of the instrument.

Return Format The query returns the wavetable file list in the format of "wavetable filename (*.arb),file size". For example, wave2.arb,2180,wave3.arb,2516,.

:MMEMory:DELeTe

Syntax :MMEMory:DELeTe <file_name>

Description Delete the specified file or folder under the specified operation path.

Parameter

Name	Type	Range	Default
<file_name>	ASCII string	The name of the file or folder to be deleted	--

Explanation

- This command is valid only when the specified file or folder exists under the current operation path or the specified path.
- <file_name> can be the name of a file or folder under the current operation path or a file or folder name containing the specified path. For example, :MMEM:DEL D:\NEW\8.STA.

Example :MMEM:DEL 8.STA /*Delete the file named "8.STA" under the current operation path*/

:MMEMory:DISK:FORMAt

Syntax :MMEMory:DISK:FORMAt

Description Format the local disk (D disk).

:MMEMory:DISK:INFormAtion

Syntax :MMEMory:DISK:INFormAtion? <Disk>

Description Query the information of the local disk.

Parameter

Name	Type	Range	Default
<Disk>	ASCII string	D: (or LOCAL)	D: (or LOCAL)

Return Format

The query returns the information of the local disk, including the disk name, file system, total space, used space and free space. For example,
 Disk:D: (or Disk:LOCAL)
 File Sys:FAT32
 Total:96.0 MB
 Used:768 KB
 Free:95.2 MB

Example :MMEM:DISK:INF? D: /*The query returns the information of D disk*/

:MMEMory:FILEtype

Syntax :MMEMory:FILEtype ALL|STATE|ARB|FLACsv|SWPCsv|TRNCsv
:MMEMory:FILEtype?

Description Set the file type.

Query the current file type.

Parameter

Name	Type	Range	Default
ALL STATE ARB FLACsv SWPCsv TRNCsv	Discrete	ALL STATE ARB FLACsv SWPCsv TRNCsv	ALL

- Explanation**
- The file types available are all, state, Arb, flatness csv, sweep csv, and train csv.
 - After selecting the corresponding file type, you can view all the files of this file type or save a new file of this file type.

Return Format The query returns ALL, STATE, ARB, FLACSV, SWPCSV, or TRNCsv.

Example :MMEM:FILE STATE /*Set the file type to "State"*/
:MMEM:FILE? /*Query the current file type and the query returns STATE*/

:MMEMory:LDISK:SPACE

Syntax :MMEMory:LDISK:SPACE?

Description Query the space information of the local disk (D disk).

Return Format The query returns the D disk space information including the "Used space" and "Free space". For example, Used:768 k,Free:97536 k.

:MMEMory:LOAD

Syntax :MMEMory:LOAD <file_name>

Description Read the specified file in the specified operation path.

Parameter

Name	Type	Range	Default
<file_name>	ASCII string	The name of the file to be read	--

- Explanation**
- This command is valid only when the specified file exists under the current operation path or the specified path.
 - <file_name> can be the name of a file under the current operation path or a file name containing the specified path. For example, MMEM:LOAD D:\NEW\2.STA.

Example :MMEM:LOAD 2.STA /*Read the file named "2.STA" under the current operation path*/

:MMEMory:MDIRECTory

Syntax :MMEMory:MDIRECTory <directory_name>

Description Create a new folder under the specified operation path.

Parameter	Name	Type	Range	Default
	<directory_name>	ASCII string	The name of the folder to be created	--

- Explanation**
- The folder name can include Chinese characters (a Chinese character occupies two bytes), English characters or numbers. The folder name cannot exceed 28 bytes.
 - If the name of the folder to be created already exists, this operation is invalid. At this point, "The filename already exists" is displayed in the user interface.
 - <directory_name> can be a new folder name that does not contain the path (denote creating a folder under the current operation path) or a folder name that contains the specified path (denote creating a new folder under the specified path; for example, :MMEM:MDIR D:\1\NEW).

Example :MMEM:MDIR NEW /*Create a folder named "NEW" under the current operation path*/

:MMEMory:MOVE

Syntax :MMEMory:MOVE <file_source>,<file_destination>

Description Rename the file or folder specified by <file_source> as the destination file or folder name specified by <file_destination>.

Parameter	Name	Type	Range	Default
	<file_source> <file_destination>	ASCII string	Valid file or folder name	--

- Explanation**
- The file or folder names specified by <file_source> and <file_destination> must contain the path.
 - If the file or folder specified by <file_source> does not exist, the rename operation fails.
 - If the destination file or folder name specified by <file_destination> already exists under the current path, the rename operation fails.

Example :MMEM:MOVE D:\1.STA, D:\2.STA

:MMEMory:PNAME:EDIT

Syntax :MMEMory:PNAME:EDIT <pre_name>

:MMEMory:PNAME:EDIT?

Description Edit and save the filename prefix.

Query the filename prefix saved.

Parameter	Name	Type	Range	Default
	<pre_name>	ASCII string	The filename prefix to be edited	--

Explanation You can edit any filename prefix.

Return Format The query returns the filename prefix. For example, N.

Example :MMEM:PNAM:EDIT N /*Edit the filename prefix as N*/
:MMEM:PNAM:EDIT? /*The query returns N*/

Related Command [:MMEMory:PNAME:STATE](#)

:MMEMory:PNAME:STATE

Syntax :MMEMory:PNAME:STATE ON|OFF|1|0
:MMEMory:PNAME:STATE?

Description Turn on or off the filename prefix.

Query the current on/off state of the filename prefix.

Parameter

Name	Type	Range	Default
ON OFF 1 0	Bool	ON OFF 1 0	OFF 0

- Explanation**
- ON|1: turn on the filename prefix edited.
 - OFF|0: turn off the filename prefix edited.
 - If the filename prefix is turned on, the prefix edited will be added to the filename input box automatically when saving a file.

Return Format The query returns 0 or 1.

Example :MMEM:PNAM:STATE ON
:MMEM:PNAM:STAT?

Related Command [:MMEMory:PNAME:EDIT](#)

:MMEMory:SAVE

Syntax :MMEMory:SAVE <File_name>

Description Save the file with the specified filename under the current operation path.

Parameter

Name	Type	Range	Default
<file_name>	ASCII string	The name of the file to be saved	--

- Explanation**
- The filename can include Chinese characters (a Chinese character occupies two bytes), English characters or numbers. The filename cannot exceed 28 bytes.
 - When the current path already contains a file with the same name, this command will directly overwrite the original file.

Example :MMEM:SAV SET.STA /*Save the current instrument state with the filename "SET.STA" under the current operation path*/

:OUTPut Command

Command List:

◆ [:OUTPut](#)

:OUTPut[:STATe]

Syntax :OUTPut[:STATe] ON|OFF|1|0
:OUTPut[:STATe]?

Description Turn on or off the RF output.

Query the on/off state of the RF output.

Parameter	Name	Type	Range	Default
	ON OFF 1 0	Bool	ON OFF 1 0	OFF 0

- Explanation**
- ON|1: turn on the RF output. At this point, the backlight of **RF** goes on.
 - OFF|0: turn off the RF output. At this point, the backlight of **RF** goes off.

Return Format The query returns 1 or 0.

Example :OUTP ON /*Turn on the RF output*/
:OUTP? /*The query returns 1*/

:SOURce Commands

The :SOURce commands are used to set the related parameters of the main functions of the RF signal generator including the frequency, level, flatness calibration, AM, FM/ØM, Pulse, SWEEP, LF output and so on.

Command List:

- ◆ [\[:SOURce\]:AM Command Subsystem](#)
- ◆ [\[:SOURce\]:CORRection Command Subsystem](#)
- ◆ [\[:SOURce\]:FM Command Subsystem](#)
- ◆ [\[:SOURce\]:FMpM:TYPE](#)
- ◆ [\[:SOURce\]:FREQuency Command Subsystem](#)
- ◆ [\[:SOURce\]:INPut:TRIGger:SLOPe](#)
- ◆ [\[:SOURce\]:IQ Command Subsystem](#)
- ◆ [\[:SOURce\]:LEVel Command Subsystem](#)
- ◆ [\[:SOURce\]:LFOutput Command Subsystem](#)
- ◆ [\[:SOURce\]:MODulation:STATe](#)
- ◆ [\[:SOURce\]:PHASe Command Subsystem](#)
- ◆ [\[:SOURce\]:PM Command Subsystem](#)
- ◆ [\[:SOURce\]:PULM Command Subsystem](#)
- ◆ [\[:SOURce\]:SWEEp Command Subsystem](#)

[:SOURce]:AM Command Subsystem

Command List:

- ◆ [\[:SOURce\]:AM:DEPTH](#)
- ◆ [\[:SOURce\]:AM:DEPTH:STEP\[:INCRement\]](#)
- ◆ [\[:SOURce\]:AM:EXT:COUP](#)
- ◆ [\[:SOURce\]:AM:EXT:IMP](#)
- ◆ [\[:SOURce\]:AM:FREQuency](#)
- ◆ [\[:SOURce\]:AM:FREQuency:STEP\[:INCRement\]](#)
- ◆ [\[:SOURce\]:AM:SOURce](#)
- ◆ [\[:SOURce\]:AM:STATe](#)
- ◆ [\[:SOURce\]:AM:WAVEform](#)

[:SOURce]:AM:DEPTH

Syntax [:SOURce]:AM:DEPTH <value>
[:SOURce]:AM:DEPTH?

Description Set the AM modulation depth.
Query the AM modulation depth.

Parameter

Name	Type	Range	Default
<value>	Real	0 to 100	50

- Explanation**
- When "Int" modulation source is selected, the AM modulation depth (m_a) and amplitude difference (ΔP_{sb}) between the carrier and sidebands satisfy the following relation: $\Delta P_{sb} = 6 - 20 \lg m_a$.
 - <value> can also be expressed as percentage. For example, 80%.
 - After the modulation depth is set, you can rotate the knob to modify the modulation depth at the current step. You can set and query the current step using the [\[:SOURce\]:AM:DEPTH:STEP\[:INCRement\]](#) command.

Return Format The query returns the modulation depth. For example, 80.00.

Example :AM:DEPT 80
:AM:DEPT?

Related Command [\[:SOURce\]:AM:DEPTH:STEP\[:INCRement\]](#)

[:SOURce]:AM:DEPTH:STEP[:INCRement]

Syntax [:SOURce]:AM:DEPTH:STEP[:INCRement] <value>
[:SOURce]:AM:DEPTH:STEP[:INCRement]?

Description Set the AM modulation depth step.
Query the AM modulation depth step.

Parameter	Name	Type	Range	Default
	<value>	Real	0.1 to 50	10

- Explanation**
- <value> can also be expressed as percentage. For example, 0.2%.
 - After the modulation depth step is set, you can rotate the knob to modify the modulation depth at the current step. At this point, you can query or set the modulation depth using the [\[:SOURce\]:AM:DEPT](#) command.

Return Format The query returns the modulation depth step. For example, 0.20.

Example AM:DEPT:STEP:INCR 0.2

AM:DEPT:STEP:INCR?

Related Command [\[:SOURce\]:AM:DEPT](#)

[:SOURce]:AM:EXT:COUP

Syntax [\[:SOURce\]:AM:EXT:COUP AC|DC](#)

[\[:SOURce\]:AM:EXT:COUP?](#)

Description Set the coupling mode of AM external modulation.

Query the coupling mode of AM external modulation.

Parameter	Name	Type	Range	Default
	AC DC	Discrete	AC DC	AC

- Explanation**
- AC: set the coupling mode of AM external modulation to "AC".
 - DC: set the coupling mode of AM external modulation to "DC".
 - When the modulation source of AM is set to "Int", this command is invalid.

Return Format The query returns AC or DC.

Example :AM:EXT:COUP AC

:AM:EXT:COUP?

Related Command [\[:SOURce\]:AM:SOURce](#)

[:SOURce]:AM:EXT:IMP

Syntax [\[:SOURce\]:AM:EXT:IMP 50|600|100k](#)

[\[:SOURce\]:AM:EXT:IMP?](#)

Description Set the impedance of AM external modulation.

Query the impedance of AM external modulation.

Parameter	Name	Type	Range	Default
	50 600 100k	Discrete	50 600 100k	100k

- Explanation**
- 50: set the impedance of AM external modulation to "50ohm".
 - 600: set the impedance of AM external modulation to "600ohm".
 - 100k: set the impedance of AM external modulation to "100kohm".
 - When the modulation source of AM is set to "Int", this command is invalid.

Return Format The query returns 50, 600 or 100k.

Example :AM:EXT:IMP 600
:AM:EXT:IMP?

Related Command [\[:SOURce\]:AM:SOURce](#)

[:SOURce]:AM:FREQuency

Syntax [:SOURce]:AM:FREQuency <value>
[:SOURce]:AM:FREQuency?

Description Set the AM modulation frequency.
Query the AM modulation frequency.

Parameter	Name	Type	Range	Default
	<value>	Real	10Hz to 100kHz (Sine)/10Hz to 20kHz (Square)	10kHz

- Explanation**
- When <value> is set in "Number" form, the default unit is Hz; for example, 20000. In addition, <value> can also be set in "Number + Unit" form; for example, 20kHz.
 - After the modulation frequency is set, you can rotate the knob to modify the modulation frequency at the current step. You can set and query the current step using the [\[:SOURce\]:AM:FREQuency:STEP\[:INCRement\]](#) command.
 - When the modulation source of AM is set to "Ext", this command is invalid.

Return Format The query returns the AM modulation frequency. For example, 20.00000kHz.

Example :AM:FREQ 20kHz
:AM:FREQ?

Related Commands [\[:SOURce\]:AM:FREQuency:STEP\[:INCRement\]](#)
[\[:SOURce\]:AM:SOURce](#)

[:SOURce]:AM:FREQuency:STEP[:INCRement]

Syntax [:SOURce]:AM:FREQuency:STEP[:INCRement] <value>
[:SOURce]:AM:FREQuency:STEP[:INCRement]?

Description Set the AM modulation frequency step.
Query the AM modulation frequency step.

Parameter	Name	Type	Range	Default
	<value>	Real	1Hz to 50kHz	1kHz

- Explanation**
- When <value> is set in "Number" form, the default unit is Hz. In addition, <value> can also be set in "Number + Unit" form; for example, 3.55kHz.
 - After the modulation frequency step is set, you can rotate the knob to modify the modulation frequency at the current step. At this point, you can query or set the modulation frequency using the [\[:SOURce\]:AM:FREQuency](#) command.

Return Format The query returns the AM modulation frequency step. For example, 3.55000kHz.

Example :AM:FREQ:STEP 3.55kHz

:AM:FREQ:STEP?

Related Command [\[:SOURce\]:AM:FREQuency](#)

[:SOURce]:AM:SOURce

Syntax [:SOURce]:AM:SOURce EXTernal|INTernal

[:SOURce]:AM:SOURce?

Description Set the AM modulation source.

Query the AM modulation source.

Parameter	Name	Type	Range	Default
	EXTernal INTernal	Discrete	EXTernal INTernal	INTernal

- Explanation**
- EXTernal: set the modulation source to "Ext". At this point, the external modulating signal is input from the **[EXT MOD INPUT]** connector.
 - INTernal: set the modulation source to "Int". At this point, the instrument provides the modulating signal and you can set the modulation frequency and modulation waveform of the modulating signal.

Return Format The query returns the AM modulation source. For example, EXT.

Example :AM:SOUR EXT

:AM:SOUR?

Related Commands [\[:SOURce\]:AM:FREQuency](#)
[\[:SOURce\]:AM:WAVEform](#)

[:SOURce]:AM:STATe

Syntax [:SOURce]:AM:STATe ON|OFF|1|0

[:SOURce]:AM:STATe?

Description Set the state of the AM switch.

Query the state of the AM switch.

Parameter	Name	Type	Range	Default
	ON OFF 1 0	Bool	ON OFF 1 0	OFF 0

- Explanation**
- ON|1: turn on the AM switch to enable the AM function.
 - OFF|0: turn off the AM switch to disable the AM function.

Return Format The query returns 1 or 0.

Example :AM:STAT ON /*Turn on the AM switch*/
 :AM:STAT? /*The query returns 1*/

[[:SOURce]:AM:WAVEform

Syntax [:SOURce]:AM:WAVEform SINE|SQUA
 [:SOURce]:AM:WAVEform?

Description Set the AM modulation waveform.
 Query the AM modulation waveform.

Parameter	Name	Type	Range	Default
	SINE SQUA	Discrete	SINE SQUA	SINE

Explanation

- SINE: set the AM modulation waveform to "Sine".
- SQUA: set the AM modulation waveform to "Square".
- When the modulation source of AM is set to "Ext", this command is invalid.

Return Format The query returns SINE or SQUA.

Example :AM:WAVE SQUA
 :AM:WAVE?

Related Command [\[:SOURce\]:AM:SOURce](#)

[:SOURce]:CORRection Command Subsystem

Command List:

- ◆ [\[:SOURce\]:CORRection:FLATness:COUNT](#)
- ◆ [\[:SOURce\]:CORRection:FLATness:LIST](#)
- ◆ [\[:SOURce\]:CORRection:FLATness\[:STATe\]](#)

[:SOURce]:CORRection:FLATness:COUNT

Syntax [:SOURce]:CORRection:FLATness:COUNT?

Description Query the number of points in the current flatness calibration list.

Return Format The query returns the number of points in the flatness calibration list in integer. For example, 5.

[:SOURce]:CORRection:FLATness:LIST

Syntax [:SOURce]:CORRection:FLATness:LIST? <Start>,<Count>

Description Query the flatness calibration list data within the specified range.

Parameter	Name	Type	Range	Default
	<Start>	Integer	1 to the total number of rows in the current list	--
	<Count>	Integer	1 to the total number of rows in the current list	--

- Explanation**
- <Start>: the number of the start row of the data to be acquired.
 - <Count>: the total number of rows of the data to be acquired.

Return Format The query returns the flatness calibration list data acquired. For example,
NO.1:304000000.000000 , 7.450000
NO.2:800000000.000000 , -17.799999

Example :CORR:FLAT:LIST? 2,2 /*Query and return two rows of calibration data starting from the 2nd row of the flatness calibration list*/

Related Command [\[:SOURce\]:CORRection:FLATness:COUNT](#)

[[:SOURce]:CORRection:FLATness[:STATe]]

Syntax [:SOURce]:CORRection:FLATness[:STATe] ON|OFF|1|0
[:SOURce]:CORRection:FLATness[:STATe]?

Description Turn on or off the flatness calibration switch.
Query the state of the flatness calibration switch.

Parameter

Name	Type	Range	Default
ON OFF 1 0	Bool	ON OFF 1 0	OFF 0

Explanation

- ON|1: turn on the flatness calibration switch.
- OFF|0: turn off the flatness calibration switch.

Return Format The query returns 1 or 0.

Example :CORR:FLAT ON /*Turn on the flatness calibration switch*/
:CORR:FLAT? /*The query returns 1*/

[:SOURce]:FM Command Subsystem

Command List:

- ◆ [\[:SOURce\]:FM:DEVIation](#)
- ◆ [\[:SOURce\]:FM:DEVIation:STEP\[:INCRement\]](#)
- ◆ [\[:SOURce\]:FM:EXT:COUP](#)
- ◆ [\[:SOURce\]:FM:EXT:IMP](#)
- ◆ [\[:SOURce\]:FM:FREQuency](#)
- ◆ [\[:SOURce\]:FM:FREQuency:STEP\[:INCRement\]](#)
- ◆ [\[:SOURce\]:FM:SOURce](#)
- ◆ [\[:SOURce\]:FM:STATe](#)
- ◆ [\[:SOURce\]:FM:WAVEform](#)

[:SOURce]:FM:DEVIation

Syntax [:SOURce]:FM:DEVIation <value>
[:SOURce]:FM:DEVIation?

Description Set the FM frequency deviation.

Query the FM frequency deviation.

Parameter

Name	Type	Range	Default
<value>	Real	100mHz to 1MHz	10kHz

- Explanation**
- When <value> is set in "Number" form, the default unit is Hz; for example, 20000. In addition, <value> can also be set in "Number + Unit" form; for example, 20kHz.
 - After the frequency deviation is set, you can rotate the knob to modify the deviation at the current step. You can set and query the current step using the [\[:SOURce\]:FM:DEVIation:STEP\[:INCRement\]](#) command.

Return Format The query returns the FM frequency deviation. For example, 20.00000kHz.

Example :FM:DEV 20kHz
:FM:DEV?

Related Command [\[:SOURce\]:FM:DEVIation:STEP\[:INCRement\]](#)

[[:SOURce]:FM:DEVIation:STEP[:INCRement]]

Syntax [:SOURce]:FM:DEVIation:STEP[:INCRement] <value>
[:SOURce]:FM:DEVIation:STEP[:INCRement]?

Description Set the FM frequency deviation step.
Query the FM frequency deviation step.

Parameter	Name	Type	Range	Default
	<value>	Real	10mHz to 500kHz	1kHz

Explanation

- When <value> is set in "Number" form, the default unit is Hz; for example, 5000. In addition, <value> can also be set in "Number + Unit" form; for example, 5kHz.
- After the frequency deviation step is set, you can rotate the knob to modify the deviation at the current step. At this point, You can query or set the current frequency deviation using the [\[:SOURce\]:FM:DEVIation](#) command.

Return Format The query returns the FM frequency deviation step. For example, 5.00000kHz.

Example :FM:STEP:INCR 5kHz
:FM:STEP:INCR?

Related Command [\[:SOURce\]:FM:DEVIation](#)

[[:SOURce]:FM:EXT:COUP]

Syntax [:SOURce]:FM:EXT:COUP AC|DC
[:SOURce]:FM:EXT:COUP?

Description Set the coupling mode of FM external modulation.
Query the coupling mode of FM external modulation.

Parameter	Name	Type	Range	Default
	AC DC	Discrete	AC DC	AC

Explanation

- AC: set the coupling mode of FM external modulation to "AC".
- DC: set the coupling mode of FM external modulation to "DC".
- When the modulation source of FM is set to "Int", this command is invalid.

Return Format The query returns AC or DC.

Example :FM:EXT:COUP AC
:FM:EXT:COUP?

Related Command [\[:SOURce\]:FM:SOURce](#)

[[:SOURce]:FM:EXT:IMP

Syntax [:SOURce]:FM:EXT:IMP 50|600|100k

[:SOURce]:FM:EXT:IMP?

Description Set the impedance of FM external modulation.

Query the impedance of FM external modulation.

Parameter

Name	Type	Range	Default
50 600 100k	Discrete	50 600 100k	100k

Explanation

- 50: set the impedance of FM external modulation to "50ohm".
- 600: set the impedance of FM external modulation to "600ohm".
- 100k: set the impedance of FM external modulation to "100kohm".
- When the modulation source of FM is set to "Int", this command is invalid.

Return Format The query returns 50, 600 or 100k.

Example :FM:EXT:IMP 600

:FM:EXT:IMP?

Related Command [\[:SOURce\]:FM:SOURce](#)

[[:SOURce]:FM:FREQuency

Syntax [:SOURce]:FM:FREQuency <value>

[:SOURce]:FM:FREQuency?

Description Set the FM modulation frequency.

Query the FM modulation frequency.

Parameter

Name	Type	Range	Default
<value>	Real	10Hz to 100kHz (Sine)/10Hz to 20kHz (Square)	10kHz

Explanation

- When <value> is set in "Number" form, the default unit is Hz; for example, 20000. In addition, <value> can also be set in "Number + Unit" form; for example, 20kHz.
- After the modulation frequency is set, you can rotate the knob to modify the modulation frequency at the current step. At this point, you can set and query the current step using the [\[:SOURce\]:FM:FREQuency:STEP\[:INCRement\]](#) command.
- When the modulation source of FM is set to "Ext", this command is invalid.

Return Format The query returns the FM modulation frequency. For example, 20.00000kHz.

Example :FM:FREQ 20kHz

:FM:FREQ?

Related Commands [\[:SOURce\]:FM:FREQuency:STEP\[:INCRement\]](#)
[\[:SOURce\]:FM:SOURce](#)

[[:SOURce]:FM:FREQuency:STEP[:INCRement]]

Syntax [:SOURce]:FM:FREQuency:STEP[:INCRement] <value>
[:SOURce]:FM:FREQuency:STEP[:INCRement]?

Description Set the FM modulation frequency step.

Query the FM modulation frequency step.

Parameter

Name	Type	Range	Default
<value>	Real	1Hz to 50kHz	1kHz

- Explanation**
- When <value> is set in "Number" form, the default unit is Hz; for example, 5000. In addition, <value> can also be set in "Number + Unit" form; for example, 5kHz.
 - After the modulation frequency step is set, you can rotate the knob to modify the modulation frequency at the current step. At this point, you can query or set the modulation frequency using the [\[:SOURce\]:FM:FREQuency](#) command.

Return Format The query returns the FM modulation frequency step. For example, 5.00000kHz.

Example :FM:FREQ:STEP 5kHz

:FM:FREQ:STEP?

Related Command [\[:SOURce\]:FM:FREQuency](#)

[[:SOURce]:FM:SOURce]

Syntax [:SOURce]:FM:SOURce EXTernal|INTernal
[:SOURce]:FM:SOURce?

Description Set the FM modulation source.

Query the FM modulation source.

Parameter

Name	Type	Range	Default
EXTernal INTernal	Discrete	EXTernal INTernal	INTernal

- Explanation**
- EXTernal: set the modulation source to "Ext". At this point, the external modulating signal is input from the **[EXT MOD INPUT]** connector.
 - INTernal: set the modulation source to "Int". At this point, the instrument provides the modulating signal and you can set the modulation frequency and modulation waveform of the modulating signal.

Return Format The query returns the FM modulation source. For example, INT.

Example :FM:SOUR INT

:FM:SOUR?

Related Commands [\[:SOURce\]:FM:FREQuency](#)
[\[:SOURce\]:FM:WAVEform](#)

[[:SOURce]:FM:STATe

Syntax [:SOURce]:FM:STATe ON|OFF|1|0
[:SOURce]:FM:STATe?

Description Set the state of the FM switch.
Query the state of the FM switch.

Parameter

Name	Type	Range	Default
ON OFF 1 0	Bool	ON OFF 1 0	OFF 0

Explanation

- ON|1: turn on the FM switch to enable the FM function.
- OFF|0: turn off the FM switch to disable the FM function.

Return Format The query returns 1 or 0.

Example :FM:STAT ON /*Turn on the FM switch*/
:FM:STAT? /*The query returns 1*/

[[:SOURce]:FM:WAVEform

Syntax [:SOURce]:FM:WAVEform SINE|SQUA
[:SOURce]:FM:WAVEform?

Description Set the FM modulation waveform.
Query the FM modulation waveform.

Parameter

Name	Type	Range	Default
SINE SQUA	Discrete	SINE SQUA	SINE

Explanation

- SINE: set the FM modulation waveform to "Sine".
- SQUA: set the FM modulation waveform to "Square".
- When the modulation source of FM is set to "Ext", this command is invalid.

Return Format The query returns SINE or SQUA.

Example :FM:WAVE SQUA
:FM:WAVE?

Related Command [\[:SOURce\]:FM:SOURce](#)

[[:SOURce]:FMPM:TYPE

Syntax [:SOURce]:FMPM:TYPE FM|PM

[:SOURce]:FMPM:TYPE?

Description Set the current modulation type to FM or ØM.

Query the current modulation type.

Parameter

Name	Type	Range	Default
FM PM	Discrete	FM PM	PM

- Explanation**
- FM: set the current modulation type to "FM".
 - PM: set the current modulation type to "ØM".

Return Format The query returns FM or PM.

Example :FMPM:TYPE FM

:FMPM:TYPE?

[:SOURce]:FREQuency Command Subsystem

Command List:

- ◆ [\[:SOURce\]:FREQuency](#)
- ◆ [\[:SOURce\]:FREQuency:OFFSet](#)
- ◆ [\[:SOURce\]:FREQuency:OFFSet:STEP](#)
- ◆ [\[:SOURce\]:FREQuency:STEP](#)

[:SOURce]:FREQuency

Syntax [:SOURce]:FREQuency <value>
[:SOURce]:FREQuency?

Description Set the frequency of the RF signal.
Query the frequency of the RF signal.

Parameter	Name	Type	Range	Default
	<value>	Real	9kHz to 13.6GHz	13.6GHz

- Explanation**
- When <value> is set in "Number" form, the default unit is Hz; for example, 4000000. In addition, <value> can also be set in "Number + Unit" form; for example, 4MHz.
 - After the RF frequency is set, you can rotate the knob to modify the frequency at the current step. At this point, you can set and query the current step using the [\[:SOURce\]:FREQuency:STEP](#) command.

Return Format The query returns the frequency of the RF signal. For example, 4.00000000MHz.

Example :FREQ 4MHz
:FREQ?

Related Command [\[:SOURce\]:FREQuency:STEP](#)
[\[:SOURce\]:FREQuency:OFFSet](#)

[:SOURce]:FREQuency:OFFSet

Syntax [:SOURce]:FREQuency:OFFSet <value>
[:SOURce]:FREQuency:OFFSet?

Description Set the RF frequency offset.
Query the RF frequency offset.

Parameter	Name	Type	Range	Default
	<value>	Real	-20GHz to 20GHz	0Hz

- Explanation**
- When <value> is set in "Number" form, the default unit is Hz, for example, 20000. In addition, <value> can also be set in "Number + Unit" form, for example, 20kHz.
 - The default unit of the return value is Hz.
 - After the RF frequency offset is set, you can use the up/down direction keys or knob to modify the offset at the current step. You can query or set the current

step using the [\[:SOURce\]:FREQuency:OFFSet:STEP](#) command.

- When the frequency offset is 0 Hz, the frequency displayed in the interface (namely the setting frequency) is equal to the actual output frequency.
- When the frequency offset is not 0 Hz, the output frequency is determined by the setting frequency and frequency offset. The three parameters satisfy the equation: setting frequency (display frequency) = output frequency + frequency offset. You can use the [\[:SOURce\]:FREQuency](#) command to query and set the RF frequency.

Return Format The query returns the RF frequency offset, for example, 20000.

Example :FREQ:OFFS 20kHz

:FREQ:OFFS?

Related Commands [\[:SOURce\]:FREQuency:OFFSet:STEP](#)
[\[:SOURce\]:FREQuency](#)

[:SOURce]:FREQuency:OFFSet:STEP

Syntax [\[:SOURce\]:FREQuency:OFFSet:STEP <value>](#)

[\[:SOURce\]:FREQuency:OFFSet:STEP?](#)

Description Set the RF frequency offset step.

Query the RF frequency offset step.

Parameter

Name	Type	Range	Default
<value>	Real	10mHz to 10GHz	100MHz

Explanation

- When <value> is set in "Number" form, the default unit is Hz, for example, 5000. In addition, <value> can also be set in "Number + Unit" form, for example, 5kHz.
- The default unit of the return value is Hz.
- After the frequency offset step is set, you can use the up/down direction keys or knob to modify the frequency offset at the current step. At this point, you can query or set the frequency offset using the [\[:SOURce\]:FREQuency:OFFSet](#) command.

Return Format The query returns the RF frequency offset step, for example, 5000.

Example :FREQ:OFFS:STEP 5kHz

:FREQ:OFFS:STEP?

Related Command [\[:SOURce\]:FREQuency:OFFSet](#)

[:SOURce]:FREQuency:STEP

Syntax [\[:SOURce\]:FREQuency:STEP <value>](#)

[\[:SOURce\]:FREQuency:STEP?](#)

Description Set the RF frequency step.

Query the RF frequency step.

Parameter	Name	Type	Range	Default
	<value>	Real	10mHz to 1GHz	100MHz

- Explanation**
- When <value> is set in "Number" form, the default unit is Hz; for example, 3000. In addition, <value> can also be set in "Number + Unit" form; for example, 3kHz.
 - After the RF frequency step is set, you can rotate the knob to modify the frequency at the current step. At this point, you can query or set the frequency using the [\[:SOURce\]:FREQuency](#) command.

Return Format The query returns the RF frequency step. For example, 3.00000kHz.

Example :FREQ:STEP 3kHz

:FREQ:STEP?

Related Command [\[:SOURce\]:FREQuency](#)

[:SOURce]:INPut:TRIGger:SLOPe

Syntax [:SOURce]:INPut:TRIGger:SLOPe POSitive|NEGative
[:SOURce]:INPut:TRIGger:SLOPe?

Description Set the polarity of the external trigger input signal.

Query the polarity of the external trigger input signal.

Parameter	Name	Type	Range	Default
	POSitive NEGative	Discrete	POSitive NEGative	POSitive

- Explanation**
- This command is valid only when the trigger mode of **SWEEP** is set to "Ext".
 - The external trigger signal is input from the **[TRIGGER IN]** connector on the rear panel.

Return Format The query returns POS or NEG.

Example :INP:TRIG:SLOP POS

:INP:TRIG:SLOP?

[[:SOURce]:IQ Command Subsystem

Command List^[1]:

- ◆ [\[:SOURce\]:IQ:BASeout:LEVel](#)
- ◆ [\[:SOURce\]:IQ:BASeout:LEVel:STEP](#)
- ◆ [\[:SOURce\]:IQ:BASeout:STATe](#)
- ◆ [\[:SOURce\]:IQ:MODE](#)
- ◆ [\[:SOURce\]:IQ:MODE:STATe](#)
- ◆ [\[:SOURce\]:IQ:SAMPlE](#)
- ◆ [\[:SOURce\]:IQ:SAMPlE:STEP](#)
- ◆ [\[:SOURce\]:IQ:TRIGger:ARB](#)
- ◆ [\[:SOURce\]:IQ:TRIGger:DELay](#)
- ◆ [\[:SOURce\]:IQ:TRIGger:DELay:STEP](#)
- ◆ [\[:SOURce\]:IQ:TRIGger:DURation](#)
- ◆ [\[:SOURce\]:IQ:TRIGger:DURation:STEP](#)
- ◆ [\[:SOURce\]:IQ:TRIGger:DURation:UNIT](#)
- ◆ [\[:SOURce\]:IQ:TRIGger:INHibit](#)
- ◆ [\[:SOURce\]:IQ:TRIGger:INHibit:STEP](#)
- ◆ [\[:SOURce\]:IQ:TRIGger:MODE](#)
- ◆ [\[:SOURce\]:IQ:TRIGger:OPTMode](#)

Note^[1]: IQ-related commands are only available for DSG3136B-IQ and DSG3065-IQ .

[[:SOURce]:IQ:BASeout:LEVel**Syntax** [[:SOURce]:IQ:BASeout:LEVel <value>

[[:SOURce]:IQ:BASeout:LEVel?

Description Set the baseband output amplitude.

Query the baseband output amplitude.

Parameter

Name	Type	Range	Default
<value>	Real	20mV to 1.5V	1V

- Explanation**
- When <value> is set in "Number" form, the default unit is V. Besides, <value> can also be set in "Number + Unit" form; for example, 1.1V.
 - The default unit of the return value is V.
 - After the baseband output amplitude is set, you can rotate the knob to modify the amplitude at the current step. At this point, you can set and query the current step using the [\[\[:SOURce\]:IQ:BASeout:LEVel:STEP](#) command.

Return Format The query returns the amplitude of the baseband output signal. For example, 1.100000.**Example** :IQ:BASeout:LEV 1.1

:IQ:BASeout:LEV?

Related Command [\[\[:SOURce\]:IQ:BASeout:LEVel:STEP](#)**[[:SOURce]:IQ:BASeout:LEVel:STEP****Syntax** [[:SOURce]:IQ:BASeout:LEVel:STEP <value>

[[:SOURce]:IQ:BASeout:LEVel:STEP?

Description Set the baseband output amplitude step.

Query the baseband output amplitude step.

Parameter

Name	Type	Range	Default
<value>	Real	0.01V to 0.5V	0.1V

- Explanation**
- When <value> is set in "Number" form, the default unit is V. Besides, <value> can also be set in "Number + Unit" form; for example, 0.2V.
 - The default unit of the return value is V.
 - After the baseband output amplitude step is set, you can rotate the knob to modify the baseband output amplitude at the current step. At this point, you can query or set the baseband output amplitude using the [\[\[:SOURce\]:IQ:BASeout:LEVel](#) command.

Return Format The query returns the baseband output amplitude step. For example, 0.200000.**Example** :IQ:BASeout:LEV:STEP 0.2

:IQ:BASeout:LEV:STEP?

Related Command [\[\[:SOURce\]:IQ:BASeout:LEVel](#)

[[:SOURce]:IQ:BASeout:STATe

Syntax [:SOURce]:IQ:BASeout:STATe ON|OFF|1|0
[:SOURce]:IQ:BASeout:STATe?

Description Set the state of the baseband output switch.

Query the state of the baseband output switch.

Parameter

Name	Type	Range	Default
ON OFF 1 0	Bool	ON OFF 1 0	OFF 0

- Explanation**
- ON|1: turn on the baseband output switch.
 - OFF|0: turn off the baseband output switch.

Return Format The query returns 1 or 0.

Example :IQ:BAS:STAT ON /*Turn on the baseband output switch*/
:IQ:BAS:STAT? /*The query returns 1*/

[[:SOURce]:IQ:MODE

Syntax [:SOURce]:IQ:MODE INternal|EXternal
[:SOURce]:IQ:MODE?

Description Set the IQ modulation source.

Query the IQ modulation source.

Parameter

Name	Type	Range	Default
INternal EXternal	Discrete	INternal EXternal	INTernal

- Explanation**
- INternal: select "Int" modulation source. At this point, the modulating signal is provided by the built-in baseband generator (wavetable) of the instrument. In addition, if the IQ modulation switch is turned on, the baseband output switch will be turned on automatically. The RF signal generator can output the I (In-Phase) components and Q (Quadrature Phase) components of the IQ modulation baseband signal from the **[I OUT]** and **[Q OUT]** connectors on the rear panel respectively.
 - EXternal: select "Ext" modulation source. At this point, the In-Phase and Quadrature Phase baseband signals of IQ modulation are input from the **[I IN]** and **[Q IN]** connectors on the rear panel respectively. In addition, when the baseband output switch is turned on, the In-Phase and Quadrature Phase components of the I/Q modulation baseband signal generated by the built-in baseband generator (wavetable) can be output from the **[I OUT]** and **[Q OUT]** connectors on the rear panel respectively.

Return Format The query returns the IQ modulation source. For example, INT.

Example :IQ:MOD INT
:IQ:MOD?

Related Command [\[:SOURce\]:IQ:BASeout:STATe](#)

[[:SOURce]:IQ:MODE:STATE

Syntax [:SOURce]:IQ:MODE:STATE ON|OFF|1|0

[:SOURce]:IQ:MODE:STATE?

Description Set the state of the IQ modulation switch.

Query the state of the IQ modulation switch.

Parameter

Name	Type	Range	Default
ON OFF 1 0	Bool	ON OFF 1 0	OFF 0

- Explanation**
- ON|1: enable the IQ modulation function.
 - OFF|0: disable the IQ modulation function.

Return Format The query returns 1 or 0.

Example :IQ:MOD:STAT ON /*Enable the IQ modulation function*/
:IQ:MOD:STAT? /*The query returns 1*/

[[:SOURce]:IQ:SAMPle

Syntax [:SOURce]:IQ:SAMPle <value>

[:SOURce]:IQ:SAMPle?

Description Set the sample rate of the IQ wavetable output.

Query the sample rate of the IQ wavetable output.

Parameter

Name	Type	Range	Default
<value>	Real	1kHz to 100MHz	1MHz

- Explanation**
- When <value> is set in "Number" form, the default unit is Hz; for example, 3000. In addition, <value> can also be set in "Number + Unit" form; for example, 3kHz.
 - The default unit of the return value is Hz.
 - After the sample rate is set, you can rotate the knob to modify the sample rate at the current step. At this point, you can set and query the current step using the [\[:SOURce\]:IQ:SAMPle:STEP](#) command.

Return Format The query returns the sample rate of the IQ wavetable output. For example, 3000.

Example :IQ:SAMP 3kHz
:IQ:SAMP?

Related Command [\[:SOURce\]:IQ:SAMPle:STEP](#)

[[:SOURce]:IQ:SAMPle:STEP**Syntax** [:SOURce]:IQ:SAMPle:STEP <value>

[:SOURce]:IQ:SAMPle:STEP?

Description Set the sample rate step of the IQ wavetable output.

Query the sample rate step of the IQ wavetable output.

Parameter

Name	Type	Range	Default
<value>	Real	1Hz to 10MHz	1MHz

- Explanation**
- When <value> is set in "Number" form, the default unit is Hz; for example, 3000. In addition, <value> can also be set in "Number + Unit" form; for example, 3kHz.
 - The default unit of the return value is Hz.
 - After the sample rate step of IQ wavetable output is set, you can rotate the knob to modify the sample rate at the current step. At this point, you can query or set the sample rate using the [\[:SOURce\]:IQ:SAMPle](#) command.

Return Format The query returns the sample rate step of the IQ wavetable output. For example, 3000.**Example** :IQ:SAMP:STEP 3kHz

:IQ:SAMP:STEP?

Related Command [\[:SOURce\]:IQ:SAMPle](#)**[[:SOURce]:IQ:TRIGger:ARB****Syntax** [:SOURce]:IQ:TRIGger:ARB**Description** Stop the waveform output manually.**Explanation** When the operation mode after the IQ wavetable is triggered is set to "Arm Auto" or "Arm Retrig", you need to use this command to stop the waveform output manually and wait for the next trigger.**Related Command** [\[:SOURce\]:IQ:TRIGger:OPTMode](#)

[[:SOURce]:IQ:TRIGger:DELay

Syntax [[:SOURce]:IQ:TRIGger:DELay <value>

[[:SOURce]:IQ:TRIGger:DELay?

Description Set the external trigger delay of the IQ modulation baseband signal.

Query the external trigger delay of the IQ modulation baseband signal.

Parameter

Name	Type	Range	Default
<value>	Integer	0 to 65535	0

- Explanation**
- The external delay refers to the delay of the response to a trigger when the external trigger signal is received.
 - This command is valid only when "Ext" trigger mode is selected. Wherein, <value> describes the number of points (N_d). The actual time (T_d) can be obtained according to the current sample rate (S_a): $T_d = N_d / S_a$.
 - After the trigger delay is set, you can rotate the knob to modify the delay at the current step. At this point, you can set and query the current step using the [\[:SOURce\]:IQ:TRIGger:DELay:STEP](#) command.

Return Format The query returns the external trigger delay. For example, 300.

Example :IQ:TRIG:DEL 300

:IQ:TRIG:DEL?

Related Commands [\[:SOURce\]:IQ:TRIGger:DELay:STEP](#)
[\[:SOURce\]:IQ:TRIGger:MODe](#)

[[:SOURce]:IQ:TRIGger:DELay:STEP

Syntax [[:SOURce]:IQ:TRIGger:DELay:STEP <value>

[[:SOURce]:IQ:TRIGger:DELay:STEP?

Description Set the external trigger delay step of the IQ modulation baseband signal.

Query the external trigger delay step of the IQ modulation baseband signal.

Parameter

Name	Type	Range	Default
<value>	Integer	1 to 10000	1

- Explanation** After the trigger delay step is set, you can rotate the knob to modify the trigger delay at the current step. At this point, you can query or set the trigger delay using the [\[:SOURce\]:IQ:TRIGger:DELay](#) command.

Return Format The query returns the external trigger delay step. For example, 20.

Example :IQ:TRIG:DEL:STEP 20

:IQ:TRIG:DEL:STEP?

Related Command [\[:SOURce\]:IQ:TRIGger:DELay](#)

[[:SOURce]:IQ:TRIGger:DURation**Syntax** [:SOURce]:IQ:TRIGger:DURation <value>

[:SOURce]:IQ:TRIGger:DURation?

Description Set the duration of the signal in single trigger.

Query the duration of the signal in single trigger.

Parameter

Name	Type	Range	Default
<value>	Integer	1 to 65535	1

Explanation

- This command is valid only when "Single" operation mode is selected. Wherein, <value> describes the number of points (N_r). The actual time (T_r) can be obtained according to the current sample rate (S_a): $T_r = N_r / S_a$.
- After the duration is set, you can rotate the knob to modify the duration at the current step. At this point, you can set and query the current step using the [\[:SOURce\]:IQ:TRIGger:DURation:STEP](#) command.

Return Format The query returns the duration of a single signal output. For example, 4000.**Example** :IQ:TRIG:DUR 4000

:IQ:TRIG:DUR?

Related Commands[\[:SOURce\]:IQ:TRIGger:DURation:STEP](#)[\[:SOURce\]:IQ:TRIGger:OPTMode](#)**[[:SOURce]:IQ:TRIGger:DURation:STEP****Syntax** [:SOURce]:IQ:TRIGger:DURation:STEP <value>

[:SOURce]:IQ:TRIGger:DURation:STEP?

Description Set the duration step.

Query the duration step.

Parameter

Name	Type	Range	Default
<value>	Integer	1 to 10000	1

Explanation

After the duration step is set, you can rotate the knob to modify the duration at the current step. At this point, you can query or set the duration using the [\[:SOURce\]:IQ:TRIGger:DURation](#) command.

Return Format The query returns the duration step. For example, 500.**Example** :IQ:TRIG:DUR:STEP 500

:IQ:TRIG:DUR:STEP?

Related Command[\[:SOURce\]:IQ:TRIGger:DURation](#)

[[:SOURce]:IQ:TRIGger:DURation:UNIT

Syntax [:SOURce]:IQ:TRIGger:DURation:UNIT SEQUENCE|SAMPLES
[:SOURce]:IQ:TRIGger:DURation:UNIT?

Description Set the duration unit of the IQ wavetable in "Single" trigger.
Query the duration unit of the IQ wavetable in "Single" trigger.

Parameter

Name	Type	Range	Default
SEQUENCE SAMPLES	Discrete	SEQUENCE SAMPLES	SAMPLES

Explanation

- SEQUENCE: trigger by the waveform segment.
- SAMPLES: trigger by the data point.

Return Format The query returns the duration unit of the IQ wavetable in "Single" trigger. For example, SAMPLES.

Example :IQ:TRIG:DUR:UNIT SAMPLES
:IQ:TRIG:DUR:UNIT?

Related Command [\[:SOURce\]:IQ:TRIGger:OPTMode](#)

[[:SOURce]:IQ:TRIGger:INHibit

Syntax [:SOURce]:IQ:TRIGger:INHibit <value>
[:SOURce]:IQ:TRIGger:INHibit?

Description Set the trigger inhibit of the IQ modulation baseband signal.
Query the trigger inhibit of the IQ modulation baseband signal.

Parameter

Name	Type	Range	Default
<value>	Integer	0 to 65535	0

Explanation

- Trigger inhibit refers to the time from when a trigger signal is received to when the instrument receives the next trigger signal.
- This command is valid only when "Ext" trigger mode is selected. <value> describes the number of points (N_i). The actual time (T_i) can be obtained according to the current sample rate (S_a): $T_i = N_i / S_a$.
- After the trigger inhibit is set, you can rotate the knob to modify the inhibit at the current step. At this point, you can set and query the current step using the [\[:SOURce\]:IQ:TRIGger:INHibit:STEP](#) command.

Return Format The query returns the trigger inhibit. For example, 5000.

Example :IQ:TRIG:INH 5000
:IQ:TRIG:INH?

Related Commands [\[:SOURce\]:IQ:TRIGger:INHibit:STEP](#)
[\[:SOURce\]:IQ:TRIGger:MODE](#)

[[:SOURce]:IQ:TRIGger:INHibit:STEP

Syntax [:SOURce]:IQ:TRIGger:INHibit:STEP <value>
[:SOURce]:IQ:TRIGger:INHibit:STEP?

Description Set the trigger inhibit step.

Query the trigger inhibit step.

Parameter

Name	Type	Range	Default
<value>	Integer	1 to 10000	1

Explanation After the trigger inhibit step is set, you can rotate the knob to modify the trigger inhibit at the current step. At this point, you can query or set the trigger inhibit using the [\[:SOURce\]:IQ:TRIGger:INHibit](#) command.

Return Format The query returns the trigger inhibit step. For example, 555.

Example :IQ:TRIG:INH:STEP 555
:IQ:TRIG:INH:STEP?

Related Command [\[:SOURce\]:IQ:TRIGger:INHibit](#)

[[:SOURce]:IQ:TRIGger:MODE

Syntax [:SOURce]:IQ:TRIGger:MODE AUTO|KEY|BUS|EXT
[:SOURce]:IQ:TRIGger:MODE?

Description Set the trigger mode of the IQ modulation baseband output.

Query the trigger mode of the IQ modulation baseband output.

Parameter

Name	Type	Range	Default
AUTO KEY BUS EXT	Discrete	AUTO KEY BUS EXT	AUTO

Explanation

- AUTO: select "Auto" trigger mode. At this point, the RF signal generator fulfills the trigger condition at any time and will output the IQ baseband signal continuously.
- KEY: select "Key" trigger mode. The instrument will output the baseband signal each time **Trigger** on the front panel is pressed.
- BUS: select "Bus" trigger mode. At this point, the instrument will output the baseband signal each time the [*TRG](#) or [:TRIGger:IQ\[:IMMediate\]](#) command is sent.
- EXT: select "Ext" trigger mode. At this point, the RF signal generator receives the external trigger signal input from the **[TRIGGER IN]** connector on the rear panel. The instrument will output the baseband signal each time a TTL pulse with the specified polarity is received.
- When "Ext" trigger mode is selected, you can also set the "Ext Delay" and "Ext Inhibit".

Return Format The query returns the trigger mode of the IQ modulation baseband output. For example, KEY.

Example :IQ:TRIG:MOD KEY
:IQ:TRIG:MOD?

Related Commands [\[:SOURce\]:IQ:TRIGger:DElay](#)
[\[:SOURce\]:IQ:TRIGger:INHibit](#)
[*TRG](#)
[:TRIGger:IQ\[:IMMediate\]](#)

[:SOURce]:IQ:TRIGger:OPTMode

Syntax [\[:SOURce\]:IQ:TRIGger:OPTMode RETRig|AMDAuto|AMDRe trig|SINGle](#)
[\[:SOURce\]:IQ:TRIGger:OPTMode?](#)

Description Set the operation mode after the IQ modulation baseband signal is triggered.
 Query the operation mode after the IQ modulation baseband signal is triggered.

Parameter	Name	Type	Range	Default
	RETRig AMDAuto AMDRe trig SINGle	Discrete	RETRig AMDAuto AMDRe trig SINGle	RETRig

Explanation

- RETRig: select the "Retrig" mode. At this point, the instrument outputs the baseband signal continuously and restarts to output the signal each time a trigger is received.
- AMDAuto: select the "Arm Auto" mode. The instrument starts outputting the waveform continuously each time a trigger is received until "Arm ARB" is selected and then waits for the next trigger.
- AMDRe trig: select the "Arm Retrig" mode. The instrument starts outputting the waveform continuously each time a trigger is received; the instrument restarts outputting the signal when another trigger is received until "Arm ARB" is selected and then waits for the next trigger.
- SINGle: select the "Single" mode. The instrument outputs the specified length (specified in "Duration") of waveform each time a trigger is received and then stops to wait for the next trigger.

Return Format The query returns the operation mode after the IQ modulation baseband signal is triggered. For example, RETRIG.

Example [:IQ:TRIG:OPTM RETR](#)
[:IQ:TRIG:OPTM?](#)

Related Commands [\[:SOURce\]:IQ:TRIGger:ARB](#)
[\[:SOURce\]:IQ:TRIGger:DURation](#)

[:SOURce]:LEVel Command Subsystem

Command List:

- ◆ [\[:SOURce\]:LEVel](#)
- ◆ [\[:SOURce\]:LEVel:STEP](#)
- ◆ [\[:SOURce\]:LEVel:LIMit](#)
- ◆ [\[:SOURce\]:LEVel:LIMit:STEP](#)
- ◆ [\[:SOURce\]:LEVel:OFFSet](#)
- ◆ [\[:SOURce\]:LEVel:OFFSet:STEP](#)

[:SOURce]:LEVel

Syntax [:SOURce]:LEVel <value>

[:SOURce]:LEVel?

Description Set the RF output amplitude.

Query the RF output amplitude.

Parameter	Name	Type	Range	Default
	<value>	Real	-130dBm to 27dBm	-110dBm

- Explanation**
- When <value> is set in "Number" form (for example, 2), the default unit is dBm. In addition, <value> can also be set in "Number + Unit" form (for example, 2dBm); at this point, the amplitude displayed in the RF signal generator interface is related to the setting of **Level Unit**.
 - When the level unit is "dBm", 2.00dBm is displayed;
 - When the level unit is "dBmV", 48.99dBmV is displayed;
 - When the level unit is "dBuV", 108.99dBuV is displayed;
 - When the level unit is "Volts", 281.50mV is displayed;
 - When the level unit is "Watts", 1.58mW is displayed.
 - The default unit of the return value is dBm.
 - After the RF output amplitude is set, you can rotate the knob to modify the amplitude at the current step. At this point, you can set and query the current step using the [\[:SOURce\]:LEVel:STEP](#) command.

Return Format The query returns the RF output amplitude. For example, 2.00.

Example :LEV 2dBm /*Set the amplitude of the RF signal to 2dBm*/
 :LEV? /*Query the amplitude of the RF signal and the query returns 2.00*/

Related Command [\[:SOURce\]:LEVel:STEP](#)

[[:SOURce]:LEVel:STEP

Syntax [:SOURce]:LEVel:STEP <value>

[:SOURce]:LEVel:STEP?

Description Set the RF output amplitude step.

Query the RF output amplitude step.

Parameter

Name	Type	Range	Default
<value>	Real	0.01dB to 100dB	10dB

- Explanation**
- When <value> is set in "Number" form, the default unit is dB. Besides, <value> can also be set in "Number + Unit" form; for example, 20dB.
 - The default unit of the return value is dB.
 - After the output amplitude step is set, you can rotate the knob to modify the output amplitude at the current step. At this point, you can query or set the output amplitude using the [\[:SOURce\]:LEVel](#) command.

Return Format The query returns the RF output amplitude step. For example, 20.00.

Example :LEV:STEP 20

:LEV:STEP?

Related Command [\[:SOURce\]:LEVel](#)

[[:SOURce]:LEVel:LIMit

Syntax [:SOURce]:LEVel:LIMit <value>

[:SOURce]:LEVel:LIMit?

Description Set the limit of the RF output amplitude.

Query the limit of the RF output amplitude.

Parameter

Name	Type	Range	Default
<value>	Real	-130dBm to 27dBm	20dBm

- Explanation**
- When <value> is set in "Number" form (for example, 2), the default unit is dBm. When it is set in "Number + Unit" form (for example, 2dBm), the limit displayed in the RF signal generator interface is related to the setting of **Level Unit**.
 - When the level unit is "dBm", it is displayed as 2.00dBm;
 - When the level unit is "dBmV", it is displayed as 48.99dBmV;
 - When the level unit is "dBuV", it is displayed as 108.99dBuV;
 - When the level unit is "Volts", it is displayed as 281.50mV;
 - When the level unit is "Watts", it is displayed as 1.58mW.
 - The default unit of all the return values is dBm.
 - After setting the amplitude limit, you can use the up/down direction keys or knob to modify the limit at the current step. At this point, you can query or set the current step using the [\[:SOURce\]:LEVel:LIMit:STEP](#) command.

Return Format The query returns the limit of the RF output amplitude, for example, 5.60.

Example :LEV:LIM 5.6

:LEV:LIM?

Related Command [\[:SOURce\]:LEVel:LIMit:STEP](#)

[:SOURce]:LEVel:LIMit:STEP

Syntax [:SOURce]:LEVel:LIMit:STEP <value>

[:SOURce]:LEVel:LIMit:STEP?

Description Set the step of the RF output amplitude limit.

Query the step of the RF output amplitude limit.

Parameter	Name	Type	Range	Default
	<value>	Real	0.01dB to 100dB	10dB

- Explanation**
- When <value> is set in "Number" form, the default unit is dB. Besides, <value> can also be set in "Number + Unit" form, for example, 4.5dB.
 - The default unit of the return value is dB.
 - After setting the step of the amplitude limit, you can use the up/down direction keys or knob to modify the limit at the current step. At this point, you can query or set the amplitude limit using the [\[:SOURce\]:LEVel:LIMit](#) command.

Return Format The query returns the step of the RF output amplitude limit, for example, 4.50.

Example :LEV:LIM:STEP 4.5

:LEV:LIM:STEP?

Related Command [\[:SOURce\]:LEVel:LIMit](#)

[:SOURce]:LEVel:OFFSet

Syntax [:SOURce]:LEVel:OFFSet <value>

[:SOURce]:LEVel:OFFSet?

Description Set the amplitude offset of the RF output amplitude.

Query the amplitude offset of the RF output amplitude.

Parameter	Name	Type	Range	Default
	<value>	Real	-200dB to 200dB	0dB

- Explanation**
- When <value> is set in "Number" form, the default unit is dB. Besides, <value> can also be set in "Number + Unit" form, for example, 10dB.
 - The default unit of the return value is dB.
 - After setting the amplitude offset, you can use the up/down direction keys or knob to modify the amplitude offset at the current step. At this point, you can query or set the current step using the [\[:SOURce\]:LEVel:OFFSet:STEP](#) command.
 - When the amplitude offset is 0 dB, the display amplitude (namely the setting amplitude) is equal to the actual output amplitude.

- When the amplitude offset is not 0 dB, the output amplitude is determined by the setting amplitude and amplitude offset. The three parameters satisfy the equation: setting amplitude (display amplitude) = output amplitude + amplitude offset. You can query or set the RF amplitude using the [\[:SOURce\]:LEVel](#) command.

Return Format The query returns the offset of the RF output amplitude, for example, 10.00.

Example :LEV:OFFS 10

:LEV:OFFS?

Related Commands [\[:SOURce\]:LEVel:OFFSet:STEP](#)
[\[:SOURce\]:LEVel](#)

[\[:SOURce\]:LEVel:OFFSet:STEP](#)

Syntax [\[:SOURce\]:LEVel:OFFSet:STEP <value>](#)

[\[:SOURce\]:LEVel:OFFSet:STEP?](#)

Description Set the step of the RF amplitude offset.

Query the step of the RF amplitude offset.

Parameter	Name	Type	Range	Default
	<value>	Real	0.01dB to 200dB	10dB

- Explanation**
- When <value> is set in "Number" form, the default unit is dB. Besides, <value> can also be set in "Number + Unit" form, for example, 20dB.
 - The default unit of the return value is dB.
 - After setting the step of the amplitude offset, you can use the up/down direction keys or knob to modify the amplitude offset at the current step. At this point, you can query or set the amplitude offset using the [\[:SOURce\]:LEVel:OFFSet](#) command.

Return Format The query returns the step of the RF amplitude offset, for example, 20.00.

Example :LEV:OFFS:STEP 20

:LEV:OFFS:STEP?

Related Command [\[:SOURce\]:LEVel:OFFSet](#)

[[:SOURce]:LFOutput Command Subsystem

Command List:

- ◆ [\[:SOURce\]:LFOutput:FREQuency](#)
- ◆ [\[:SOURce\]:LFOutput:LEVel](#)
- ◆ [\[:SOURce\]:LFOutput:SHAPE](#)
- ◆ [\[:SOURce\]:LFOutput\[:STATe\]](#)

[[:SOURce]:LFOutput:FREQuency

Syntax [:SOURce]:LFOutput:FREQuency <value>
[:SOURce]:LFOutput:FREQuency?

Description Set the frequency of the LF output signal.
Query the frequency of the LF output signal.

Parameter	Name	Type	Range	Default
	<value>	Real	0Hz to 200kHz (Sine)/0Hz to 20kHz (Square)	1kHz

Explanation When <value> is set in "Number" form, the default unit is Hz. Besides, <value> can also be set in "Number + Unit" form; for example, 2kHz.

Return Format The query returns the frequency of the LF output signal. For example, 2.00000kHz.

Example :LFO:FREQ 2kHz
:LFO:FREQ?

[[:SOURce]:LFOutput:LEVel

Syntax [:SOURce]:LFOutput:LEVel <value>
[:SOURce]:LFOutput:LEVel?

Description Set the amplitude of the LF output signal.
Query the amplitude of the LF output signal.

Parameter	Name	Type	Range	Default
	<value>	Real	0V to 3V	500mV

Explanation ➤ When <value> is set in "Number" form, the default unit is V. Besides, <value> can also be set in "Number + Unit" form; for example, 2V.
➤ The default unit of the return value is V.

Return Format The query returns the amplitude of the LF output signal. For example, 2.00.

Example :LFO:LEV 2
:LFO:LEV?

[[:SOURce]:LFOOutput:SHAPE]

Syntax [:SOURce]:LFOOutput:SHAPE SINE|SQUare
[:SOURce]:LFOOutput:SHAPE?

Description Set the waveform of the LF output signal.
Query the waveform of the LF output signal.

Parameter	Name	Type	Range	Default
	SINE SQUare	Discrete	SINE SQUare	SINE

Explanation ➤ SINE: set the waveform of the LF output signal to "Sine".
➤ SQUare: set the waveform of the LF output signal to "Square".

Return Format The query returns SINE|SQU.

Example :LFO:SHAP SINE
:LFO:SHAP?

[[:SOURce]:LFOOutput[:STATE]]

Syntax [:SOURce]:LFOOutput[:STATE] ON|OFF|1|0
[:SOURce]:LFOOutput[:STATE]?

Description Turn on or off the LF output switch.
Query the state of the LF output switch.

Parameter	Name	Type	Range	Default
	ON OFF 1 0	Bool	ON OFF 1 0	OFF 0

Explanation ➤ ON|1: turn on the LF output switch.
➤ OFF|0: turn off the LF output switch.

Return Format The query returns 1 or 0.

Example :LFO:STAT ON /*Turn on the LF output switch*/
:LFO:STAT? /*The query returns 1*/

[[:SOURce]:MODulation:STATe

Syntax [:SOURce]:MODulation:STATe ON|OFF|1|0

[:SOURce]:MODulation:STATe?

Description Turn on or off the switch of all the modulation outputs.

Query the on/off state of the switch of all the modulation outputs.

Parameter

Name	Type	Range	Default
ON OFF 1 0	Bool	ON OFF 1 0	OFF 0

- Explanation**
- ON|1: turn on all the modulation outputs. The backlight of **Mod** goes on.
 - OFF|0: turn off all the modulation outputs. The backlight of **Mod** goes off.

Return Format The query returns 1 or 0.

Example :MOD:STAT ON /*Turn on the switch of all the modulation outputs*/

:MOD:STAT? /*The query returns 1*/

[:SOURce]:PHASe Command Subsystem

Command List:

- ◆ [\[:SOURce\]:PHASe](#)
- ◆ [\[:SOURce\]:PHASe:RESet](#)
- ◆ [\[:SOURce\]:PHASe:STEP\[:INCRement\]](#)

[:SOURce]:PHASe

Syntax [:SOURce]:PHASe <value>

[:SOURce]:PHASe?

Description Set the phase offset of RF output.

Query the phase offset of RF output.

Parameter	Name	Type	Range	Default
	<value>	Real	-720deg to 720deg	0deg

- Explanation**
- When <value> is set in "Number" form, the default unit is deg. Besides, <value> can also be set in "Number + Unit" form, for example, 35deg.
 - The default unit of the return value is deg.
 - After setting the RF phase offset, you can use the up/down direction keys or knob to modify the phase offset at the current step. At this point, you can query or set the current step using the [\[:SOURce\]:PHASe:STEP\[:INCRement\]](#) command.

Return Format The query returns the phase offset of RF output, for example, 35.000000.

Example :PHAS 35

:PHAS?

Related Command [\[:SOURce\]:PHASe:STEP\[:INCRement\]](#)

[:SOURce]:PHASe:RESet

Syntax [:SOURce]:PHASe:RESet

Description Reset the current phase offset to 0deg.

Related Command [\[:SOURce\]:PHASe](#)

[:SOURce]:PHASe:STEP[:INCRement]

Syntax [:SOURce]:PHASe:STEP[:INCRement] <value>

[:SOURce]:PHASe:STEP[:INCRement]?

Description Set the phase offset step of RF output.

Query the phase offset step of RF output.

Parameter	Name	Type	Range	Default
	<value>	Real	0.01deg to 180deg	1deg

- Explanation**
- When <value> is set in "Number" form, the default unit is deg. Besides, <value> can also be set in "Number + Unit" form, for example, 5deg.
 - The default unit of the return value is deg.
 - After setting the phase offset step, you can use the up/down direction keys or knob to modify the phase offset at the current step. At this point, you can query or set the phase offset using the [\[:SOURce\]:PHASe](#) command.

Return Format The query returns the phase offset step, for example, 5.000000.

Example :PHAS:STEP 5

:PHAS:STEP?

Related Command [\[:SOURce\]:PHASe](#)

[:SOURce]:PM Command Subsystem

Command List:

- ◆ [\[:SOURce\]:PM:DEVIation](#)
- ◆ [\[:SOURce\]:PM:DEVIation:STEP\[:INCRement\]](#)
- ◆ [\[:SOURce\]:PM:EXT:COUP](#)
- ◆ [\[:SOURce\]:PM:EXT:IMP](#)
- ◆ [\[:SOURce\]:PM:FREQuency](#)
- ◆ [\[:SOURce\]:PM:FREQuency:STEP\[:INCRement\]](#)
- ◆ [\[:SOURce\]:PM:SOURce](#)
- ◆ [\[:SOURce\]:PM:STATe](#)
- ◆ [\[:SOURce\]:PM:WAVEform](#)

[:SOURce]:PM:DEVIation

Syntax [:SOURce]:PM:DEVIation <value>
[:SOURce]:PM:DEVIation?

Description Set the phase deviation of ØM.
Query the phase deviation of ØM.

Parameter	Name	Type	Range	Default
	<value>	Real	0rad to 5rad	5rad

- Explanation**
- When <value> is set in "Number" form, the default unit is rad. Besides, <value> can also be set in "Number + Unit" form; for example, 2rad.
 - The default unit of the return value is rad.
 - After the phase deviation is set, you can rotate the knob to modify the phase deviation at the current step. At this point, you can query and set the current step using the [\[:SOURce\]:PM:DEVIation:STEP\[:INCRement\]](#) command.

Return Format The query returns the phase deviation of ØM. For example, 2.000000.

Example :PM:DEV 2
:PM:DEV?

Related Command [\[:SOURce\]:PM:DEVIation:STEP\[:INCRement\]](#)

[[:SOURce]:PM:DEVIation:STEP[:INCRement]]

Syntax [:SOURce]:PM:DEVIation:STEP[:INCRement] <value>
[:SOURce]:PM:DEVIation:STEP[:INCRement]?

Description Set the phase deviation step of ØM.

Query the phase deviation step of ØM.

Parameter

Name	Type	Range	Default
<value>	Real	0.01rad to 2.5rad	1rad

- Explanation**
- When <value> is set in "Number" form, the default unit is rad. Besides, <value> can also be set in "Number + Unit" form; for example, 1rad.
 - The default unit of the return value is rad.
 - After the phase deviation step is set, you can rotate the knob to modify the phase deviation at the current step. At this point, you can query or set the phase deviation using the [\[:SOURce\]:PM:DEVIation](#) command.

Return Format The query returns the phase deviation step. For example, 1.000000.

Example :PM:DEV:STEP 1
:PM:DEV:STEP?

Related Command [\[:SOURce\]:PM:DEVIation](#)

[[:SOURce]:PM:EXT:COUP]

Syntax [:SOURce]:PM:EXT:COUP AC|DC
[:SOURce]:PM:EXT:COUP?

Description Set the coupling mode of ØM external modulation.

Query the coupling mode of ØM external modulation.

Parameter

Name	Type	Range	Default
AC DC	Discrete	AC DC	AC

- Explanation**
- AC: set the coupling mode of ØM external modulation to "AC".
 - DC: set the coupling mode of ØM external modulation to "DC".
 - When the modulation source of ØM is set to "Int", this command is invalid.

Return Format The query returns AC or DC.

Example :PM:EXT:COUP AC
:PM:EXT:COUP?

Related Command [\[:SOURce\]:PM:SOURce](#)

[[:SOURce]:PM:EXT:IMP

Syntax [:SOURce]:PM:EXT:IMP 50|600|100k

[:SOURce]:PM:EXT:IMP?

Description Set the impedance of ØM external modulation.

Query the impedance of ØM external modulation.

Parameter

Name	Type	Range	Default
50 600 100k	Discrete	50 600 100k	100k

- Explanation**
- 50: set the impedance of ØM external modulation to "50ohm".
 - 600: set the impedance of ØM external modulation to "600ohm".
 - 100k: set the impedance of ØM external modulation to "100kohm".
 - When the modulation source of ØM is set to "Int", this command is invalid.

Return Format The query returns 50, 600 or 100k.

Example :PM:EXT:IMP 600

:PM:EXT:IMP?

Related Command [\[:SOURce\]:PM:SOURce](#)

[[:SOURce]:PM:FREQuency

Syntax [:SOURce]:PM:FREQuency <value>

[:SOURce]:PM:FREQuency?

Description Set the modulation frequency of ØM.

Query the modulation frequency of ØM.

Parameter

Name	Type	Range	Default
<value>	Real	10Hz to 100kHz (Sine)/10Hz to 20kHz (Square)	10kHz

- Explanation**
- When <value> is set in "Number" form, the default unit is Hz. Besides, <value> can also be set in "Number + Unit" form; for example, 20kHz.
 - After the modulation frequency is set, you can rotate the knob to modify the modulation frequency at the current step. At this point, you can query or set the current step using the [\[:SOURce\]:PM:FREQuency:STEP\[:INCRement\]](#) command.
 - This command is invalid when the ØM modulation source is set to "Ext".

Return Format The query returns the ØM modulation frequency. For example, 20.00000kHz.

Example :PM:FREQ 20kHz

:PM:FREQ?

Related Commands [\[:SOURce\]:PM:FREQuency:STEP\[:INCRement\]](#)
[\[:SOURce\]:PM:SOURce](#)

[[:SOURce]:PM:FREQuency:STEP[:INCRement]]

Syntax [:SOURce]:PM:FREQuency:STEP[:INCRement] <value>

[:SOURce]:PM:FREQuency:STEP[:INCRement]?

Description Set the modulation frequency step of ØM.

Query the modulation frequency step of ØM.

Parameter

Name	Type	Range	Default
<value>	Real	1Hz to 50kHz	1kHz

Explanation

- When <value> is set in "Number" form, the default unit is Hz. Besides, <value> can also be set in "Number + Unit" form; for example, 5kHz.
- After the modulation frequency step is set, you can rotate the knob to modify the modulation frequency at the current step. At this point, you can query or set the modulation frequency using the [\[:SOURce\]:PM:FREQuency](#) command.

Return Format The query returns the modulation frequency step of ØM. For example, 5.00000kHz.

Example :PM:FREQ:STEP 5kHz

:PM:FREQ:STEP?

Related Command [\[:SOURce\]:PM:FREQuency](#)

[[:SOURce]:PM:SOURce]

Syntax [:SOURce]:PM:SOURce EXTERNAL|INTERNAL

[:SOURce]:PM:SOURce?

Description Set the ØM modulation source.

Query the ØM modulation source.

Parameter

Name	Type	Range	Default
EXTERNAL INTERNAL	Discrete	EXTERNAL INTERNAL	INTERNAL

Explanation

- EXTERNAL: select "Ext" modulation source. At this point, the external modulating signal is input from the **[EXT MOD INPUT]** connector.
- INTERNAL: select "Int" modulation source. At this point, the instrument provides the modulating signal and you can set the modulation frequency and modulation waveform of the modulating signal.

Return Format The query returns the ØM modulation source. For example, INT.

Example :PM:SOUR INT

:PM:SOUR?

Related Commands [\[:SOURce\]:PM:FREQuency](#)
[\[:SOURce\]:PM:WAVEform](#)

[[:SOURce]:PM:STATE

Syntax [:SOURce]:PM:STATE ON|OFF|1|0

[:SOURce]:PM:STATE?

Description Turn on or off the ØM switch.

Query the state of the ØM switch.

Parameter

Name	Type	Range	Default
ON OFF 1 0	Bool	ON OFF 1 0	OFF 0

- Explanation**
- ON|1: turn on the ØM switch and enable the ØM function.
 - OFF|0: turn off the ØM switch and disable the ØM function.

Return Format The query returns 1 or 0.

Example :PM:STAT ON /*Turn on the ØM switch*/

:PM:STAT? /*The query returns 1*/

[[:SOURce]:PM:WAVEform

Syntax [:SOURce]:PM:WAVEform SINE|SQUA

[:SOURce]:PM:WAVEform?

Description Set the modulation waveform of ØM.

Query the modulation waveform of ØM.

Parameter

Name	Type	Range	Default
SINE SQUA	Discrete	SINE SQUA	SINE

- Explanation**
- SINE: set the modulation waveform of ØM to "Sine".
 - SQUA: set the modulation waveform of ØM to "Square".
 - This command is invalid when the ØM modulation source is set to "Ext".

Return Format The query returns SINE or SQUA.

Example :PM:WAVE SQUA

:PM:WAVE?

Related Command [\[:SOURce\]:PM:SOURce](#)

[[:SOURce]:PULM Command Subsystem

Command List^[1]:

- ◆ [\[:SOURce\]:PULM:MODE](#)
- ◆ [\[:SOURce\]:PULM:OUT:STATE](#)
- ◆ [\[:SOURce\]:PULM:PERiod](#)
- ◆ [\[:SOURce\]:PULM:PERiod:STEP](#)
- ◆ [\[:SOURce\]:PULM:POLarity](#)
- ◆ [\[:SOURce\]:PULM:SOURce](#)
- ◆ [\[:SOURce\]:PULM:STATE](#)
- ◆ [\[:SOURce\]:PULM:TRAIIn:LIST:COUNT](#)
- ◆ [\[:SOURce\]:PULM:TRAIIn:LIST:GET](#)
- ◆ [\[:SOURce\]:PULM:TRIGger:DELay](#)
- ◆ [\[:SOURce\]:PULM:TRIGger:DELay:STEP](#)
- ◆ [\[:SOURce\]:PULM:TRIGger:EXternal:GATE:POLarity](#)
- ◆ [\[:SOURce\]:PULM:TRIGger:EXternal:SLOPe](#)
- ◆ [\[:SOURce\]:PULM:TRIGger:MODE](#)
- ◆ [\[:SOURce\]:PULM:WIDTH](#)
- ◆ [\[:SOURce\]:PULM:WIDTH:STEP](#)

[[:SOURce]:PULM:MODE

Syntax [:SOURce]:PULM:MODE SINGLE|TRAIIn
[:SOURce]:PULM:MODE?

Description Set the pulse modulation mode.
Query the pulse modulation mode.

Parameter	Name	Type	Range	Default
	SINGLE TRAIIn	Discrete	SINGLE TRAIIn	SINGLE

Explanation

- SINGLE: set the pulse type to "single" and enable the single pulse modulation mode.
- TRAIIn: set the pulse type to "Train" and enable the train pulse modulation mode.
- When "Ext" modulation source is selected, this command is invalid.

Return Format The query returns SINGLE or TRAIN.

Example :PULM:MODE SING
:PULM:MODE?

Related Command [\[:SOURce\]:PULM:SOURce](#)

Note^[1]: To use the related commands of "Train", you need to install the DSG3000B-PUG option. Otherwise, the command settings are invalid. For the installation methods of the option, refer to *DSG3000B User Guide*.

[[:SOURce]:PULM:OUT:STATe

Syntax [:SOURce]:PULM:OUT:STATe ON|OFF|0|1

[:SOURce]:PULM:OUT:STATe?

Description Turn on or off the pulse output switch.

Query the state of the pulse output switch.

Parameter

Name	Type	Range	Default
ON OFF 0 1	Bool	ON OFF 0 1	OFF 0

- Explanation**
- ON|1: turn on the pulse output switch. At this point, the RF signal generator can output the pulse signal generated by the internal pulse generator from the **[PULSE IN/OUT]** connector on the rear panel. Note that this output signal is related to the pulse "Mode" setting.
 - OFF|0: turn off the pulse output switch.
 - When "Ext" modulation source is selected, this command is invalid.

Return Format The query returns 1 or 0.

Example :PULM:OUT:STAT ON /*Turn on the pulse output switch*/

:PULM:OUT:STAT? /*The query returns 1*/

Related Commands [\[:SOURce\]:PULM:MODE](#)
[\[:SOURce\]:PULM:SOURce](#)

[[:SOURce]:PULM:PERiod

Syntax [:SOURce]:PULM:PERiod <value>

[:SOURce]:PULM:PERiod?

Description Set the period of pulse modulation.

Query the period of pulse modulation.

Parameter

Name	Type	Range	Default
<value>	Real	40ns to 170s	1ms

- Explanation**
- When <value> is set in "Number" form, the default unit is s. Besides, <value> can also be set in "Number + Unit" form; for example, 1000ms.
 - After the pulse period is set, you can rotate the knob to modify the period at the current step. At this point, you can query and set the current step using the [\[:SOURce\]:PULM:PERiod:STEP](#) command.
 - When the modulation source is set to "Ext" or the pulse mode is set to "Train", this command is invalid.

Return Format The query returns the period of pulse modulation. For example, 1.000000000s.

Example :PULM:PER 1000ms

:PULM:PER?

Related Commands [\[:SOURce\]:PULM:PERiod:STEP](#)
[\[:SOURce\]:PULM:SOURce](#)
[\[:SOURce\]:PULM:MODE](#)

[[:SOURce]:PULM:PERiod:STEP

Syntax [[:SOURce]:PULM:PERiod:STEP <value>

[[:SOURce]:PULM:PERiod:STEP?

Description Set the step of the pulse modulation period.

Query the step of the pulse modulation period.

Parameter

Name	Type	Range	Default
<value>	Real	10ns to 10s	100us

Explanation

- When <value> is set in "Number" form, the default unit is s. Besides, <value> can also be set in "Number + Unit" form; for example, 5000ms.
- After the pulse period step is set, you can rotate the knob to modify the period at the current step. At this point, you can query and set the pulse period using the [\[:SOURce\]:PULM:PERiod](#) command.

Return Format The query returns the step of the pulse modulation period. For example, 5.000000000s.

Example :PULM:PER:STEP 5000ms

:PULM:PER:STEP?

Related Command [\[:SOURce\]:PULM:PERiod](#)

[[:SOURce]:PULM:POLarity

Syntax [[:SOURce]:PULM:POLarity NORMAL|INVerse

[[:SOURce]:PULM:POLarity?

Description Set the polarity of pulse modulation.

Query the polarity of pulse modulation.

Parameter

Name	Type	Range	Default
NORMAL INVerse	Discrete	NORMAL INVerse	NORMAL

Explanation

- NORMAL: set the polarity of the current pulse modulating signal to "Normal".
- INVerse: set the polarity of the current pulse modulating signal to "Inverse".

Return Format The query returns NORMAL or INVERSE.

Example :PULM:POL INV

:PULM:POL?

[[:SOURce]:PULM:SOURce

Syntax [[:SOURce]:PULM:SOURce INTernal|EXTernal

[[:SOURce]:PULM:SOURce?

Description Set the pulse modulation source.

Query the pulse modulation source.

Parameter

Name	Type	Range	Default
INTernal EXTernal	Discrete	INTernal EXTernal	INTernal

- Explanation**
- INTERNAL: select "Int" modulation source. At this point, the internal pulse generator of the instrument provides the modulating signal. When the "Pulse Out" is turned on, the RF signal generator can output the pulse signal generated by the internal pulse generator from the **[PULSE IN/OUT]** connector on the rear panel.
 - EXTERNAL: select "Ext" modulation source. At this point, the RF signal generator receives the external pulse modulating signal input from the **[PULSE IN/OUT]** connector on the rear panel.

Return Format The query returns the pulse modulation source (INT or EXT).

Example :PULM:SOUR EXT
:PULM:SOUR?

Related Command [\[:SOURce\]:PULM:OUT:STATE](#)

[:SOURce]:PULM:STATE

Syntax [:SOURce]:PULM:STATE ON|OFF|1|0
[:SOURce]:PULM:STATE?

Description Set the state of pulse modulation.
Query the state of pulse modulation.

Parameter	Name	Type	Range	Default
	ON OFF 1 0	Bool	ON OFF 1 0	OFF 0

- Explanation**
- ON|1: turn on the pulse modulation switch to enable the pulse modulation function.
 - OFF|0: turn off the pulse modulation switch to disable the pulse modulation function.

Return Format The query returns 1 or 0.

Example :PULM:STAT ON /*Turn on the pulse modulation switch*/
:PULM:STAT? /*Query the state of pulse modulation and the query returns 1*/

[:SOURce]:PULM:TRAIN:LIST:COUNT

Syntax [:SOURce]:PULM:TRAIN:LIST:COUNT?

Description Acquire the total number of rows in the current train list.

Return Format The query returns the total number of rows in the current train list in integer. For example, 2.

[:SOURce]:PULM:TRAIN:LIST:GET

Syntax [:SOURce]:PULM:TRAIN:LIST:GET? <Start>,<Count>

Description Acquire the train list data within the specified range.

Parameter	Name	Type	Range	Default
	<Start>	Integer	1 to the total number of rows in the current train list	--
	<Count>	Integer	1 to the total number of rows in the current train list	--

- Explanation**
- <Start>: the number of the start row of the train list data to be acquired.
 - <Count>: the total number of rows of the train list data to be acquired.

Return Format The query returns the train list data newly acquired. For example,
 SN.2:2.00 ms , 4.00 ms, 2, 12.00 ms
 SN.3:15.55 ms , 100.50 us, 2, 31.30 ms

Example :PULM:TRA:LIST:GET? 2,2 /*Acquire 2 rows of train data starting from the second row of the train list*/

Related Command [\[:SOURce\]:PULM:TRAI:n:LIST:COUNT](#)

[:SOURce]:PULM:TRIGger:DELay

Syntax [:SOURce]:PULM:TRIGger:DELay <value>
 [:SOURce]:PULM:TRIGger:DELay?

Description Set the pulse trigger delay.

Query the pulse trigger delay.

Parameter	Name	Type	Range	Default
	<value>	Real	10ns to 170s	100us

- Explanation**
- When the modulation source is set to "Int" and the trigger mode is set to "Ext", you can use this command to set the delay from when the pulse modulating signal receives the external trigger signal to the start of the #1 pulse of the pulse modulating signal.
 - When <value> is set in "Number" form, the default unit is s. Besides, <value> can also be set in "Number + Unit" form; for example, 30ns.
 - After the trigger delay is set, you can rotate the knob to modify the trigger delay at the current step. At this point, you can query and set the current step using the [\[:SOURce\]:PULM:TRIGger:DELay:STEP](#) command.

Return Format The query returns the trigger delay. For example, 3.000000000s.

Example :PULM:TRIG:DEL 3 /*Set the trigger delay to 3s*/
 :PULM:TRIG:DEL?

Related Commands [\[:SOURce\]:PULM:SOURce](#)
[\[:SOURce\]:PULM:TRIGger:DELay:STEP](#)
[\[:SOURce\]:PULM:TRIGger:MODE](#)

[[:SOURce]:PULM:TRIGger:DELay:STEP

Syntax [[:SOURce]:PULM:TRIGger:DELay:STEP <value>

[[:SOURce]:PULM:TRIGger:DELay:STEP?

Description Set the step of pulse trigger delay.

Query the step of pulse trigger delay.

Parameter

Name	Type	Range	Default
<value>	Real	10ns to 170s	100us

- Explanation**
- When <value> is set in "Number" form, the default unit is s. Besides, <value> can also be set in "Number + Unit" form; for example, 50ms.
 - After the trigger delay step is set, you can rotate the knob to modify the trigger delay at the current step. At this point, you can query and set the trigger delay using the [\[:SOURce\]:PULM:TRIGger:DELay](#) command.

Return Format The query returns the trigger delay step. For example, 5.000000000s.

Example :PULM:TRIG:DEL:STEP 5 /*Set the trigger delay step to 5s*/

:PULM:TRIG:DEL:STEP?

Related Command [\[:SOURce\]:PULM:TRIGger:DELay](#)

[[:SOURce]:PULM:TRIGger:EXTernal:GATE:POLarity

Syntax [[:SOURce]:PULM:TRIGger:EXTernal:GATE:POLarity NORMal|INVerse

[[:SOURce]:PULM:TRIGger:EXTernal:GATE:POLarity?

Description Set the polarity of the external gated signal.

Query the polarity of the external gated signal.

Parameter

Name	Type	Range	Default
NORMal INVerse	Discrete	NORMal INVerse	NORMal

- Explanation**
- When the trigger mode of pulse modulation is set to "Ext Gate", the RF signal generator receives the external gated signal input from the **[TRIGGER IN]** connector on the rear panel. At this point, you can set the polarity of the external gated signal using this command.
 - NORMal: set the polarity of the external gated signal to "Normal".
 - INVerse: set the polarity of the external gated signal to "Inverse".
 - When the modulation source is set to "Ext", this command is invalid.

Return Format The query returns NORMAL or INVERSE.

Example :PULM:TRIG:EXT:GATE:POL INV

:PULM:TRIG:EXT:GATE:POL?

Related Commands [\[:SOURce\]:PULM:TRIGger:MODE](#)
[\[:SOURce\]:PULM:SOURce](#)

[[:SOURce]:PULM:TRIGger:EXTernal:SLOPe

Syntax [:SOURce]:PULM:TRIGger:EXTernal:SLOPe POSitive|NEGative
[:SOURce]:PULM:TRIGger:EXTernal:SLOPe?

Description Set the polarity of the effective edge of the external trigger pulse.

Query the polarity of the effective edge of the external trigger pulse.

Parameter

Name	Type	Range	Default
POSitive NEGative	Discrete	POSitive NEGative	POSitive

Explanation

- When the trigger mode of pulse modulation is set to "Ext Trig", the RF signal generator receives the external trigger signal input from the **[TRIGGER IN]** connector on the rear panel. At this point, you can use this command to set the trigger edge of the external trigger signal.
- POSitive: set the polarity of the effective edge of the external trigger pulse to "Pos".
- NEGative: set the polarity of the effective edge of the external trigger pulse to "Neg".
- When the modulation source is set to "Ext", this command is invalid.

Return Format The query returns POSITIVE or NEGATIVE.

Example :PULM:TRIG:EXT:SLOP NEG

:PULM:TRIG:EXT:SLOP?

Related Commands

[\[:SOURce\]:PULM:TRIGger:MODE](#)

[\[:SOURce\]:PULM:SOURce](#)

[[:SOURce]:PULM:TRIGger:MODE

Syntax [:SOURce]:PULM:TRIGger:MODE AUTO|EXTernal|EGATe|KEY|BUS
[:SOURce]:PULM:TRIGger:MODE?

Description Set the trigger mode of pulse modulation.

Query the trigger mode of pulse modulation.

Parameter

Name	Type	Range	Default
AUTO EXTernal EGATe KEY BUS	Discrete	AUTO EXTernal EGATe KEY BUS	AUTO

Explanation

- AUTO: select "Auto" trigger mode. At this point, the RF signal generator meets the trigger condition at any time and will start the pulse modulation once the pulse modulation function is turned on.
- EXTernal: select "Ext" trigger mode. At this point, the RF signal generator receives the external trigger signal input from the **[TRIGGER IN]** connector on the rear panel. The instrument starts a pulse modulation each time a TTL pulse with the specified polarity is received. To specify the polarity of the TTL pulse, use the [\[:SOURce\]:PULM:TRIGger:EXTernal:SLOPe](#) command to select "Pos" or "Neg".
- EGATe: select "Ext Gate" trigger mode. At this point, the RF signal generator receives the external gated signal input from the **[TRIGGER IN]** connector on the rear panel. The instrument starts a pulse modulation within the valid level range each time a gated signal with the specified polarity is received. To specify

the polarity of the external gated signal, use the [\[:SOURce\]:PULM:TRIGger:EXternal:GATE:POLarity](#) command to select "Normal" or "Inverse".

- KEY: select "Key" trigger mode. At this point, the instrument starts a pulse modulation each time **Trigger** on the front panel is pressed.
- BUS: select "Bus" trigger mode. At this point, the instrument starts a pulse modulation each time the [*TRG](#) or [:TRIGger:PULSe\[:IMMEDIATE\]](#) command is sent.
- When the modulation source is set to "Ext", this command is invalid.

Return Format The query returns the trigger mode of pulse modulation. For example, EGAT.

Example :PULM:TRIG:MODE EGAT
:PULM:TRIG:MODE?

Related Commands [\[:SOURce\]:PULM:TRIGger:EXternal:GATE:POLarity](#)
[\[:SOURce\]:PULM:TRIGger:EXternal:SLOPe](#)
[\[:SOURce\]:PULM:SOURce](#)
[*TRG](#)
[:TRIGger:PULSe\[:IMMEDIATE\]](#)

[:SOURce]:PULM:WIDTh

Syntax [:SOURce]:PULM:WIDTh <value>
[:SOURce]:PULM:WIDTh?

Description Set the width of the pulse modulating signal.
Query the width of the pulse modulating signal.

Parameter	Name	Type	Range	Default
	<value>	Real	10ns to (170s - 10ns)	500us

- Explanation**
- When <value> is set in "Number" form, the default unit is s. Besides, <value> can also be set in "Number + Unit" form; for example, 2000ms.
 - When the modulation source is set to "Int" and the pulse mode is set to "Single", you can use this command to set the width of the single pulse; otherwise, this command is invalid.
 - After the pulse width is set, you can rotate the knob to modify the pulse width at the current step. At this point, you can query and set the current step using the [\[:SOURce\]:PULM:WIDTh:STEP](#) command.
 - The single pulse width is limited by the minimum pulse width and pulse period and they fulfill the following relations.
Pulse Width ≥ Minimum Pulse Width
Pulse Width ≤ Pulse Period - 10 ns

Return Format The query returns the width of the pulse modulating signal. For example, 2.000000000s.

Example :PULM:WIDT 2
:PULM:WIDT?

Related Commands [\[:SOURce\]:PULM:MODE](#)
[\[:SOURce\]:PULM:PERiod](#)
[\[:SOURce\]:PULM:SOURce](#)
[\[:SOURce\]:PULM:WIDTH:STEP](#)

[:SOURce]:PULM:WIDTH:STEP

Syntax `[:SOURce]:PULM:WIDTH:STEP <value>`
`[:SOURce]:PULM:WIDTH:STEP?`

Description Set the step of the width of the pulse modulating signal.

Query the step of the width of the pulse modulating signal.

Parameter	Name	Type	Range	Default
	<value>	Real	10ns to 10s	100us

Explanation

- When <value> is set in "Number" form, the default unit is s. Besides, <value> can also be set in "Number + Unit" form; for example, 3000ms.
- After the pulse width step is set, you can rotate the knob to modify the pulse width at the current step. At this point, you can query or set the pulse width using the [\[:SOURce\]:PULM:WIDTH](#) command.

Return Format The query returns the step of the width of the pulse modulating signal. For example, 3.000000000s.

Example `:PULM:WIDT:STEP 3`
`:PULM:WIDT:STEP?`

Related Command [\[:SOURce\]:PULM:WIDTH](#)

[[:SOURce]:SWEep Command Subsystem

Command List:

- ◆ [\[:SOURce\]:SWEep:DIRectioN](#)
- ◆ [\[:SOURce\]:SWEep:EXECute](#)
- ◆ [\[:SOURce\]:SWEep:LIST:CPOint](#)
- ◆ [\[:SOURce\]:SWEep:LIST:INITialize:FSep](#)
- ◆ [\[:SOURce\]:SWEep:LIST:INITialize:PRESet](#)
- ◆ [\[:SOURce\]:SWEep:LIST:LIST](#)
- ◆ [\[:SOURce\]:SWEep:MODE](#)
- ◆ [\[:SOURce\]:SWEep:POINT:TRIGger:TYPE](#)
- ◆ [\[:SOURce\]:SWEep:RESet\[:ALL\]](#)
- ◆ [\[:SOURce\]:SWEep:STATe](#)
- ◆ [\[:SOURce\]:SWEep:STEP:DWELl](#)
- ◆ [\[:SOURce\]:SWEep:STEP:DWELl:STEP](#)
- ◆ [\[:SOURce\]:SWEep:STEP:POINTs](#)
- ◆ [\[:SOURce\]:SWEep:STEP:POINTs:STEP](#)
- ◆ [\[:SOURce\]:SWEep:STEP:SHAPE](#)
- ◆ [\[:SOURce\]:SWEep:STEP:SPACing](#)
- ◆ [\[:SOURce\]:SWEep:STEP:START:FREQuency](#)
- ◆ [\[:SOURce\]:SWEep:STEP:START:FREQuency:STEP](#)
- ◆ [\[:SOURce\]:SWEep:STEP:START:LEVel](#)
- ◆ [\[:SOURce\]:SWEep:STEP:START:LEVel:STEP](#)
- ◆ [\[:SOURce\]:SWEep:STEP:STOP:FREQuency](#)
- ◆ [\[:SOURce\]:SWEep:STEP:STOP:FREQuency:STEP](#)
- ◆ [\[:SOURce\]:SWEep:STEP:STOP:LEVel](#)
- ◆ [\[:SOURce\]:SWEep:STEP:STOP:LEVel:STEP](#)
- ◆ [\[:SOURce\]:SWEep:SWEep:TRIGger:TYPE](#)
- ◆ [\[:SOURce\]:SWEep:TYPE](#)

[[:SOURce]:SWEep:DIRection

Syntax [:SOURce]:SWEep:DIRection FWD|REV

[:SOURce]:SWEep:DIRection?

Description Set the sweep direction.

Query the sweep direction.

Parameter

Name	Type	Range	Default
FWD REV	Discrete	FWD REV	FWD

- Explanation**
- FWD: select "Fwd" sweep direction. At this point, the RF signal generator sweeps from the start frequency or start level to the stop frequency or stop level.
 - REV: select "Down" sweep direction. At this point, the RF signal generator sweeps from the stop frequency or stop level to the start frequency or stop level.

Return Format The query returns FWD or REV.

Example :SWE:DIR FWD /*Set the sweep direction to "Fwd"*/
 :SWE:DIR? /*The query returns FWD*/

[[:SOURce]:SWEep:EXECute

Syntax [:SOURce]:SWEep:EXECute

Description Execute a sweep.

- Explanation**
- If the current sweep mode is "Cont", sending this command will change the sweep mode to "Single". The instrument starts a sweep if the trigger condition is currently met.
 - If the current sweep mode is "Single", the instrument starts a sweep if the trigger condition is met after sending this command.

Related Command [\[:SOURce\]:SWEep:MODE](#)

[[:SOURce]:SWEep:LIST:CPOint

Syntax [:SOURce]:SWEep:LIST:CPOint?

Description Query the total number of points in the current sweep list.

Return Format The query returns the total number of sweep points in the sweep list. For example, 5.

[[:SOURce]:SWEep:LIST:INITialize:FSTep

Syntax [[:SOURce]:SWEep:LIST:INITialize:FSTep

Description Recalculate the data points set in the current step sweep to generate a new sweep list.

- Explanation**
- In the new sweep list, "SN" depends on the "Points" of step sweep.
 - "Freq" depends on the "Start Freq" and "Stop Freq" of step sweep.
 - "Level" depends on the "start Lev" and "Stop Lev" of step sweep.
 - "Time" depends on the "Dwell Time" of step sweep.

Related Commands

[\[:SOURce\]:SWEep:STEP:DWELl](#)
[\[:SOURce\]:SWEep:STEP:POINTs](#)
[\[:SOURce\]:SWEep:STEP:START:FREQuency](#)
[\[:SOURce\]:SWEep:STEP:START:LEVel](#)
[\[:SOURce\]:SWEep:STEP:STOP:FREQuency](#)
[\[:SOURce\]:SWEep:STEP:STOP:LEVel](#)

[[:SOURce]:SWEep:LIST:INITialize:PRESet

Syntax [[:SOURce]:SWEep:LIST:INITialize:PRESet

Description Reset the sweep list to the factory setting.

Explanation After resetting the sweep list to the default using this command, the sweep list only contains one frequency point (1.5GHz) and level point (-140dBm).

[[:SOURce]:SWEep:LIST:LIST

Syntax [[:SOURce]:SWEep:LIST:LIST? <Start>,<Count>

Description Acquire the sweep data within the specified range of the sweep list.

Parameter	Name	Type	Range	Default
	<Start>	Integer	1 to the total number of rows in the current list	--
	<Count>	Integer	1 to the total number of rows in the current list	--

- Explanation**
- <Start>: denote the number of the start row of the sweep data to be acquired.
 - <Count>: denote the total number of rows of the sweep data to be acquired.

Return Format The query returns the sweep data newly acquired. For example,

SN.2:2994152687 , -50.000000, 0.500000

SN.3:2888000000 , -60.849998, 0.500000

SN.4:2550000000 , -75.750000, 0.500000

Example :SWE:LIST:LIST? 2,3 /*Acquire 3 rows of sweep data starting from the second row in the sweep list*/

[[:SOURce]:SWEep:MODE

Syntax [:SOURce]:SWEep:MODE CONTInue|SINGle

[:SOURce]:SWEep:MODE?

Description Set the sweep mode.

Query the sweep mode.

Parameter

Name	Type	Range	Default
CONTInue SINGle	Discrete	CONTInue SINGle	CONTInue

- Explanation**
- CONTInue: select "Cont" sweep mode. The instrument sweeps continuously according to the current setting when the trigger condition is met.
 - SINGle: select "Single" sweep mode. The instrument performs a sweep according to the current setting and then stops when the trigger condition is met.

Return Format The query returns the sweep mode (CONT or SING).

Example :SWE:MODE CONT

:SWE:MODE?

[[:SOURce]:SWEep:POINT:TRIGger:TYPE

Syntax [:SOURce]:SWEep:POINT:TRIGger:TYPE AUTO|KEY|BUS|EXT

[:SOURce]:SWEep:POINT:TRIGger:TYPE?

Description Set the point trigger mode of the sweep.

Query the point trigger mode of the sweep.

Parameter

Name	Type	Range	Default
AUTO KEY BUS EXT	Discrete	AUTO KEY BUS EXT	AUTO

- Explanation**
- AUTO: select "Auto" trigger mode. If the sweep mode is set to "Cont", the instrument will start sweeping each sweep point continuously within a sweep period once a sweep manner is selected. If the sweep mode is set to "Single", you need to send the [\[:SOURce\]:SWEep:EXECute](#) command to meet the single sweep condition; after that, the instrument starts to sweep and then stops after the sweep period expires.
 - KEY: select "Key" trigger mode. If the sweep mode is set to "Cont", the instrument starts to sweep a sweep point each time **Trigger** on the front panel is pressed. If the sweep mode is set to "Single", the instrument sweeps a point each time **Trigger** on the front panel is pressed and stops after a sweep period after the [\[:SOURce\]:SWEep:EXECute](#) command is sent and when the single sweep condition is met.
 - BUS: select "Bus" trigger mode. If the sweep mode is set to "Cont", the instrument starts to sweep a point each time the [*TRG](#) or [:TRIGger\[:SWEep\]\[:IMMediate\]](#) command is sent; if the sweep mode is set to "Single", you need to send the [\[:SOURce\]:SWEep:EXECute](#) command to meet the single sweep condition and after that, the instrument starts to sweep a point and then stops after the sweep period expires each time the [*TRG](#) or [:TRIGger\[:SWEep\]\[:IMMediate\]](#) command is sent.
 - EXT: select "Ext" trigger mode. The RF signal generator receives the trigger signal input from the **[TRIGGER IN]** connector on the rear panel. If the sweep mode is set to "Cont", the instrument starts to sweep a point each time a TTL

pulse signal with the specified polarity is received. If the sweep mode is set to "Single", you need to send the [\[:SOURce\]:SWEep:EXECute](#) command to meet the single sweep condition; after that, the instrument starts to sweep a point and then stops after the sweep period expires each time a TTL pulse signal with the specified polarity is received.

Note: The above descriptions are valid when the trigger mode of the corresponding sweep period is met.

- When executing the sweep operation, the priority of the required conditions is: single sweep → trigger mode → point trigger mode.

Return Format The query returns the point trigger mode. For example, AUTO.

Example :SWE:POIN:TRIG:TYPE AUTO
 :SWE:POIN:TRIG:TYPE?

Related Commands [\[:SOURce\]:SWEep:EXECute](#)
[\[:SOURce\]:SWEep:MODE](#)
[\[:SOURce\]:SWEep:SWEep:TRIGger:TYPE](#)
[*TRG](#)
[:TRIGger\[:SWEep\]\[:IMMEDIATE\]](#)

[:SOURce]:SWEep:RESet[:ALL]

Syntax [:SOURce]:SWEep:RESet[:ALL]

Description Reset all the sweeps to the start point.

- Explanation**
- If the current sweep direction is "Fwd", the instrument will stop the current sweep and sweep from the start frequency or start level after sending this command.
 - If the current sweep direction is "Down", the instrument will stop the current sweep and sweep from the stop frequency or stop level after sending this command.

Related Command [\[:SOURce\]:SWEep:DIRection](#)

[:SOURce]:SWEep:STATe

Syntax [:SOURce]:SWEep:STATe OFF|FREQuency|LEVel[,FREQuency]
 [:SOURce]:SWEep:STATe?

Description Set the sweep manner.

Query the sweep manner.

Parameter	Name	Type	Range	Default
	OFF FREQuency LEVel[,FREQuency]	Discrete	OFF FREQuency LEVel LEVel,FREQuency	OFF

- Explanation**
- OFF: turn off the sweep function.
 - FREQuency: enable the frequency sweep function.
 - LEVel: enable the level sweep function.
 - LEVel,FREQuency: enable the frequency and level sweep functions at the same

time.

Return Format The query returns the sweep manner. For example, `FREQ`.

Example `:SWE:STAT FREQ`
`:SWE:STAT?`

[[:SOURce]:SWEep:STEP:DWELI

Syntax `[[:SOURce]:SWEep:STEP:DWELI <value>`
`[[:SOURce]:SWEep:STEP:DWELI?`

Description Set the dwell time of step sweep.

Query the dwell time of step sweep.

Parameter	Name	Type	Range	Default
	<value>	Real	20ms to 100s	500ms

- Explanation**
- When <value> is set in "Number" form, the default unit is s. Besides, <value> can also be set in "Number + Unit" form; for example, 3000ms.
 - After the dwell time is set, you can rotate the knob to modify the dwell time at the current step. At this point, you can query and set the current step using the [\[:SOURce\]:SWEep:STEP:DWELI:STEP](#) command.

Return Format The query returns the dwell time of step sweep. For example, 3.000000000s.

Example `:SWE:STEP:DWEL 3`
`:SWE:STEP:DWEL?`

Related Command [\[:SOURce\]:SWEep:STEP:DWELI:STEP](#)

[[:SOURce]:SWEep:STEP:DWELI:STEP

Syntax `[[:SOURce]:SWEep:STEP:DWELI:STEP <value>`
`[[:SOURce]:SWEep:STEP:DWELI:STEP?`

Description Set the dwell time step.

Query the dwell time step.

Parameter	Name	Type	Range	Default
	<value>	Real	10ms to 10s	10ms

- Explanation**
- When <value> is set in "Number" form, the default unit is s. Besides, <value> can also be set in "Number + Unit" form; for example, 3000ms.
 - After the dwell time step is set, you can rotate the knob to modify the dwell time at the current step. At this point, you can query or set the dwell time using the [\[:SOURce\]:SWEep:STEP:DWELI](#) command.

Return Format The query returns the dwell time step. For example, 3.000000000s.

Example `:SWE:STEP:DWEL:STEP 3`
`:SWE:STEP:DWEL:STEP?`

Related Command [\[:SOURce\]:SWEep:STEP:DWELI](#)

[[:SOURce]:SWEep:STEP:POINTs]

Syntax [[:SOURce]:SWEep:STEP:POINTs <value>

[[:SOURce]:SWEep:STEP:POINTs?

Description Set the number of points of step sweep.

Query the number of points of step sweep.

Parameter

Name	Type	Range	Default
<value>	Integer	2 to 65535	11

- Explanation**
- The number of sweep points decides the time interval between two neighboring sweep points.
 - After the number of sweep points is set, you can rotate the knob to modify the number of sweep points at the current step. At this point, you can query or set the current step using the [\[\[:SOURce\]:SWEep:STEP:POINTs:STEP\]](#) command.

Return Format The query returns the number of sweep points. For example, 5.

Example :SWE:STEP:POIN 5

:SWE:STEP:POIN?

Related Command [\[\[:SOURce\]:SWEep:STEP:POINTs:STEP\]](#)

[[:SOURce]:SWEep:STEP:POINTs:STEP]

Syntax [[:SOURce]:SWEep:STEP:POINTs:STEP <value>

[[:SOURce]:SWEep:STEP:POINTs:STEP?

Description Set the step of the number of sweep points.

Query the step of the number of sweep points.

Parameter

Name	Type	Range	Default
<value>	Integer	1 to 10000	1

- Explanation**
- After the step of the number of sweep points is set, you can rotate the knob to modify the number of sweep points at the current step. At this point, you can query or set the number of sweep points using the [\[\[:SOURce\]:SWEep:STEP:POINTs\]](#) command.

Return Format The query returns the step of the number of sweep points. For example, 2.

Example :SWE:STEP:POIN:STEP 2

:SWE:STEP:POIN:STEP?

Related Command [\[\[:SOURce\]:SWEep:STEP:POINTs\]](#)

[[:SOURce]:SWEep:STEP:SHAPE]

Syntax [[:SOURce]:SWEep:STEP:SHAPE TRIangle|RAMP

[[:SOURce]:SWEep:STEP:SHAPE?

Description Set the step sweep shape.

Query the step sweep shape.

Parameter	Name	Type	Range	Default
	TRIAngle RAMP	Discrete	TRIAngle RAMP	RAMP

- Explanation**
- The sweep shape decides the cycle mode of multiple sweeps.
 - TRIangle: select "Triangle" waveform. The sweep period always starts from the start frequency or start level to the stop frequency or stop level and then returns back to the start frequency or start level (when the sweep direction is "Fwd").
 - RAMP: select "Ramp" waveform. The sweep period always starts from the start frequency or start level to the stop frequency or stop level (when the sweep direction is "Fwd").

Return Format The query returns TRI or RAMP.

Example :SWE:STEP:SHAP TRI
:SWE:STEP:SHAP?

Related Command [\[:SOURce\]:SWEep:DIRection](#)

[:SOURce]:SWEep:STEP:SPACing

Syntax [:SOURce]:SWEep:STEP:SPACing LINear|LOGarithmic
[:SOURce]:SWEep:STEP:SPACing?

Description Set the step sweep spacing.

Query the step sweep spacing.

Parameter	Name	Type	Range	Default
	LINear LOGarithmic	Discrete	LINear LOGarithmic	LINear

- Explanation**
- The sweep spacing refers to the variation mode from one frequency or level to another frequency or level within a step.
 - LINear: set the sweep spacing to "Lin". Note that level sweep only supports "Lin" sweep spacing.
 - LOGarithmic: set the sweep spacing to "Log".

Return Format The query returns LIN or LOG.

Example :SWE:STEP:SPAC LIN
:SWE:STEP:SPAC?

[:SOURce]:SWEep:STEP:START:FREQuency

Syntax [:SOURce]:SWEep:STEP:START:FREQuency <value>
[:SOURce]:SWEep:STEP:START:FREQuency?

Description Set the start frequency of the sweep.

Query the start frequency of the sweep.

Parameter	Name	Type	Range	Default
	<value>	Real	9kHz to 13.6GHz	1GHz

- Explanation**
- When <value> is set in "Number" form, the default unit is Hz. Besides, <value> can also be set in "Number + Unit" form; for example, 4MHz.
 - After the start frequency is set, you can rotate the knob to modify the start frequency at the current step. At this point, you can query or set the current step using the [\[:SOURce\]:SWEep:STEP:START:FREQuency:STEP](#) command.

Return Format The query returns the start frequency of the sweep. For example, 4.00000000MHz.

Example :SWE:STEP:STAR:FREQ 4MHz
:SWE:STEP:STAR:FREQ?

Related Command [\[:SOURce\]:SWEep:STEP:START:FREQuency:STEP](#)

[:SOURce]:SWEep:STEP:START:FREQuency:STEP

Syntax [:SOURce]:SWEep:STEP:START:FREQuency:STEP <value>
[:SOURce]:SWEep:STEP:START:FREQuency:STEP?

Description Set the start frequency step of the sweep.

Query the start frequency step of the sweep.

Parameter	Name	Type	Range	Default
	<value>	Real	10mHz to 1GHz	1GHz

- Explanation**
- When <value> is set in "Number" form, the default unit is Hz. Besides, <value> can also be set in "Number + Unit" form; for example, 3kHz.
 - After the start frequency step is set, you can rotate the knob to modify the start frequency at the current step. At this point, you can query or set the start frequency using the [\[:SOURce\]:SWEep:STEP:START:FREQuency](#) command.

Return Format The query returns the start frequency step of the sweep. For example, 3.00000kHz.

Example :SWE:STEP:STAR:FREQ:STEP 3kHz
:SWE:STEP:STAR:FREQ:STEP?

Related Command [\[:SOURce\]:SWEep:STEP:START:FREQuency](#)

[:SOURce]:SWEep:STEP:START:LEVel

Syntax [:SOURce]:SWEep:STEP:START:LEVel <value>
[:SOURce]:SWEep:STEP:START:LEVel?

Description Set the start level of the sweep.

Query the start level of the sweep.

Parameter	Name	Type	Range	Default
	<value>	Real	-130dBm to 27dBm	-10dBm

- Explanation**
- When <value> is set in "Number" form (for example, 2), the default unit is dBm. When <value> is set in "Number + Unit" form (for example, 2dBm), the start level displayed in the interface of the RF signal generator is related to the setting of **Level Unit**.
 - When the level unit is "dBm", 2.00dBm is displayed.
 - When the level unit is "dBmV", 48.99dBmV is displayed.
 - When the level unit is "dBuV", 108.99dBuV is displayed.
 - When the level unit is "Volts", 281.50mV is displayed.
 - When the level unit is "Watts", 1.58mW is displayed.
 - The default unit of the return value is dBm.
 - After the start level is set, you can rotate the knob to modify the start level at the current step. At this point, you can query or set the current step using the [\[:SOURce\]:SWEep:STEP:STARt:LEVel:STEP](#) command.

Return Format The query returns the start level of the sweep. For example, 2.00.

Example :SWE:STEP:STAR:LEV 2dBm
 :SWE:STEP:STAR:LEV?

Related Command [\[:SOURce\]:SWEep:STEP:STARt:LEVel:STEP](#)

[:SOURce]:SWEep:STEP:STARt:LEVel:STEP

Syntax [:SOURce]:SWEep:STEP:STARt:LEVel:STEP <value>
 [:SOURce]:SWEep:STEP:STARt:LEVel:STEP?

Description Set the start level step of the sweep.
 Query the start level step of the sweep.

Parameter	Name	Type	Range	Default
	<value>	Real	0.01dB to 100dB	1dB

- Explanation**
- When <value> is set in "Number" form, the default unit is dB. Besides, <value> can also be set in "Number + Unit" form; for example, 20dB.
 - The default unit of the return value is dB.
 - After the start level step is set, you can rotate the knob to modify the start level at the current step. At this point, you can query or set the start level using the [\[:SOURce\]:SWEep:STEP:STARt:LEVel](#) command.

Return Format The query returns the start level step of the sweep. For example, 20.00.

Example :SWE:STEP:STAR:LEV:STEP 20
 :SWE:STEP:STAR:LEV:STEP?

Related Command [\[:SOURce\]:SWEep:STEP:STARt:LEVel](#)

[:SOURce]:SWEep:STEP:STOP:FREQuency

Syntax [:SOURce]:SWEep:STEP:STOP:FREQuency <value>
 [:SOURce]:SWEep:STEP:STOP:FREQuency?

Description Set the stop frequency of the sweep.

Query the stop frequency of the sweep.

Parameter

Name	Type	Range	Default
<value>	Real	9kHz to 13.6GHz	2GHz

Explanation

- When <value> is set in "Number" form, the default unit is Hz. Besides, <value> can also be set in "Number + Unit" form; for example, 4MHz.
- After the stop frequency is set, you can rotate the knob to modify the stop frequency at the current step. At this point, you can query or set the current step using the [\[:SOURce\]:SWEep:STEP:STOP:FREQuency:STEP](#) command.

Return Format

The query returns the stop frequency of the sweep. For example, 4.00000000MHz.

Example

:SWE:STEP:STOP:FREQ 4MHz

:SWE:STEP:STOP:FREQ?

Related Command

[\[:SOURce\]:SWEep:STEP:STOP:FREQuency:STEP](#)

[:SOURce]:SWEep:STEP:STOP:FREQuency:STEP

Syntax

[\[:SOURce\]:SWEep:STEP:STOP:FREQuency:STEP](#) <value>

[\[:SOURce\]:SWEep:STEP:STOP:FREQuency:STEP?](#)

Description

Set the stop frequency step of the sweep.

Query the stop frequency step of the sweep.

Parameter

Name	Type	Range	Default
<value>	Real	10mHz to 1GHz	100MHz

Explanation

- When <value> is set in "Number" form, the default unit is Hz. Besides, <value> can also be set in "Number + Unit" form, for example, 3kHz.
- After the stop frequency step is set, you can rotate the knob to modify the stop frequency at the current step. At this point, you can query or set the stop frequency using the [\[:SOURce\]:SWEep:STEP:STOP:FREQuency](#) command.

Return Format

The query returns the stop frequency step of the sweep. For example, 3.00000kHz.

Example

:SWE:STEP:STOP:FREQ:STEP 3kHz

:SWE:STEP:STOP:FREQ:STEP?

Related Command

[\[:SOURce\]:SWEep:STEP:STOP:FREQuency](#)

[:SOURce]:SWEep:STEP:STOP:LEVel

Syntax

[\[:SOURce\]:SWEep:STEP:STOP:LEVel](#) <value>

[\[:SOURce\]:SWEep:STEP:STOP:LEVel?](#)

Description

Set the stop level of the sweep.

Query the stop level of the sweep.

Parameter

Name	Type	Range	Default
<value>	Real	-130dBm to 27dBm	-20dBm

- Explanation**
- When <value> is set in "Number" form (for example, 2), the default unit is dBm. When <value> is set in "Number + Unit" form (for example, 2dBm), the stop level displayed in the interface of the RF signal generator is related to the setting of **Level Unit**.
 - When the level unit is "dBm", 2.00dBm is displayed.
 - When the level unit is "dBmV", 48.99dBmV is displayed.
 - When the level unit is "dBuV", 108.99dBuV is displayed.
 - When the level unit is "Volts", 281.50mV is displayed.
 - When the level unit is "Watts", 1.58mW is displayed.
 - The default unit of the return value is dBm.
 - After the stop level is set, you can rotate the knob to modify the stop level at the current step. At this point, you can query or set the current step using the [\[:SOURce\]:SWEep:STEP:STOP:LEVel:STEP](#) command.

Return Format The query returns the stop level of the sweep. For example, 2.000000.

Example :SWE:STEP:STOP:LEV 2dBm
 :SWE:STEP:STOP:LEV?

Related Command [\[:SOURce\]:SWEep:STEP:STOP:LEVel:STEP](#)

[:SOURce]:SWEep:STEP:STOP:LEVel:STEP

Syntax [:SOURce]:SWEep:STEP:STOP:LEVel:STEP <value>
 [:SOURce]:SWEep:STEP:STOP:LEVel:STEP?

Description Set the stop level step of the sweep.
 Query the stop level step of the sweep.

Parameter	Name	Type	Range	Default
	<value>	Real	0.01dB to 100dB	1dB

- Explanation**
- When <value> is set in "Number" form, the default unit is dB. Besides, <value> can also be set in "Number + Unit" form; for example, 20dB.
 - The default unit of the return value is dB.
 - After the stop level step is set, you can rotate the knob to modify the stop level at the current step. At this point, you can query or set the stop level using the [\[:SOURce\]:SWEep:STEP:STOP:LEVel](#) command.

Return Format The query returns the stop level step of the sweep. For example, 20.000000.

Example :SWE:STEP:STOP:LEV:STEP 20
 :SWE:STEP:STOP:LEV:STEP?

Related Command [\[:SOURce\]:SWEep:STEP:STOP:LEVel](#)

[[:SOURce]:SWEep:SWEep:TRIGger:TYPE

Syntax [[:SOURce]:SWEep:SWEep:TRIGger:TYPE AUTO|KEY|BUS|EXT

[[:SOURce]:SWEep:SWEep:TRIGger:TYPE?

Description Set the trigger mode of the sweep period.

Query the trigger mode of the sweep period.

Parameter

Name	Type	Range	Default
AUTO KEY BUS EXT	Discrete	AUTO KEY BUS EXT	AUTO

- Explanation**
- AUTO: select "Auto" trigger mode. If the sweep mode is set to "Cont", the instrument will start sweeping once a sweep manner is selected. If the sweep mode is set to "Single", you need to send the [\[:SOURce\]:SWEep:EXECute](#) command to meet the single sweep condition; after that, the instrument will start a sweep and then stops.
 - KEY: select "Key" trigger mode. If the sweep mode is set to "Cont", the instrument starts a sweep each time **Trigger** on the front panel is pressed. If the sweep mode is set to "Single", the instrument starts a sweep and then stops each time **Trigger** on the front panel is pressed after the [\[:SOURce\]:SWEep:EXECute](#) command is sent and when the single sweep condition is met.
 - BUS: select "Bus" trigger mode. If the sweep mode is set to "Cont", the instrument starts a sweep each time the [*TRG](#) or [:TRIGger\[:SWEep\]\[:IMMEDIATE\]](#) command is sent; if the sweep mode is set to "Single", you need to send the [\[:SOURce\]:SWEep:EXECute](#) command to meet the single sweep condition and after that, the instrument starts a sweep and then stops each time the [*TRG](#) or [:TRIGger\[:SWEep\]\[:IMMEDIATE\]](#) command is sent.
 - EXT: select "Ext" trigger mode. The RF signal generator receives the trigger signal input from the **[TRIGGER IN]** connector on the rear panel. If the sweep mode is set to "Cont", the instrument starts a sweep each time a TTL pulse signal with the specified polarity is received. If the sweep mode is set to "Single", you need to send the [\[:SOURce\]:SWEep:EXECute](#) command to meet the single sweep condition; after that, the instrument starts a sweep and then stops each time a TTL pulse signal with the specified polarity is received.
- Note:** The above explanations are only valid when the trigger mode of each sweep point within the sweep period is met.
- When executing the sweep operation, the priority of the required conditions is: single sweep → trigger mode → point trigger mode.

Return Format The query returns the trigger mode of the sweep. For example, AUTO.

Example :SWE:SWE:TRIG:TYPE AUTO

:SWE:SWE:TRIG:TYPE?

Related Commands

[\[:SOURce\]:SWEep:EXECute](#)

[\[:SOURce\]:SWEep:MODE](#)

[\[:SOURce\]:SWEep:POINT:TRIGger:TYPE](#)

[*TRG](#)

[:TRIGger\[:SWEep\]\[:IMMEDIATE\]](#)

[[:SOURce]:SWEep:TYPE

Syntax [:SOURce]:SWEep:TYPE LIST|STEP
[:SOURce]:SWEep:TYPE?

Description Set the sweep type.

Query the sweep type.

Parameter

Name	Type	Range	Default
LIST STEP	Discrete	LIST STEP	STEP

- Explanation**
- LIST: select "List" sweep type. At this point, the RF signal generator sweeps according to the sweep list currently loaded.
 - STEP: select "Step" sweep type. At this point, the RF signal generator performs step sweep according the current setting.

Return Format The query returns the sweep type (LIST or STEP).

Example :SWE:TYPE STEP
:SWE:TYPE?

:STATus Commands

The :STATus commands and IEEE488.2 common commands are mainly used to operate or query the status register. The structure of the status register is as shown in the figure below. It includes the questionable status register, operation status register, standard event status register, status byte register and error queue. The STATus commands are used to set and query the questionable status register and operation status register; the IEEE488.2 common commands are used to perform operations on the standard event status register and status byte register.

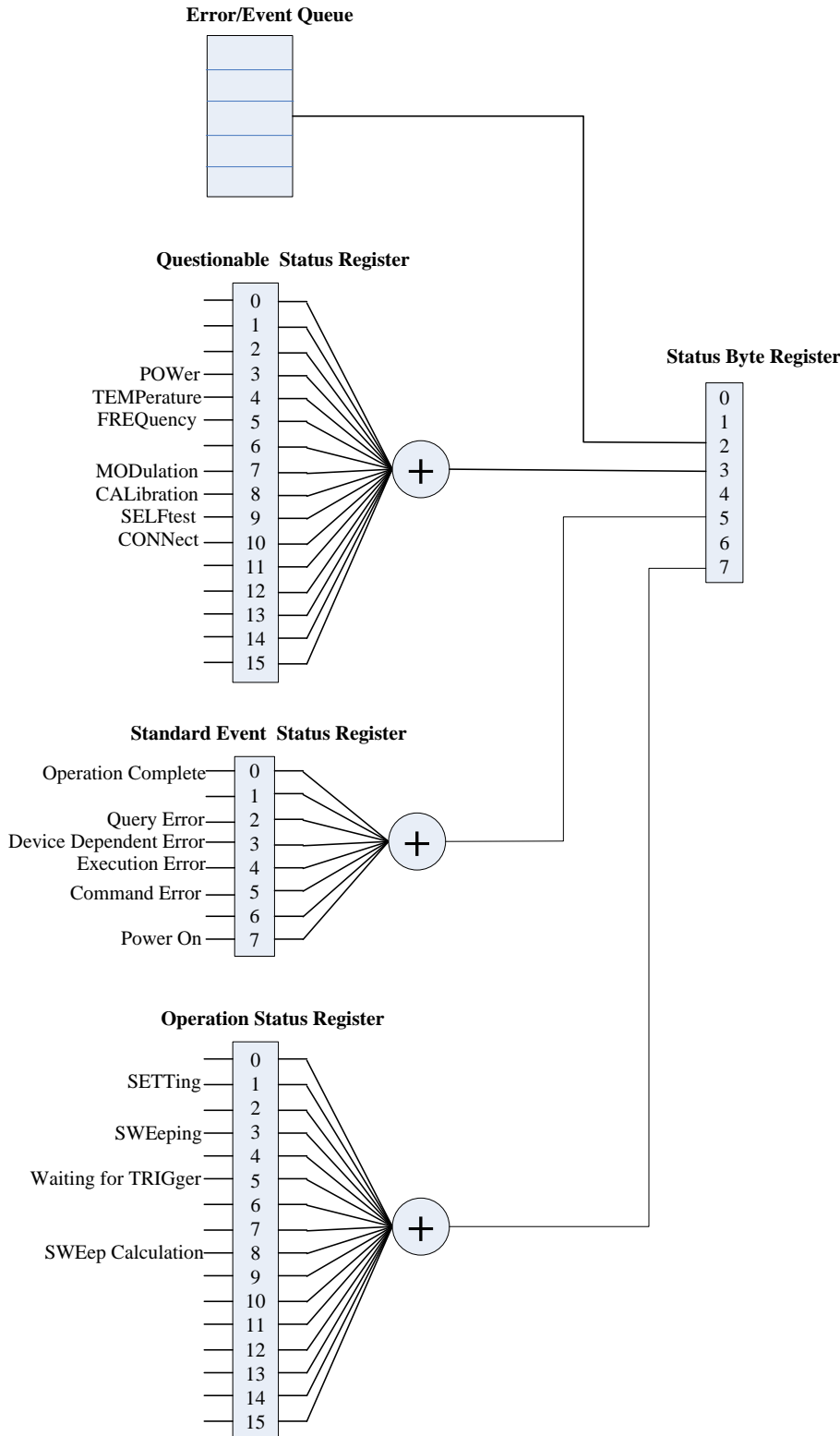

The definitions of the questionable status register are as shown in the table below. Wherein, bit 0 to bit 2, bit 6 and bit 11 to bit 15 are not used and will be always treated as 0.

Bit	Value	Definition
0	0	Not Used
1	0	Not Used
2	0	Not Used
3	8	Power
4	16	Temperature
5	32	Frequency
6	0	Not Used
7	128	Modulation
8	256	Calibration
9	512	Selftest
10	1024	Connect
11	0	Not Used
12	0	Not Used
13	0	Not Used
14	0	Not Used
15	0	Not Used

The definitions of the operation status register are as shown in the table below. Wherein, bit 0, bit 2, bit 4, bit 6, bit 7 and bit 9 to bit 15 are not used and will always be treated as 0.

Bit	Value	Definition
0	0	Not Used
1	2	Setting
2	0	Not Used
3	8	Sweeping
4	0	Not Used
5	32	Waiting for Trigger
6	0	Not Used
7	0	Not Used
8	256	Sweep Calculation
9	0	Not Used
10	0	Not Used
11	0	Not Used
12	0	Not Used
13	0	Not Used
14	0	Not Used
15	0	Not Used

Command List:

- ◆ [:STATus:OPERation:CONDition](#)
- ◆ [:STATus:OPERation:ENABle](#)
- ◆ [:STATus:OPERation\[:EVENT\]](#)
- ◆ [:STATus:QUEStionable:CALibration:CONDition](#)
- ◆ [:STATus:QUEStionable:CALibration:ENABle](#)
- ◆ [:STATus:QUEStionable:CALibration\[:EVENT\]](#)
- ◆ [:STATus:QUEStionable:CONDition](#)
- ◆ [:STATus:QUEStionable:CONNect:CONDition](#)
- ◆ [:STATus:QUEStionable:CONNect:ENABle](#)
- ◆ [:STATus:QUEStionable:CONNect\[:EVENT\]](#)
- ◆ [:STATus:QUEStionable:ENABle](#)
- ◆ [:STATus:QUEStionable\[:EVENT\]](#)
- ◆ [:STATus:QUEStionable:FREQuency:CONDition](#)
- ◆ [:STATus:QUEStionable:FREQuency:ENABle](#)
- ◆ [:STATus:QUEStionable:FREQuency\[:EVENT\]](#)
- ◆ [:STATus:QUEStionable:MODulation:CONDition](#)
- ◆ [:STATus:QUEStionable:MODulation:ENABle](#)
- ◆ [:STATus:QUEStionable:MODulation\[:EVENT\]](#)
- ◆ [:STATus:QUEStionable:POWer:CONDition](#)
- ◆ [:STATus:QUEStionable:POWer:ENABle](#)
- ◆ [:STATus:QUEStionable:POWer\[:EVENT\]](#)
- ◆ [:STATus:QUEStionable:SELFtest:CONDition](#)
- ◆ [:STATus:QUEStionable:SELFtest:ENABle](#)
- ◆ [:STATus:QUEStionable:SELFtest\[:EVENT\]](#)
- ◆ [:STATus:QUEStionable:TEMP:CONDition](#)
- ◆ [:STATus:QUEStionable:TEMP:ENABle](#)
- ◆ [:STATus:QUEStionable:TEMP\[:EVENT\]](#)

:STATus:OPERation:CONDition

Syntax :STATus:OPERation:CONDition?

Description Query the value of the condition register for the operation status register.

Explanation The bit 0, bit 2, bit 4, bit 6, bit 7 and bit 9 to bit 15 of the operation status register are not used and will always be treated as 0; therefore, the range of the return value of the command are the decimal numbers corresponding to the binary numbers ranging from 0000000000000000 (0 in decimal) to 1111111111111111 (32767 in decimal) and of which the bit 0, bit 2, bit 4, bit 6, bit 7 and bit 9 to bit 15 are 0.

Return Format The query returns the value of the condition register in integer. For example, 0.

:STATus:OPERation:ENABLE

Syntax :STATus:OPERation:ENABLE <value>

:STATus:OPERation:ENABLE?

Description Set the value of the enable register for the operation status register.
Query the value of the enable register for the operation status register.

Parameter	Name	Type	Range	Default
	<value>	Integer	Refer to the "Explanation"	0

Explanation The range of <value> are the decimal numbers corresponding to the binary numbers ranging from 0000000000000000 (0 in decimal) to 1111111111111111 (32767 in decimal).

Return Format The query returns the value of the enable register of the operation status register in integer.

Example :STAT:OPER:ENAB 100

:STAT:OPER:ENAB?

:STATus:OPERation[:EVENT]

Syntax :STATus:OPERation[:EVENT]?

Description Query the value of the event register for the operation status register.

Explanation The bit 0, bit 2, bit 4, bit 6, bit 7 and bit 9 to bit 15 of the operation status register are not used and will always be treated as 0; therefore, the range of the return value of the command are the decimal numbers corresponding to the binary numbers ranging from 0000000000000000 (0 in decimal) to 1111111111111111 (32767 in decimal) and of which the bit 0, bit 2, bit 4, bit 6, bit 7 and bit 9 to bit 15 are 0.

Return Format The query returns the value of the event register in integer. For example, 0.

:STATus:QUESTionable:CALibration:CONDition

Syntax :STATus:QUESTionable:CALibration:CONDition?

Description Query the value of the condition register for the questionable calibration status register.

Explanation ➤ The relation between the calibration status register and questionable status register is as shown in the figure below.

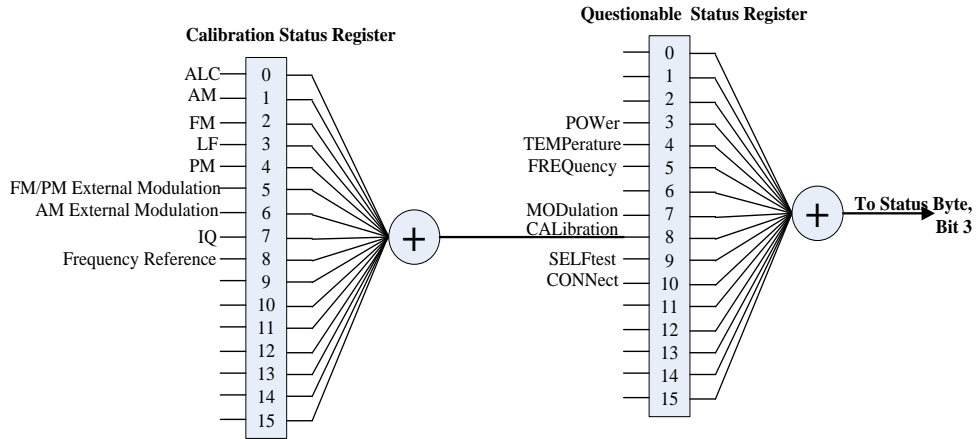

➤ The definitions of the questionable calibration status register are as shown in the table below. Wherein, bit 0 and bit 9 to bit 15 are not used and will be always treated as 0. The range of the return value are the decimal numbers corresponding to the binary numbers ranging from 0000000000000000 (0 in decimal) to 1111111111111111 (32767 in decimal) and of which the bit 0 and bit 9 to bit 15 are 0 (bit 2 and bit 4 cannot be 1 at the same time).

Bit	Value	Definition
0	1	Not Used
1	2	AM
2	4	FM
3	8	LF
4	16	ØM
5	32	FM/ØM External Modulation
6	64	AM External Modulation
7	128	IQ
8	256	Frequency Reference
9	0	Not Used
10	0	Not Used
11	0	Not Used
12	0	Not Used
13	0	Not Used
14	0	Not Used
15	0	Not Used

Return Format The query returns the value of the condition register of the questionable calibration status register in integer. For example, 24.

:STATus:QUESTionable:CALibration:ENABLE

Syntax :STATus:QUESTionable:CALibration:ENABLE <value>
:STATus:QUESTionable:CALibration:ENABLE?

Description Set the value of the enable register for the questionable calibration status register.
Query the value of the enable register for the questionable calibration status register.

Parameter	Name	Type	Range	Default
	<value>	Integer	Refer to the "Explanation"	0

Explanation In the questionable calibration status register, the range of <value> are the decimal numbers corresponding to the binary numbers ranging from 0000000000000000 (0 in decimal) to 1111111111111111 (32767 in decimal).

Return Format The query returns the value of the enable register of the questionable calibration status register in integer.

Example :STAT:QUES:CAL:ENAB 100
:STAT:QUES:CAL:ENAB?

:STATus:QUESTionable:CALibration[:EVENT]

Syntax :STATus:QUESTionable:CALibration[:EVENT]?

Description Query the value of the event register for the questionable calibration status register.

Explanation The bit 0 and bit 9 to bit 15 of the questionable calibration status register are not used and will be always treated as 0. The range of the return value are the decimal numbers corresponding to the binary numbers ranging from 0000000000000000 (0 in decimal) to 1111111111111111 (32767 in decimal) and of which the bit 0 and bit 9 to bit 15 are 0 (bit 2 and bit 4 cannot be 1 at the same time).

Return Format The query returns the value of the event register of the questionable calibration status register in integer. For example, 24.

:STATus:QUESTionable:CONDition

Syntax :STATus:QUESTionable:CONDition?

Description Query the value of the condition register for the questionable status register.

Explanation The bit 0 to bit 2, bit 6 and bit 11 to bit 15 of the questionable status register are not used and are always treated as 0; therefore, the range of the return value are the decimal numbers corresponding to the binary numbers ranging from 0000000000000000 (0 in decimal) to 1111111111111111 (32767 in decimal) and of which the bit 0 to bit 2, bit 6 and bit 11 to bit 15 are 0.

Return Format The query returns the value of the condition register of the questionable status register in integer. For example, 0.

:STATus:QUESTionable:CONNect:CONDition

Syntax :STATus:QUESTionable:CONNect:CONDition?

Description Query the value of the condition register for the questionable connect status register.

Explanation ➤ The relation between the connect status register and questionable status register is as shown in the figure below.

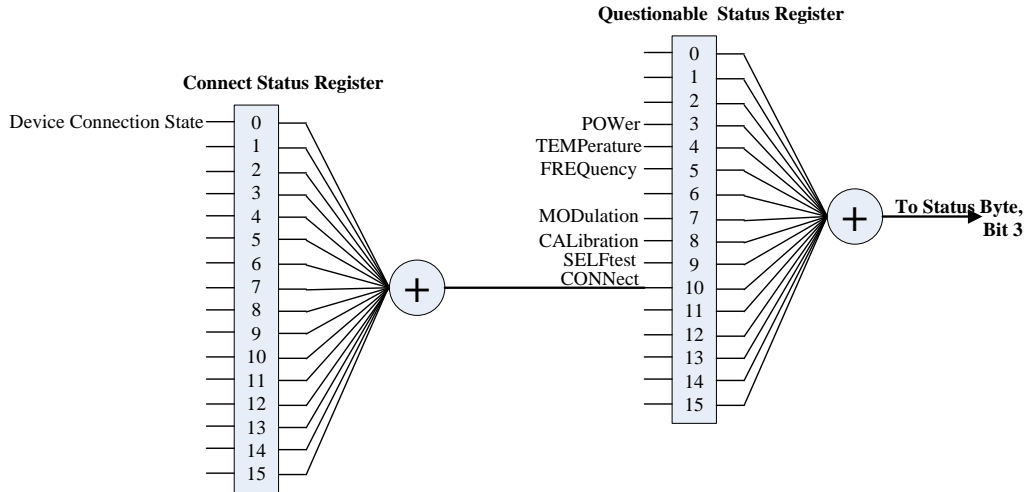

➤ The definitions of the questionable connect status register are as shown in the table below. Wherein, bit 1 to bit 15 are not used and will be always treated as 0. The range of the return value are the decimal numbers corresponding to the binary numbers ranging from 0000000000000000 (0 in decimal) to 0000000000000001 (1 in decimal).

Bit	Value	Definition
0	1	Device Connection State
1	0	Not Used
2	0	Not Used
3	0	Not Used
4	0	Not Used
5	0	Not Used
6	0	Not Used
7	0	Not Used
8	0	Not Used
9	0	Not Used
10	0	Not Used
11	0	Not Used
12	0	Not Used
13	0	Not Used
14	0	Not Used
15	0	Not Used

Return Format The query returns the value of the condition register of the questionable connect status register in integer. For example, 0.

:STATus:QUESTionable:CONNect:ENABLE

Syntax :STATus:QUESTionable:CONNect:ENABLE <value>

:STATus:QUESTionable:CONNect:ENABLE?

Description Set the value of the enable register for the questionable connect status register.

Query the value of the enable register for the questionable connect status register.

Parameter

Name	Type	Range	Default
<value>	Integer	Refer to the "Explanation"	0

Explanation In the questionable connect status register, the range of <value> are the decimal numbers corresponding to the binary numbers ranging from 0000000000000000 (0 in decimal) to 1111111111111111 (32767 in decimal).

Return Format The query returns the value of the enable register of the questionable connect status register in integer.

Example :STAT:QUES:CONN:ENAB 1

:STAT:QUES:CONN:ENAB?

:STATus:QUESTionable:CONNect[:EVENT]

Syntax :STATus:QUESTionable:CONNect[:EVENT]?

Description Query the value of the event register for the questionable connect status register.

Explanation The bit 1 to bit 15 of the questionable connect status register are not used and will be always treated as 0. The range of the return value are the decimal numbers corresponding to the binary numbers ranging from 0000000000000000 (0 in decimal) to 0000000000000001 (1 in decimal).

Return Format The query returns the value of the event register of the questionable connect status register in integer.

:STATus:QUESTionable:ENABLE

Syntax :STATus:QUESTionable:ENABLE <value>

:STATus:QUESTionable:ENABLE?

Description Set the value of the enable register for the questionable status register.

Query the value of the enable register for the questionable status register.

Parameter

Name	Type	Range	Default
<value>	Integer	Refer to the "Explanation"	0

Explanation The range of <value> are the decimal numbers corresponding to the binary numbers ranging from 0000000000000000 (0 in decimal) to 1111111111111111 (32767 in decimal).

Return Format The query returns the value of the enable register of the questionable status register in integer.

Example :STAT:QUES:ENAB 100

:STAT:QUES:ENAB?

:STATus:QUEStionable[:EVENT]

Syntax :STATus:QUEStionable[:EVENT]?

Description Query the value of the event register for the questionable status register.

Explanation The bit 0 to bit 2, bit 6 and bit 11 to bit 15 of the questionable status register are not used and are always treated as 0; therefore, the range of the return value are the decimal numbers corresponding to the binary numbers ranging from 0000000000000000 (0 in decimal) to 1111111111111111 (32767 in decimal) and of which the bit 0 to bit 2, bit 6 and bit 11 to bit 15 are 0.

Return Format The query returns the value of the event register of the questionable status register in integer. For example, 0.

:STATus:QUESTionable:FREQuency:CONDition

Syntax :STATus:QUESTionable:FREQuency:CONDition?

Description Query the value of the condition register for the questionable frequency status register.

Explanation ➤ The relation between the frequency status register and questionable status register is as shown in the figure below.

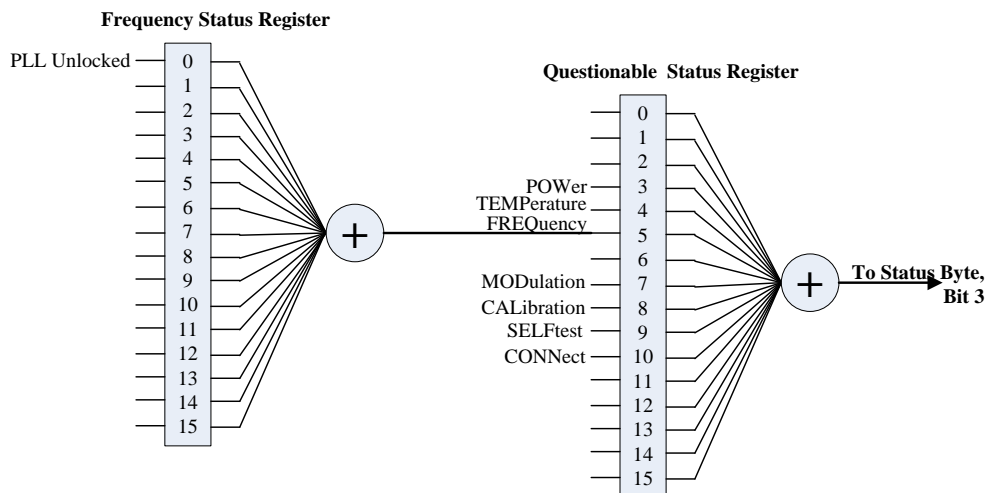

➤ The definitions of the questionable frequency status register are as shown in the table below. Wherein, bit 1 to bit 15 are not used and will be always treated as 0. The range of the return value are the decimal numbers corresponding to the binary numbers ranging from 0000000000000000 (0 in decimal) to 0000000000000001 (1 in decimal).

Bit	Value	Definition
0	1	PLL Unlocked
1	0	Not Used
2	0	Not Used
3	0	Not Used
4	0	Not Used
5	0	Not Used
6	0	Not Used
7	0	Not Used
8	0	Not Used
9	0	Not Used
10	0	Not Used
11	0	Not Used
12	0	Not Used
13	0	Not Used
14	0	Not Used
15	0	Not Used

Return Format The query returns the value of the condition register of the questionable frequency status register in integer.

:STATus:QUESTionable:FREQuency:ENABle

Syntax :STATus:QUESTionable:FREQuency:ENABle <value>
:STATus:QUESTionable:FREQuency:ENABle?

Description Set the value of the enable register for the questionable frequency status register.
Query the value of the enable register for the questionable frequency status register.

Parameter	Name	Type	Range	Default
	<value>	Integer	Refer to the "Explanation"	0

Explanation In the questionable frequency status register, the range of <value> are the decimal numbers corresponding to the binary numbers ranging from 0000000000000000 (0 in decimal) to 1111111111111111 (32767 in decimal).

Return Format The query returns the value of the enable register of the questionable frequency status register in integer.

Example :STAT:QUES:FREQ:ENAB 1
:STAT:QUES:FREQ:ENAB?

:STATus:QUESTionable:FREQuency[:EVENT]

Syntax :STATus:QUESTionable:FREQuency[:EVENT]?

Description Query the value of the event register for the questionable frequency status register.

Explanation The bit 1 to bit 15 of the questionable frequency status register are not used and will be always treated as 0. The range of the return value are the decimal numbers corresponding to the binary numbers ranging from 0000000000000000 (0 in decimal) to 0000000000000001 (1 in decimal).

Return Format The query returns the value of the event register of the questionable frequency status register in integer.

:STATus:QUESTionable:MODulation:CONDition

Syntax :STATus:QUESTionable:MODulation:CONDition?

Description Query the value of the condition register for the questionable modulation status register.

Explanation ➤ The relation between the modulation status register and questionable status register is as shown in the figure below.

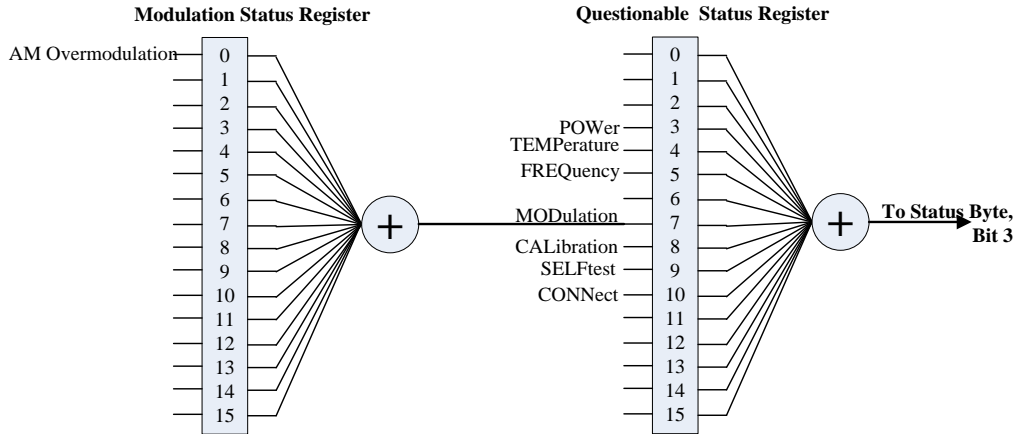

➤ The definitions of the questionable modulation status register are as shown in the table below. Wherein, bit 1 to bit 15 are not used and will be always treated as 0. The range of the return value are the decimal numbers corresponding to the binary numbers ranging from 0000000000000000 (0 in decimal) to 0000000000000001 (1 in decimal).

Bit	Value	Definition
0	1	AM Overmodulation
1	0	Not Used
2	0	Not Used
3	0	Not Used
4	0	Not Used
5	0	Not Used
6	0	Not Used
7	0	Not Used
8	0	Not Used
9	0	Not Used
10	0	Not Used
11	0	Not Used
12	0	Not Used
13	0	Not Used
14	0	Not Used
15	0	Not Used

Return Format The query returns the value of the condition register of the questionable modulation status register in integer.

:STATus:QUEStionable:MODulation:ENABle

Syntax :STATus:QUEStionable:MODulation:ENABle <value>

:STATus:QUEStionable:MODulation:ENABle?

Description Set the value of the enable register for the questionable modulation status register.

Query the value of the enable register for the questionable modulation status register.

Parameter	Name	Type	Range	Default
	<value>	Integer	Refer to the "Explanation"	0

Explanation In the questionable modulation status register, the range of <value> are the decimal numbers corresponding to the binary numbers ranging from 0000000000000000 (0 in decimal) to 1111111111111111 (32767 in decimal).

Return Format The query returns the value of the enable register of the questionable modulation status register in integer.

Example :STAT:QUES:MOD:ENAB 1

:STAT:QUES:MOD:ENAB?

:STATus:QUEStionable:MODulation[:EVENT]

Syntax :STATus:QUEStionable:MODulation[:EVENT]?

Description Query the value of the event register for the questionable modulation status register.

Explanation The bit 1 to bit 15 of the questionable modulation status register are not used and will be always treated as 0. The range of the return value are the decimal numbers corresponding to the binary numbers ranging from 0000000000000000 (0 in decimal) to 0000000000000001 (1 in decimal).

Return Format The query returns the value of the event register of the questionable modulation status register in integer.

:STATus:QUESTIONable:POWer:CONDition

Syntax :STATus:QUESTIONable:POWer:CONDition?

Description Query the value of the condition register for the questionable power status register.

Explanation ➤ The relation between the power status register and questionable status register is as shown in the figure below.

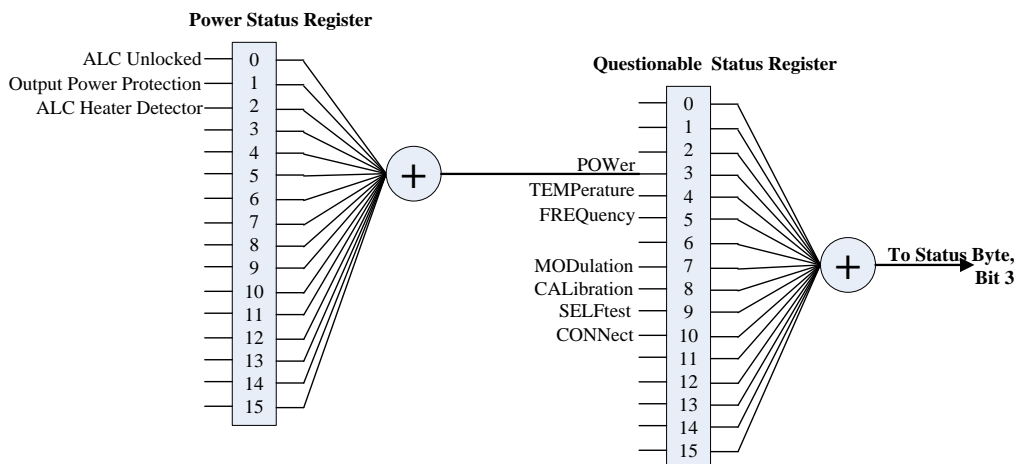

➤ The definitions of the questionable power status register are as shown in the table below. Wherein, bit 3 to bit 15 are not used and will be always treated as 0. The range of the return value are the decimal numbers corresponding to the binary numbers ranging from 0000000000000000 (0 in decimal) to 1111111111111111 (32767 in decimal) and of which the bit 3 to bit 15 are 0.

Bit	Value	Definition
0	1	ALC Unlocked
1	2	Output Power Protection
2	4	ALC Heater Detector, 30 min
3	0	Not Used
4	0	Not Used
5	0	Not Used
6	0	Not Used
7	0	Not Used
8	0	Not Used
9	0	Not Used
10	0	Not Used
11	0	Not Used
12	0	Not Used
13	0	Not Used
14	0	Not Used
15	0	Not Used

Return Format The query returns the value of the condition register of the questionable power status register in integer.

:STATus:QUEStionable:POWer:ENABle

Syntax :STATus:QUEStionable:POWer:ENABle <value>
:STATus:QUEStionable:POWer:ENABle?

Description Set the value of the enable register for the questionable power status register.
Query the value of the enable register for the questionable power status register.

Parameter	Name	Type	Range	Default
	<value>	Integer	Refer to the "Explanation"	0

Explanation In the questionable power status register, the range of <value> are the decimal numbers corresponding to the binary numbers ranging from 0000000000000000 (0 in decimal) to 1111111111111111 (32767 in decimal).

Return Format The query returns the value of the enable register of the questionable power status register in integer.

Example :STAT:QUES:POW:ENAB 6
:STAT:QUES:POW:ENAB?

:STATus:QUEStionable:POWer[:EVENT]

Syntax :STATus:QUEStionable:POWer[:EVENT]?

Description Query the value of the event register for the questionable power status register.

Explanation The bit 3 to bit 15 of the questionable power status register are not used and will be always treated as 0. The range of the return value are the decimal numbers corresponding to the binary numbers ranging from 0000000000000000 (0 in decimal) to 1111111111111111 (32767 in decimal) and of which the bit 3 to bit 15 are 0.

Return Format The query returns the value of the event register of the questionable power status register in integer.

:STATus:QUESTionable:SELFtest:CONDition

Syntax :STATus:QUESTionable:SELFtest:CONDition?

Description Query the value of the condition register for the questionable selftest status register.

Explanation ➤ The relation between the selftest status register and questionable status register is as shown in the figure below.

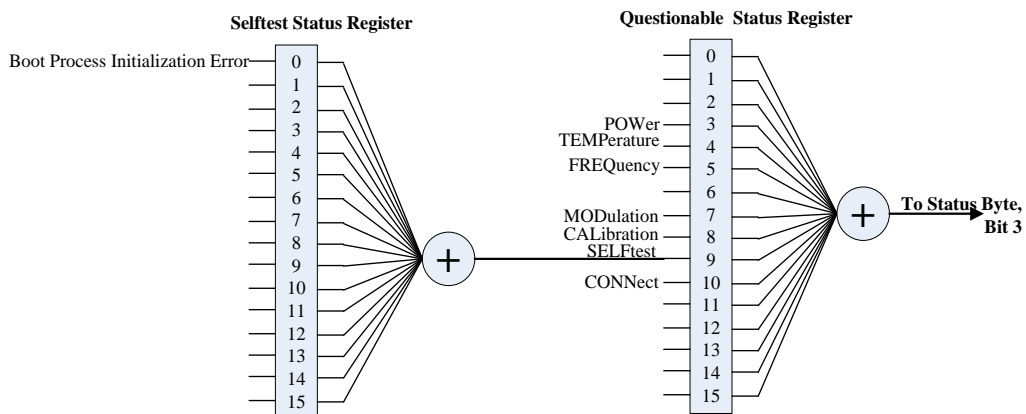

➤ The definitions of the questionable selftest status register are as shown in the table below. Wherein, bit 1 to bit 15 are not used and will be always treated as 0. The range of the return value are the decimal numbers corresponding to the binary numbers ranging from 0000000000000000 (0 in decimal) to 0000000000000001 (1 in decimal).

Bit	Value	Definition
0	1	Boot Process Initialization Error
1	0	Not Used
2	0	Not Used
3	0	Not Used
4	0	Not Used
5	0	Not Used
6	0	Not Used
7	0	Not Used
8	0	Not Used
9	0	Not Used
10	0	Not Used
11	0	Not Used
12	0	Not Used
13	0	Not Used
14	0	Not Used
15	0	Not Used

Return Format The query returns the value of the condition register of the questionable selftest status register in integer.

:STATus:QUEStionable:SELftest:ENABle

Syntax :STATus:QUEStionable:SELftest:ENABle <value>

:STATus:QUEStionable:SELftest:ENABle?

Description Set the value of the enable register for the questionable selftest status register.

Query the value of the enable register for the questionable selftest status register.

Parameter

Name	Type	Range	Default
<value>	Integer	Refer to the "Explanation"	0

Explanation In the questionable selftest status register, the range of <value> are the decimal numbers corresponding to the binary numbers ranging from 0000000000000000 (0 in decimal) to 1111111111111111 (32767 in decimal).

Return Format The query returns the value of the enable register of the questionable selftest status register in integer.

Example :STAT:QUES:SELF:ENAB 1

:STAT:QUES:SELF:ENAB?

:STATus:QUEStionable:SELftest[:EVENT]

Syntax :STATus:QUEStionable:SELftest[:EVENT]?

Description Query the value of the event register for the questionable selftest status register.

Explanation The bit 1 to bit 15 of the questionable selftest status register are not used and will be always treated as 0. The range of the return value are the decimal numbers corresponding to the binary numbers ranging from 0000000000000000 (0 in decimal) to 0000000000000001 (1 in decimal).

Return Format The query returns the value of the event register of the questionable selftest status register in integer.

:STATus:QUESTIONable:TEMP:CONDition

Syntax :STATus:QUESTIONable:TEMP:CONDition?

Description Query the value of the condition register for the questionable temperature status register.

Explanation ➤ The relation between the temperature status register and questionable status register is as shown in the figure below.

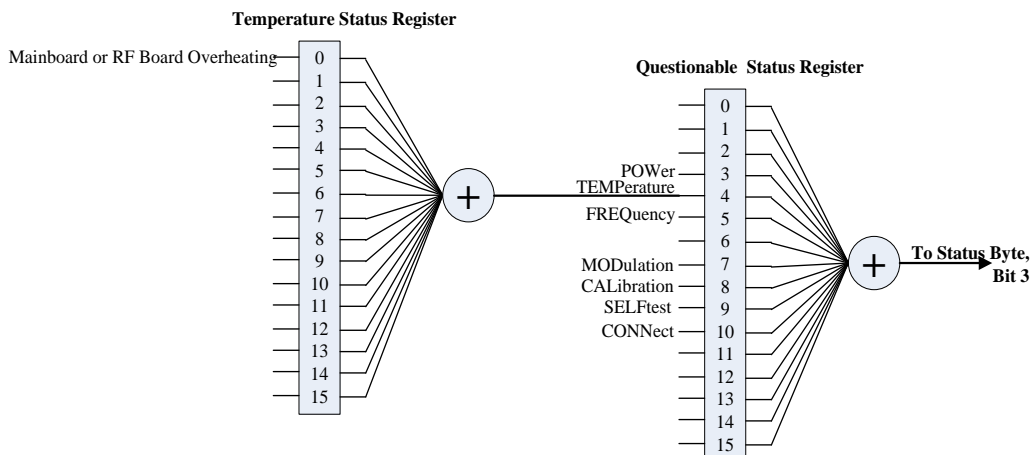

➤ The definitions of the questionable temperature status register are as shown in the table below. Wherein, bit 1 to bit 15 are not used and will be always treated as 0. The range of the return value are the decimal numbers corresponding to the binary numbers ranging from 0000000000000000 (0 in decimal) to 0000000000000001 (1 in decimal).

Bit	Value	Definition
0	1	Mainboard or RF Board Overheating
1	0	Not Used
2	0	Not Used
3	0	Not Used
4	0	Not Used
5	0	Not Used
6	0	Not Used
7	0	Not Used
8	0	Not Used
9	0	Not Used
10	0	Not Used
11	0	Not Used
12	0	Not Used
13	0	Not Used
14	0	Not Used
15	0	Not Used

Return Format The query returns the value of the condition register of the questionable temperature status register in integer.

:STATus:QUEStionable:TEMP:ENABLE

Syntax :STATus:QUEStionable:TEMP:ENABLE <value>

:STATus:QUEStionable:TEMP:ENABLE?

Description Set the value of the enable register for the questionable temperature status register.

Query the value of the enable register for the questionable temperature status register.

Parameter	Name	Type	Range	Default
	<value>	Integer	Refer to the "Explanation"	0

Explanation In the questionable temperature status register, the range of <value> are the decimal numbers corresponding to the binary numbers ranging from 0000000000000000 (0 in decimal) to 1111111111111111 (32767 in decimal).

Return Format The query returns the value of the enable register of the questionable temperature status register in integer.

Example :STAT:QUES:TEMP:ENAB 1

:STAT:QUES:TEMP:ENAB?

:STATus:QUEStionable:TEMP[:EVENT]

Syntax :STATus:QUEStionable:TEMP[:EVENT]?

Description Query the value of the event register for the questionable temperature status register.

Explanation The bit 1 to bit 15 of the questionable temperature status register are not used and will be always treated as 0. The range of the return value are the decimal numbers corresponding to the binary numbers ranging from 0000000000000000 (0 in decimal) to 0000000000000001 (1 in decimal).

Return Format The query returns the value of the event register of the questionable temperature status register in integer.

:SYSTem Commands

The :SYSTem commands are used to set a series of parameters relating to the system and the settings of these parameters do not affect the output signal of the RF signal generator.

Command List:

- ◆ [:SYSTem:BRIGhtness](#)
- ◆ [:SYSTem:CLEar](#)
- ◆ [:SYSTem:COMMunication:INTerface](#)
- ◆ [:SYSTem:COMMunication:LAN:DHCP](#)
- ◆ [:SYSTem:COMMunication:LAN:IP:ADDRESS](#)
- ◆ [:SYSTem:COMMunication:LAN:IP:AUTO](#)
- ◆ [:SYSTem:COMMunication:LAN:IP:GATeway](#)
- ◆ [:SYSTem:COMMunication:LAN:IP:MANual](#)
- ◆ [:SYSTem:COMMunication:LAN:IP:SET](#)
- ◆ [:SYSTem:COMMunication:LAN:IP:SUBnet:MASK](#)
- ◆ [:SYSTem:COMMunication:LAN:RESet](#)
- ◆ [:SYSTem:COMMunication:LAN\[:SELF\]:PREFerred](#)
- ◆ [:SYSTem:DATE](#)
- ◆ [:SYSTem:DISPlay:UPDate\[:STATE\]](#)
- ◆ [:SYSTem:FSWitch:STATE](#)
- ◆ [:SYSTem:LANGuage](#)
- ◆ [:SYSTem:LKEY](#)
- ◆ [:SYSTem:POWer:ON:TYPE](#)
- ◆ [:SYSTem:PRESet](#)
- ◆ [:SYSTem:PRESet:TYPE](#)
- ◆ [:SYSTem:PRESet:SAVE](#)
- ◆ [:SYSTem:TIME](#)

:SYSTem:BRIGhtness

Syntax :SYSTem:BRIGhtness <value>

:SYSTem:BRIGhtness?

Description Set the brightness of the LCD.

Query the brightness of the LCD.

Parameter

Name	Type	Range	Default
<value>	Integer	1 to 8	--

Explanation The "Brightness" setting will not be affected by factory reset.

Return Format The query returns an integer. For example, 3.

Example :SYST:BRIG 3

:SYST:BRIG?

:SYSTem:CLEAr

Syntax :SYSTem:CLEAr

Description Clear all the user-defined data.

Explanation The instrument will be reset to the factory setting after the data is cleared.

- Format the NAND FLASH;
- Reset the user data saved in NVRAM and NorFlash to the factory setting;
- Reset the HOST NAME, IP address and password in LXI to the factory setting.

:SYSTem:COMMunication:INTerface

Syntax :SYSTem:COMMunication:INTerface OFF|USB|LAN|GPIB|AUTO

:SYSTem:COMMunication:INTerface?

Description Set the communication interface.

Query the communication interface.

Parameter

Name	Type	Range	Default
OFF USB LAN GPIB AUTO	Discrete	OFF USB LAN GPIB AUTO	OFF

- Explanation**
- The parameter USB|LAN|GPIB|AUTO can set the communication interface to "USB", "LAN", "GPIB", or "Auto". When "OFF" is selected, all the communication interfaces are turned off.
 - If you are currently using a communication interface (for example, the USB interface), at this point, the query will always return the communication interface currently used no matter which type of communication interface you select.

Return Format The query returns the current communication interface. For example, USB.

Example :SYST:COMM:INT USB

:SYST:COMM:INT?

:SYSTem:COMMunication:LAN:DHCP

Syntax :SYSTem:COMMunication:LAN:DHCP ON|OFF|1|0

:SYSTem:COMMunication:LAN:DHCP?

Description Turn on or off the DHCP mode.

Query the state of the DHCP mode.

Parameter

Name	Type	Range	Default
ON OFF 1 0	Bool	ON OFF 1 0	ON 1

- Explanation**
- In DHCP mode, the DHCP server in the current network distributes network parameters (such as the IP address) for the instrument.
 - When all the three IP configuration modes are "On", the priority order of parameter configuration is "DHCP", "Auto-IP" and "Manual-IP".
 - The three IP configuration modes cannot be all set to "Off" at the same time.

Return Format The query returns 1 or 0.

Example :SYST:COMM:LAN:DHCP ON

:SYST:COMM:LAN:DHCP?

Related Commands [:SYSTem:COMMunication:LAN:IP:AUTO](#)
[:SYSTem:COMMunication:LAN:IP:MANual](#)

:SYSTem:COMMunication:LAN:IP:ADDRESS

Syntax :SYSTem:COMMunication:LAN:IP:ADDRESS <value>

:SYSTem:COMMunication:LAN:IP:ADDRESS?

Description Set the IP address.

Query the current IP address.

Parameter

Name	Type	Range	Default
<value>	ASCII string	The format is nnn.nnn.nnn.nnn; wherein, the range of the first nnn is from 1 to 223 (except 127) and the ranges of the other three nnn are from 0 to 255	--

- Explanation**
- This command is only valid when the Manual-IP configuration mode is turned on.
 - You are recommended to ask your network administrator for an address available.

Return Format The query returns the IP address. For example, 172.16.3.199.

Example :SYST:COMM:LAN:IP:ADD 172.16.3.199

:SYST:COMM:LAN:IP:ADD?

Related Command [:SYSTem:COMMunication:LAN:IP:MANual](#)

:SYSTem:COMMunication:LAN:IP:AUTO

Syntax :SYSTem:COMMunication:LAN:IP:AUTO ON|OFF|1|0
:SYSTem:COMMunication:LAN:IP:AUTO?

Description Turn on or off the Auto-IP configuration mode.
Query the state of the Auto-IP configuration mode.

Parameter	Name	Type	Range	Default
	ON OFF 1 0	Bool	ON OFF 1 0	ON 1

- Explanation**
- In the Auto-IP configuration mode, the instrument acquires an IP address within 169.254.0.1 and 169.254.255.254 and the subnet mask 255.255.0.0 automatically based on the current network configuration.
 - When all the three IP configuration modes are "On", the priority order of parameter configuration is "DHCP", "Auto-IP" and "Manual-IP".
 - The three IP configuration modes cannot be all set to "Off" at the same time.

Return Format The query returns 1 or 0.

Example :SYST:COMM:LAN:IP:AUTO ON
:SYST:COMM:LAN:IP:AUTO?

Related Commands [:SYSTem:COMMunication:LAN:DHCP](#)
[:SYSTem:COMMunication:LAN:IP:MANual](#)

:SYSTem:COMMunication:LAN:IP:GATeway

Syntax :SYSTem:COMMunication:LAN:IP:GATeway <string>
:SYSTem:COMMunication:LAN:IP:GATeway?

Description Set the default gateway.
Query the current default gateway.

Parameter	Name	Type	Range	Default
	<string>	ASCII string	The format is nnn.nnn.nnn.nnn; wherein, the range of the first nnn is from 1 to 223 (except 127) and the ranges of the other three nnn are from 0 to 255	--

- Explanation**
- This command is only valid when the Manual-IP configuration mode is turned on.
 - You are recommended to ask your network administrator for an address available.

Return Format The query returns the default gateway. For example, 172.16.3.1.

Example :SYST:COMM:LAN:IP:GAT 172.16.3.1
:SYST:COMM:LAN:IP:GAT?

Related Command [:SYSTem:COMMunication:LAN:IP:MANual](#)

:SYSTem:COMMunication:LAN:IP:MANual

Syntax :SYSTem:COMMunication:LAN:IP:MANual ON|OFF|1|0
:SYSTem:COMMunication:LAN:IP:MANual?

Description Turn on or off the Manual-IP configuration mode.

Query the status of the Manual-IP configuration mode.

Parameter	Name	Type	Range	Default
	ON OFF 1 0	Bool	ON OFF 1 0	OFF 0

- Explanation**
- In the Manual-IP configuration mode, the network parameters (such as the IP address) are defined by users.
 - When all the three IP configuration modes are "On", the priority order of parameter configuration is "DHCP", "Auto-IP" and "Manual-IP".
 - The three IP configuration modes cannot be all set to "Off" at the same time.

Return Format The query returns 1 or 0.

Example :SYST:COMM:LAN:IP:MAN ON
:SYST:COMM:LAN:IP:MAN?

Related Commands [:SYSTem:COMMunication:LAN:DHCP](#)
[:SYSTem:COMMunication:LAN:IP:AUTO](#)

:SYSTem:COMMunication:LAN:IP:SET

Syntax :SYSTem:COMMunication:LAN:IP:SET

Description Apply the current network parameter settings.

Explanation After setting the LAN parameters, you have to execute this command to apply the parameters. Otherwise, the settings are invalid.

:SYSTem:COMMunication:LAN:IP:SUBnet:MASK

Syntax :SYSTem:COMMunication:LAN:IP:SUBnet:MASK <value>
:SYSTem:COMMunication:LAN:IP:SUBnet:MASK?

Description Set the subnet mask.

Query the current subnet mask.

Parameter	Name	Type	Range	Default
	<value>	ASCII string	The format is nnn.nnn.nnn.nnn and the range of the nnn is from 0 to 255.	--

- Explanation**
- This command is only valid when the Manual-IP configuration mode is turned on.
 - You are recommended to ask your network administrator for a subnet mask available.

Return Format The query returns the subnet mask. For example, 255.255.255.0.

Example :SYST:COMM:LAN:IP:SUB:MASK 255.255.255.0
:SYST:COMM:LAN:IP:SUB:MASK?

Related Command [:SYSTem:COMMunication:LAN:IP:MANual](#)

:SYSTem:COMMunication:LAN:RESet

Syntax :SYSTem:COMMunication:LAN:RESet

Description Reset the current network parameters.

Explanation After resetting the current parameters, DHCP and Auto-IP are turned on and Manual-IP is turned off.

:SYSTem:COMMunication:LAN[:SELF]:PREFferred

Syntax :SYSTem:COMMunication:LAN[:SELF]:PREFferred <value>
:SYSTem:COMMunication:LAN[:SELF]:PREFferred?

Description Set the DNS (Domain Name Service).

Query the current DNS.

Parameter	Name	Type	Range	Default
	<value>	ASCII string	The format is nnn.nnn.nnn.nnn, wherein, the range of the first nnn is from 1 to 223 (except 127) and the ranges of the other three nnn are from 0 to 255	--

Explanation You are recommended to ask your network administrator for an address available.

Return Format The query returns the DNS address. For example, 172.16.2.3.

Example :SYST:COMM:LAN:PREF 172.16.2.3
:SYST:COMM:LAN:PREF?

:SYSTem:DATE

Syntax :SYSTem:DATE <year>,<month>,<day>
:SYSTem:DATE?

Description Set the date of the instrument.

Query the date of the instrument.

Parameter	Name	Type	Range	Default
	<year>	ASCII string	2000 to 2099	--
	<month>	ASCII string	01 to 12	--
	<day>	ASCII string	01 to 31	--

Return Format The query returns the current date in "YYYY,MM,DD" format. For example, 2020,08,31.

Example :SYST:DATE 2020,08,31
:SYST:DATE?

:SYSTem:DISPlay:UPDate[:STATe]

Syntax :SYSTem:DISPlay:UPDate[:STATe] ON|OFF|1|0
:SYSTem:DISPlay:UPDate[:STATe]?

Description Set the on/off state of the screen.

Query the on/off state of the screen.

Parameter	Name	Type	Range	Default
	ON OFF 1 0	Bool	ON OFF 1 0	ON 1

Explanation When the screen is turned off, the screen stops updating and is locked. At this point, the measurement speed is improved. You can press **ESC** to unlock the screen. Screen locking is mainly used in remote operation mode.

Return Format The query returns 1 or 0.

Example :SYST:DISP:UPD OFF
:SYST:DISP:UPD?

:SYSTem:FSWitch:STATe

Syntax :SYSTem:FSWitch:STATe OPEN|DEFAult
:SYSTem:FSWitch:STATe?

Description Set the power status of the RF signal generator after power-on.

Query the power status of the RF signal generator after power-on.

Parameter	Name	Type	Range	Default
	OPEN DEFAult	Discrete	OPEN DEFAult	--

Explanation

- OPEN: select "Open" state. The RF signal generator starts automatically after power-on.
- DEFAult: select "Default" state. You have to press the power key on the front panel to start the RF signal generator after power-on.

Return Format The query returns Open or Default.

Example :SYST:FSW:STAT OPEN
:SYST:FSW:STAT?

:SYSTem:LANGuage

Syntax :SYSTem:LANGuage CHINese|ENGLish
:SYSTem:LANGuage?

Description Set the system language.

Query the system language.

Parameter	Name	Type	Range	Default
	CHINese ENGLish	Discrete	CHINese ENGLish	--

Return Format The query returns CHINESE or ENGLISH.

Example :SYST:LANG CHIN
:SYST:LANG?

:SYSTem:LKEY

Syntax :SYSTem:LKEY <license key>
:SYSTem:LKEY? <option>

Description Install and activate the option of the instrument.
Query the license of the option installed.

Parameter	Name	Type	Range	Default
	<license key>	String	License of the option you bought	--
	<option>	Integer	1	--

- Explanation**
- The license for each option is unique and can only be used by one instrument (namely, the license of the option corresponds to the serial number of the instrument you bought).
 - 1 corresponds to DSG3000B-PUG.

Example :SYST:LKEY JAVX3HDBQALKVSTDMAX2QJSMBBQT
:SYST:LKEY? 1

:SYSTem:POWer:ON:TYPE

Syntax :SYSTem:POWer:ON:TYPE LAST|PRESet
:SYSTem:POWer:ON:TYPE?

Description Select the instrument configuration to be used at start-up.
Query the instrument configuration to be used at start-up.

Parameter	Name	Type	Range	Default
	LAST PRESet	Discrete	LAST PRESet	--

- Explanation**
- LAST: the instrument loads the system configuration used before the last power-off automatically at start-up.
 - PRESet: the instrument loads the settings defined by the [:SYSTem:PRESet:TYPE](#) command automatically at start-up.

Return Format The query returns LAST or PRESET.

Example :SYST:POW:ON:TYPE LAST
:SYST:POW:ON:TYPE?

Related Command [:SYSTem:PRESet:TYPE](#)

:SYSTem:PRESet

Syntax :SYSTem:PRESet

Description Reset the instrument to the preset state (the settings (FACTory or USER) defined by the [:SYSTem:PRESet:TYPE](#) command).

Explanation Sending this command is equivalent to pressing **Preset** on the front panel, namely recalling the default values or user-preset values related to this key.

Related Commands [:SYSTem:POWER:ON:TYPE](#)
[:SYSTem:PRESet:TYPE](#)

:SYSTem:PRESet:TYPE

Syntax :SYSTem:PRESet:TYPE FACTory|USER
 :SYSTem:PRESet:TYPE?

Description Select the preset type of the system.

Query the preset type of the system.

Parameter	Name	Type	Range	Default
	FACTory USER	Discrete	FACTory USER	--

Explanation

- When the power-on setting is set to "Preset", the instrument loads the specified preset type ("Factory" or "User") after start-up.
- Pressing **Preset** on the front panel will recall the specified preset type.
- When the preset type is set to "User", you can use the [:SYSTem:PRESet:SAVE](#) command to save the current system configuration.

Return Format The query returns FACTORY or USER.

Example :SYST:PRESet:TYPE USER
 :SYST:PRESet:TYPE?

Related Commands [:SYSTem:POWER:ON:TYPE](#)
[:SYSTem:PRESet:SAVE](#)

:SYSTem:PRESet:SAVE

Syntax :SYSTem:PRESet:SAVE

Description Save the user setting.

Explanation

- Using this command can save the current system configuration as user-defined setting in the internal non-volatile memory.
- When **Preset Type** is set to "User" (use the [:SYSTem:PRESet:TYPE](#) command), this configuration will be loaded when recalling "Preset" (use the [:SYSTem:POWER:ON:TYPE](#) command).
- When **Preset Type** is set to "Factory", this command is invalid.

Related Commands [:SYSTem:POWER:ON:TYPE](#)
[:SYSTem:PRESet:TYPE](#)

:SYSTem:TIME

Syntax :SYSTem:TIME <hour>,<min>,<sec>

:SYSTem:TIME?

Description Set the time of the instrument.

Query the time of the instrument.

Parameter

Name	Type	Range	Default
<hour>	ASCII string	00 to 23	--
<min>	ASCII string	00 to 59	--
<sec>	ASCII string	00 to 59	--

Return Format The query returns the current time in "hh,mm,ss" format. For example, 16,40,30.

Example SYST:TIME 16,40,30

SYST:TIME?

:SYSTem:TIME:STATe

Syntax :SYSTem:TIME:STATe ON|OFF

:SYSTem:TIME:STATe?

Description Set the on/off status of the display of the time and date.

Query the on/off status of the display of the time and date.

Parameter

Name	Type	Range	Default
ON OFF	Bool	ON OFF	OFF

- Explanation**
- ON: turn on the display of the time and date.
 - OFF: turn off the display of the time and date.

Return Format The query returns ON or OFF.

Example SYST:TIME:STAT ON

SYST:TIME:STAT?

:TRIGger Commands

Command List:

- ◆ [:TRIGger:IQ\[:IMMediate\]](#)
- ◆ [:TRIGger:PULSe\[:IMMediate\]](#)
- ◆ [:TRIGger\[:SWEep\]\[:IMMediate\]](#)

:TRIGger:IQ[:IMMediate]

Syntax :TRIGger:IQ[:IMMediate]

Description Trigger an IQ wavetable output immediately.

Explanation When the "Trig Mode" of IQ wavetable is set to "Bus", the instrument starts outputting an IQ baseband signal each time this command is sent.

Example :TRIG:IQ

Related Command [*TRG](#)

:TRIGger:PULSe[:IMMediate]

Syntax :TRIGger:PULSe[:IMMediate]

Description Trigger a pulse modulation immediately.

Explanation When the "Trig Mode" of pulse modulation is set to "Bus", the instrument starts a pulse modulation each time this command is sent.

Example :TRIG:PULS

Related Command [*TRG](#)

:TRIGger[:SWEep][:IMMediate]

Syntax :TRIGger[:SWEep][:IMMediate]

Description Trigger a RF sweep immediately.

Explanation When the "Trig Mode" or "Point Trig" mode of SWEEP is set to "Bus" and the corresponding trigger condition is met, the instrument starts a RF sweep within the sweep period or sweeps a point and then stops each time this command is sent.

Example :TRIG:SWE

Related Command [*TRG](#)

:UNIT Command

Command List:

◆ [:UNIT:POWer](#)

:UNIT:POWer

Syntax :UNIT:POWer DBM|DBMV|DBUV|V|W
:UNIT:POWer?

Description Set the output and display unit of the amplitude.
Query the output and display unit of the amplitude.

Parameter

Name	Type	Range	Default
DBM DBMV DBUV V W	Discrete	DBM DBMV DBUV V W	DBM

Return Format The query returns DBM, DBMV, DBUV, V or W.

Example :UNIT:POW V
:UNIT:POW?

Chapter 3 Application Examples

This chapter provides some application examples of the SCPI commands. A series of SCPI commands are combined to realize the main functions of the RF signal generator.

Note:

1. The examples in this chapter are based on DSG836. For other models, the ranges of some parameters might be different. When using the commands, please make proper adjustment according to the model of your instrument.
2. Before using the examples in this chapter, please select the desired communication interface (USB, LAN, or USB-GPIB) and make correct connections (refer to the introductions in [To Build Remote Communication](#)). Besides, you have to install Ultra Sigma or other PC software for sending commands on your PC.
3. The content enclosed in "/"* and "*/" after each command in the application examples in this chapter is annotation for easier understanding and is not a part of the command.

Main topics of this chapter:

- ◆ [To Output RF signal](#)
- ◆ [To Output RF Sweep Signal](#)
- ◆ [To Output RF Modulated Signal](#)

To Output RF signal

Requirement

Use the SCPI commands to realize the following functions:

Output a RF signal with 1GHz frequency and -20dBm amplitude from the **[RF OUTPUT 50Ω]** connector.

Method

- | | | |
|----|---------------------|--|
| 1. | *IDN? | /*Query the ID string of the RF signal generator to check whether the remote communication is normal*/ |
| 2. | :SYST:PRES:TYPE FAC | /*Set the preset type to "Factory"*/ |
| 3. | :SYST:PRES | /*Restore the instrument to the factory setting*/ |
| 4. | :FREQ 1GHz | /*Set the RF signal frequency to 1GHz*/ |
| 5. | :LEV -20 | /*Set the RF signal amplitude to -20dBm*/ |
| 6. | :OUTP ON | /*Turn on the RF output*/ |

To Output RF Sweep Signal

Requirement

Use the SCPI commands to realize the following functions:

Output a RF sweep signal from the **[RF OUTPUT 50Ω]** connector by configuring continuous linear step sweep. Set the frequency range to 1GHz to 2GHz, the amplitude range to -20dBm to 0dBm, the number of sweep points to 10 and the dwell time to 500ms.

Method

- | | | |
|-----|--------------------------|--|
| 1. | *IDN? | /*Query the ID string of the RF signal generator to check whether the remote communication is normal*/ |
| 2. | :SYST:PRES:TYPE FAC | /*Set the preset type to "Factory"*/ |
| 3. | :SYST:PRES | /*Restore the instrument to the factory setting (by default, the sweep mode is continuous, the sweep type is step and the sweep spacing is linear)*/ |
| 4. | :SWE:STEP:STAR:FREQ 1GHz | /*Set the start frequency of step sweep to 1GHz*/ |
| 5. | :SWE:STEP:STOP:FREQ 2GHz | /*Set the stop frequency of step sweep to 2GHz*/ |
| 6. | :SWE:STEP:STAR:LEV -20 | /*Set the start level of step sweep to -20dBm*/ |
| 7. | :SWE:STEP:STOP:LEV 0 | /*Set the stop level of step sweep to 0dBm*/ |
| 8. | :SWE:STEP:POIN 10 | /*Set the number of step sweep points to 10*/ |
| 9. | :SWE:STEP:DWEL 500ms | /*Set the dwell time of step sweep to 500ms*/ |
| 10. | :SWE:STAT LEV,FREQ | /*Turn on the frequency and level sweep functions at the same time*/ |
| 11. | :OUTP ON | /*Turn on the RF output*/ |

To Output RF Modulated Signal

Requirement

Use the SCPI commands to realize the following functions:

Output an AM modulated signal. Set the carrier frequency to 800MHz, the carrier amplitude to -20dBm, the AM modulation depth to 60% and the modulation frequency to 20kHz.

Method

1. *IDN? /*Query the ID string of the RF signal generator to check whether the remote communication is normal*/
2. :SYST:PRES:TYPE FAC /*Set the preset type to "Factory"*/
3. :SYST:PRES /*Restore the instrument to the factory setting (by default, the modulation source is internal and the modulation waveform is sine)*/
4. :FREQ 800MHz /*Set the RF carrier frequency to 800MHz*/
5. :LEV -20 /*Set the RF carrier amplitude to -20dBm*/
6. :AM:DEPT 60 /*Set the AM modulation depth to 60%*/
7. :AM:FREQ 20kHz /*Set the AM modulation frequency to 20kHz*/
8. :AM:STAT ON /*Turn on the AM function*/
9. :MOD:STAT ON /*Turn on the RF modulation*/
10. :OUTP ON /*Turn on the RF output*/

Note: The **RF** and **MOD** switches must be turned on.

Chapter 4 Programming Demos

This chapter provides the demos for programming and controlling the RF signal generator using SCPI commands under Excel, Matlab, LabVIEW, Visual Basic and Visual C++ environment on the basis of NI-VISA.

NI-VISA (National Instrument-Virtual Instrument Software Architecture) is an advanced application programming interface developed by NI (National Instrument) for communicating with various instrument buses. It can communicate with the instrument in the same method regardless of the type of the instrument interface (USB or LAN/Ethernet).

The instrument communicating with NI-VISA via various interfaces is called "resource". The VISA descriptor (namely the "resource name") is used to describe the accurate name and location of the VISA resource. If LAN interface is currently used for communicating with the instrument, the VISA descriptor is :TCPIP0::172.16.3.199::INSTR. Before programming, please acquire the correct VISA descriptor.

Main topics of this chapter:

- ◆ [Programming Preparations](#)
- ◆ [Excel Programming Demo](#)
- ◆ [Matlab Programming Demo](#)
- ◆ [LabVIEW Programming Demo](#)
- ◆ [Visual Basic Programming Demo](#)
- ◆ [Visual C++ Programming Demo](#)

Programming Preparations

Before programming, you need to make the following preparations.

1. Make sure that your PC has been installed with the NI-VISA library (can be downloaded from the NI website: <http://www.ni.com/visa>). Here, the default installation path is C:\Program Files\IVI Foundation\VISAs.
2. In this manual, the USB interface of the RF signal generator is used to communicate with the PC and please use a USB cable to connect the USB DEVICE interface on the rear panel of the RF signal generator to the PC.
3. Turn on the instrument after correctly connecting the RF signal generator and PC.
4. At this point, the "**Found New Hardware Wizard**" dialog box appears on the PC. Please follow the instructions to install the "USB Test and Measurement Device (IVI)".

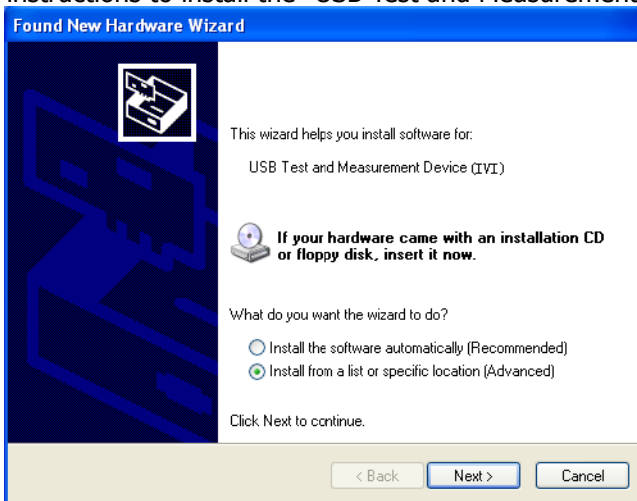

5. Acquire the USB VISA descriptor of the RF signal generator: run Ultra Sigma and search for the RF signal generator resource currently connected to the PC. The resource found is displayed under the "RIGOL Online Resource" directory, including the instrument model and the USB interface information (namely the VISA descriptor) as shown in the figure below. Here, the VISA descriptor of the RF signal generator is USB0::0x1AB1::0x099C::DSG3G223200001::INSTR.

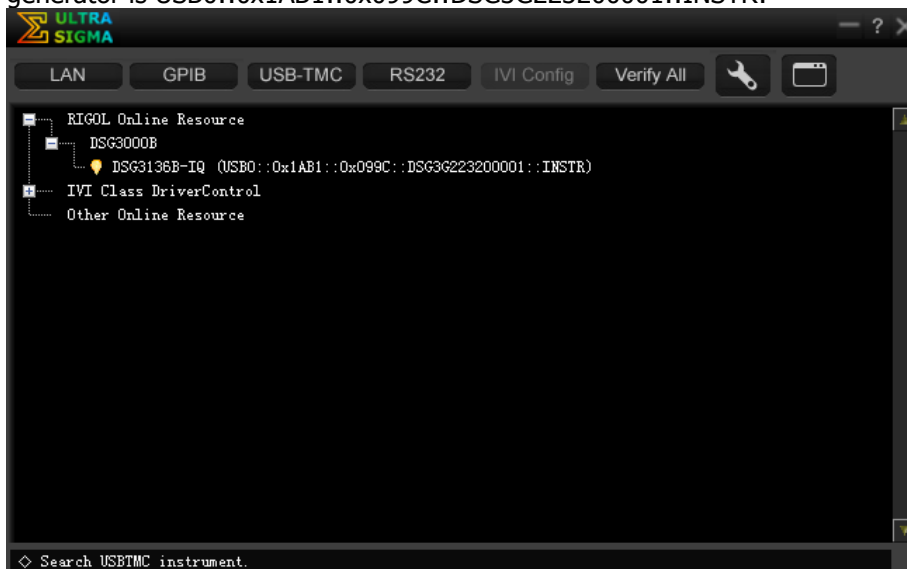

By now, the programming preparations are finished.

Excel Programming Demo

The program used in this demo: Microsoft Excel 2010

The functions realized in this demo: send the *IDN? Command to read the device information.

1. Create a new Excel file that enables the Macro. In this example, the file is named as DSG3000B_Demo_Excel.xlsm.
2. Run DSG3000B_Demo_Excel.xlsm. Click **File** → **Options** at the upper-left corner of the Excel file to open the interface as shown in the figure below. Click **Customize Ribbon** at the left, check **Developer** and click **OK**. At this point, the Excel menu bar displays the **Developer** menu.

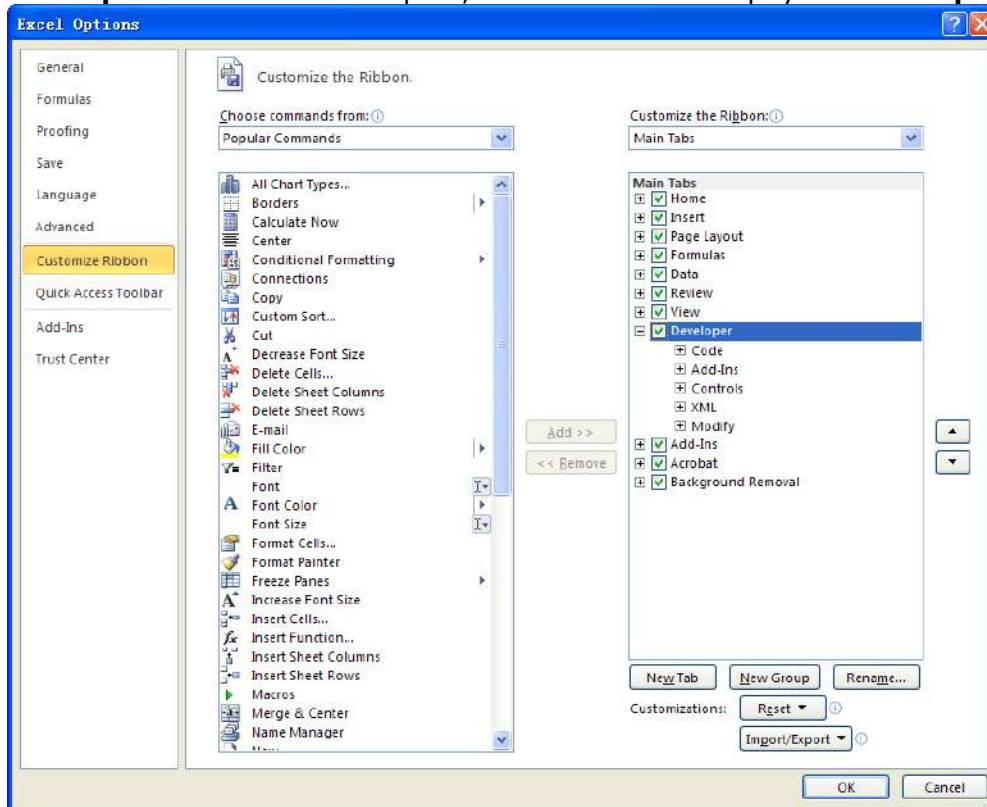

3. Input the VISA descriptor into a cell of the file as shown in the figure below. Click the **Developer** menu and select the **Visual Basic** option to open the Microsoft Visual Basic.

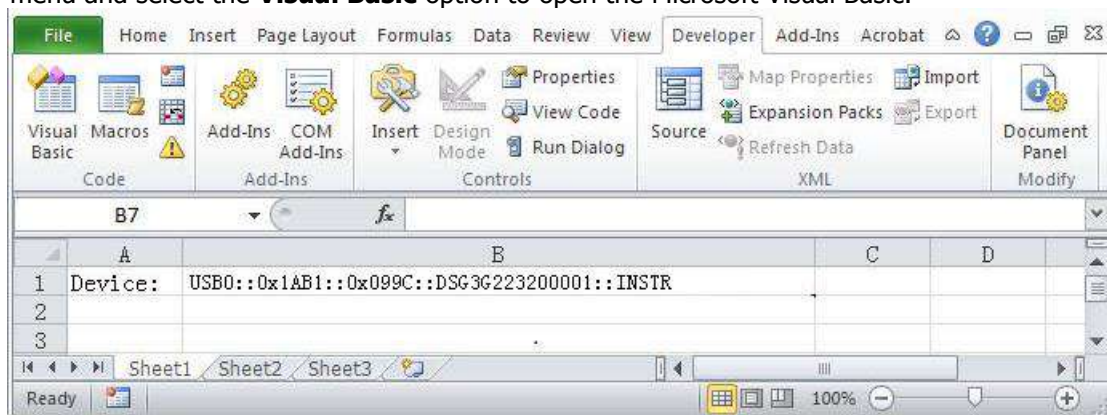

4. Select **Tools** in the Microsoft Visual Basic menu bar and click **References**.



Select **VISA Library** in the pop-up dialog box and click **OK** to refer to the VISA Library.

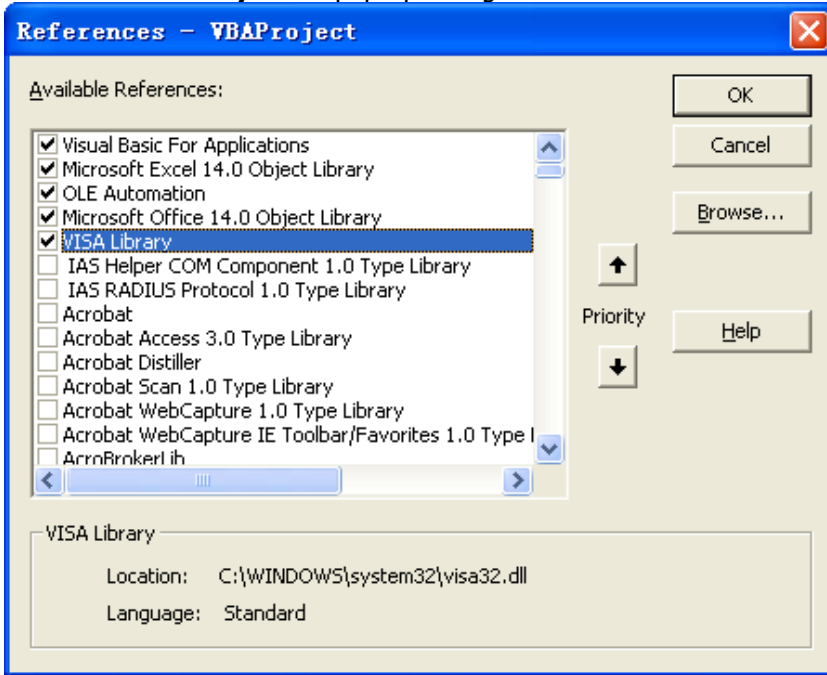

Explanation:

If you cannot find the VISA Library in the left list in the figure above, please try to find it using the following method.

- (1) Make sure that you have installed the NI-VISA library on your PC.
- (2) Click **Browse...** at the right and set the search range to **C:\WINDOWS\system32** and the filename to **visa32.dll**, as shown in the figure below.

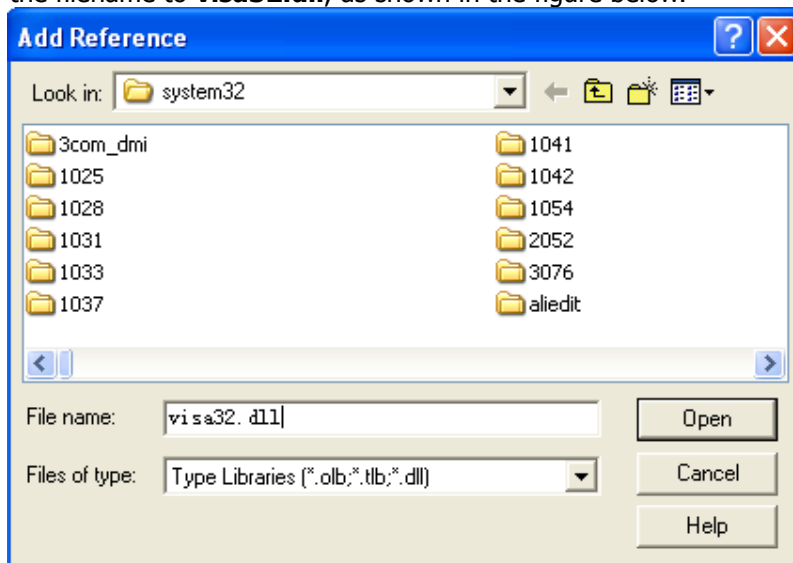

5. Click **View Code** in the **Developer** menu to enter the Microsoft Visual Basic interface. Add the

following codes and save the file.

Note: If the Excel file created at step 2 does not enable the Macros, at this point, the prompt message "The following features cannot be saved in macro-free workbooks" will be displayed. In this situation, please save the Excel file as a file using the Macros.

Sub QueryIdn()

```
Dim viDefRm As Long
Dim viDevice As Long
Dim viErr As Long
Dim cmdStr As String
Dim idnStr As String * 128
Dim ret As Long
```

'Turn on the device. The device resource descriptor is in CELLS(1,2) of SHEET1'

```
viErr = visa.viOpenDefaultRM(viDefRm)
viErr = visa.viOpen(viDefRm, Sheet1.Cells(1, 2), 0, 5000, viDevice)
```

'Send request to read data. The return value is in CELLS(2,2) of SHEET1'

```
cmdStr = "*IDN?"
viErr = visa.viWrite(viDevice, cmdStr, Len(cmdStr), ret)
viErr = visa.viRead(viDevice, idnStr, 128, ret)
Sheet1.Cells(2, 2) = idnStr
```

'Turn off the device'

```
visa.viClose (viDevice)
visa.viClose (viDefRm)
```

End Sub

6. Add button control: click **Insert** in the **Developer** menu, select the desired button in **Form Controls** and put it into the cell of the Excel. At this point, the **Assign Macro** interface is displayed, select "Sheet1.QueryIdn" and click **OK**.

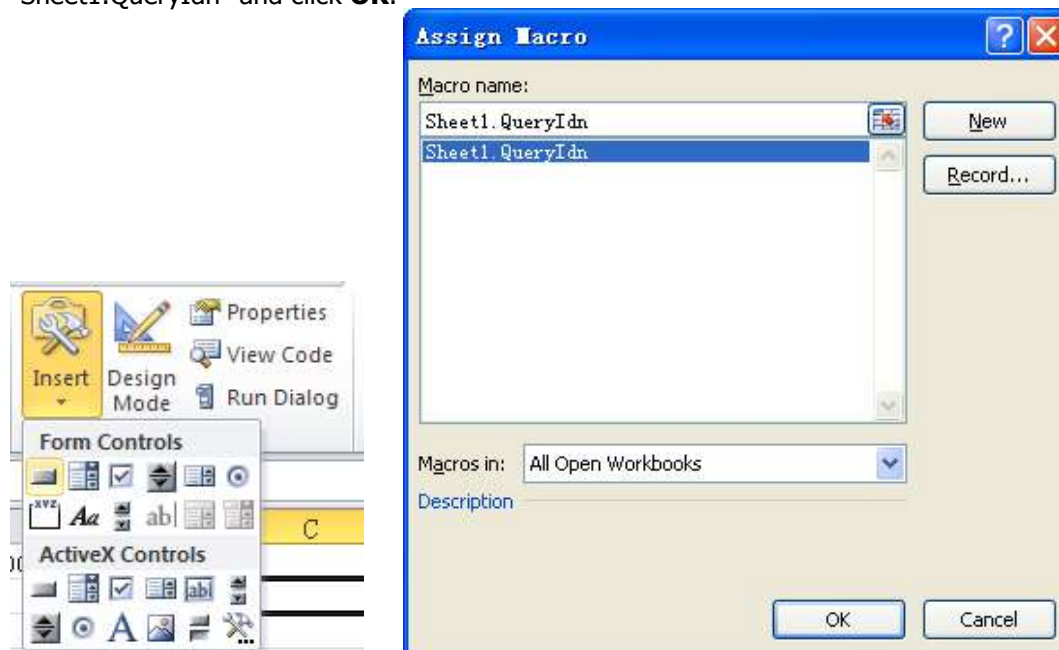

By default, the button name is "Button 1". Right-click the button and select **Edit Text** in the pop-up menu to change the button name to "*IDN?".

7. Click the "*IDN?" button to run the program. The device information of the RF signal generator is as shown in the figure below.

A	B	C
Device:	USB0::0x1AB1::0x099C::DSG3G223200001::INSTR	*IDN?
	Rigol Technologies,DSG3136B-IQ,DSG3G223200001,00.01.00	

Matlab Programming Demo

The program used in this demo: MATLAB R2009a

The functions realized in this demo: read the current frequency and amplitude of the RF signal generator.

1. Run Matlab and modify the current directory (namely modify the **Current Directory** at the top of the software). In this example, the current directory is changed to D:\DSG3000B_Demo.



2. Click **File** → **New** → **Blank M-File** in the Matlab interface to create a blank M file.
3. Add the following codes in the M file.

```
DSG3000B = visa( 'ni','USB0::0x1AB1::0x099C::DSG3G223200001::INSTR' ); %Create Visa object
fopen( DSG3000B ); %Open the visa object created
fprintf(DSG3000B, ':FREQ?' ); %Send request to query the frequency
meas_RF_FREQ = fscanf(DSG3000B); %Read the frequency data
fprintf(DSG3000B, ':LEV?' ); %Send request to query the amplitude
meas_RF_LEV = fscanf(DSG3000B); %Read the amplitude data
fclose(DSG3000B); %Close the visa object
display(meas_RF_FREQ); %Display the frequency read
display(meas_RF_LEV) %Display the amplitude read
```

4. Save the M file in the current directory. In this example, the M file is named as DSG3000B_Demo_MATLAB.m.
5. Run the M file and the command window displays the following results.

```
meas_RF_FREQ =
1.500 000 000 00GHz

meas_RF_LEV =
-20.00
```

The results above denote that the current frequency of the RF signal generator is 1.5GHz and the amplitude is -20dBm.

LabVIEW Programming Demo

The program used in this demo: LabVIEW 2009

The functions realized in this demo: search for the instrument address, connect the instrument, send command and read the return value.

1. Run LabVIEW 2009. Create a new VI file and name it as DSG3000B_Demo_LABVIEW.
2. Add controls in the front panel interface, including the address bar, command bar and return bar as well as the Connect, Write, Read and Exit buttons.

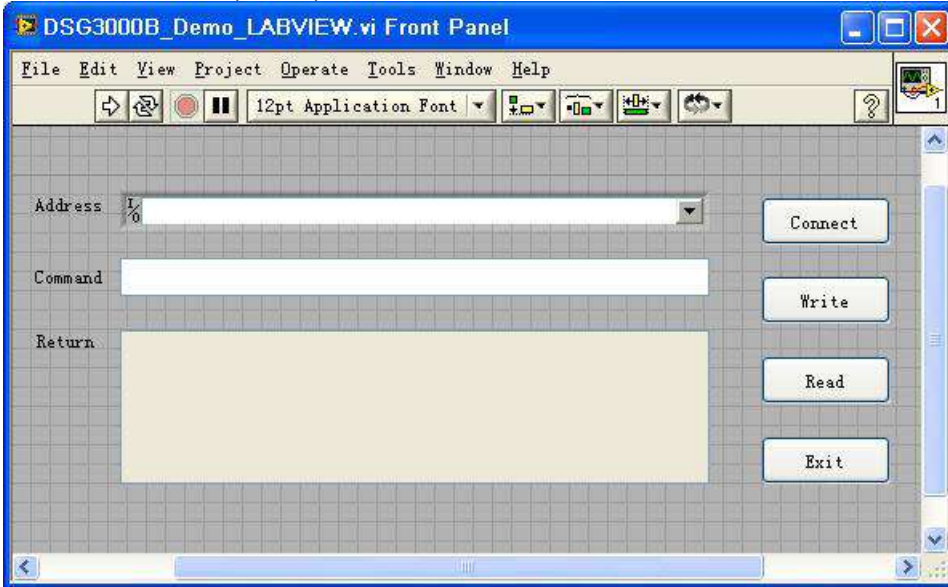

3. Click **Show Block Diagram** in the Window menu and add the While cycle to create the event structure.

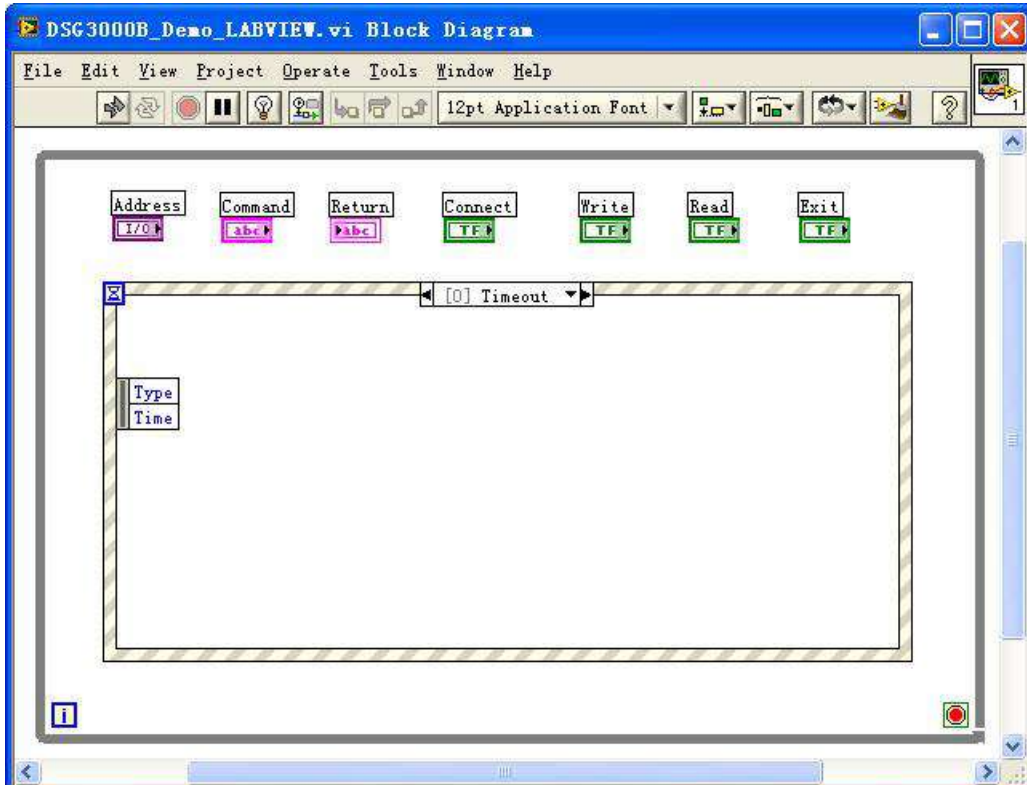

4. Add events, including connect the instrument, write operation, read operation and exit.
 - (1) Connect the instrument (include error processing).

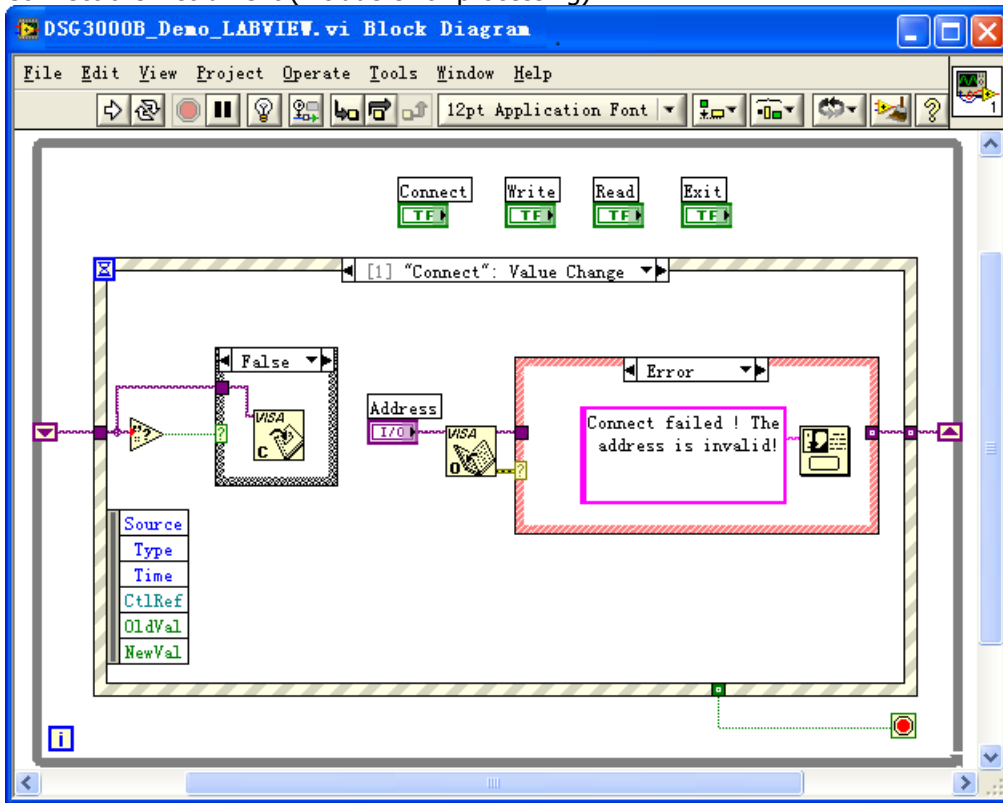

- (2) Write operation (include error judgment).

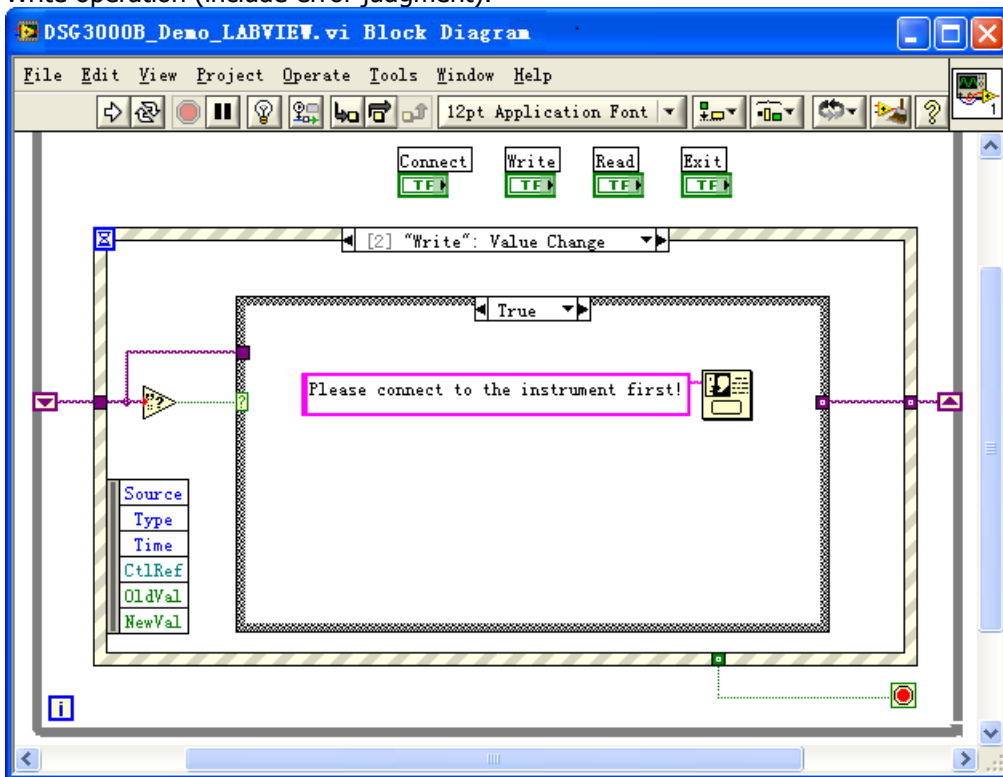

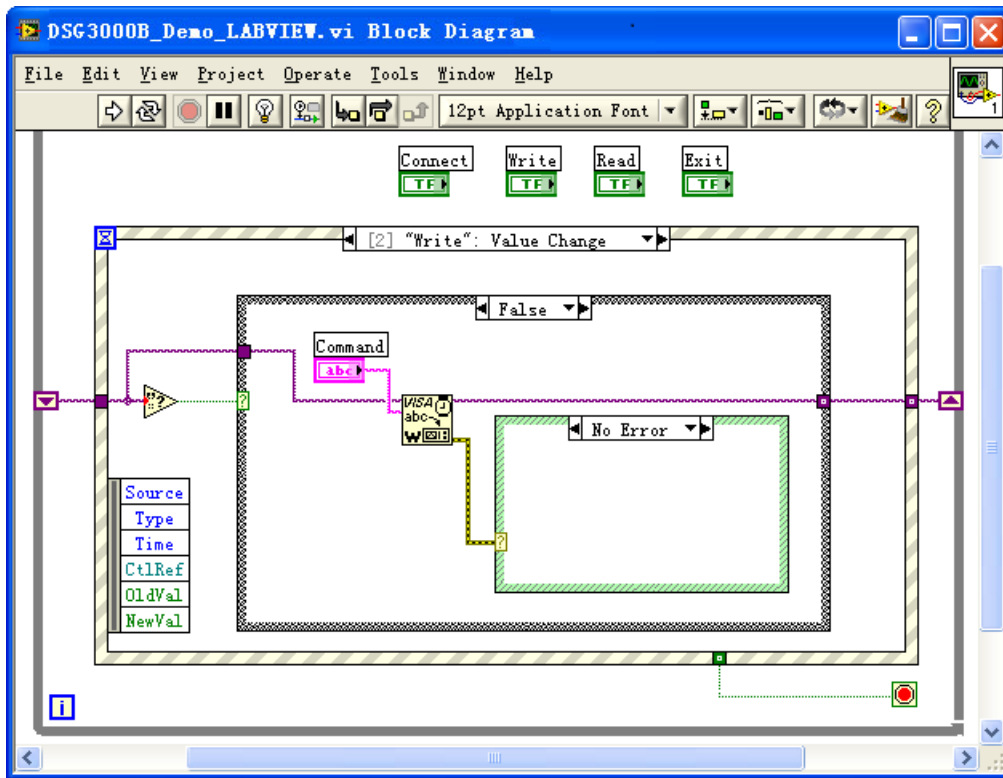

(3) Read operation (include error processing).

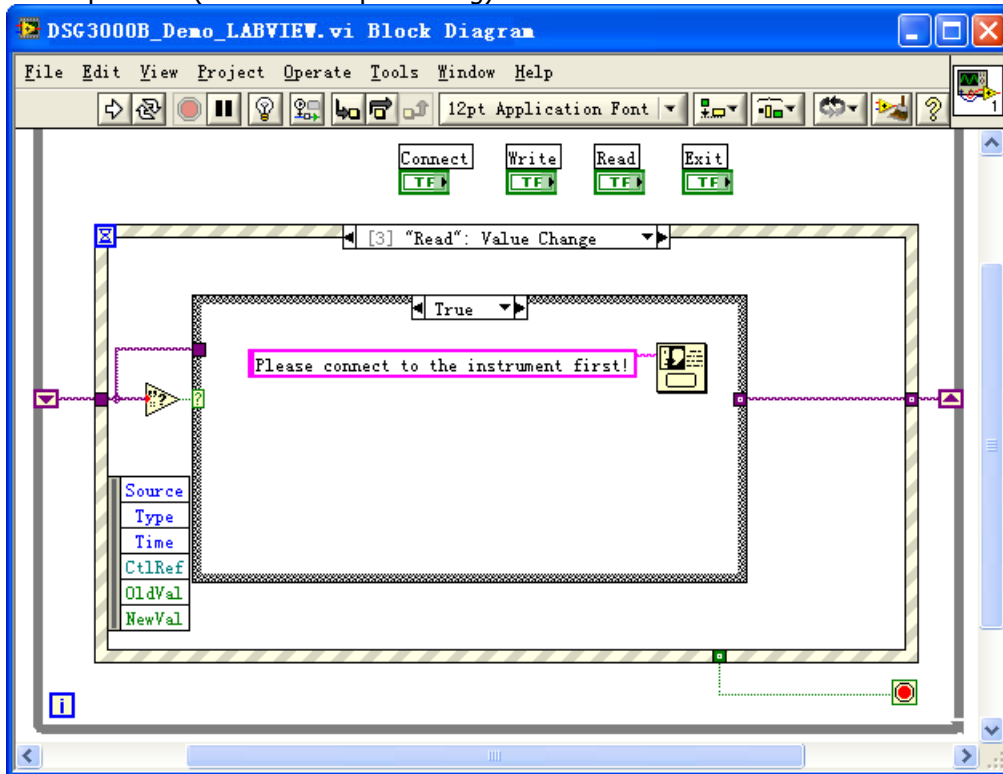

(4) Exit.

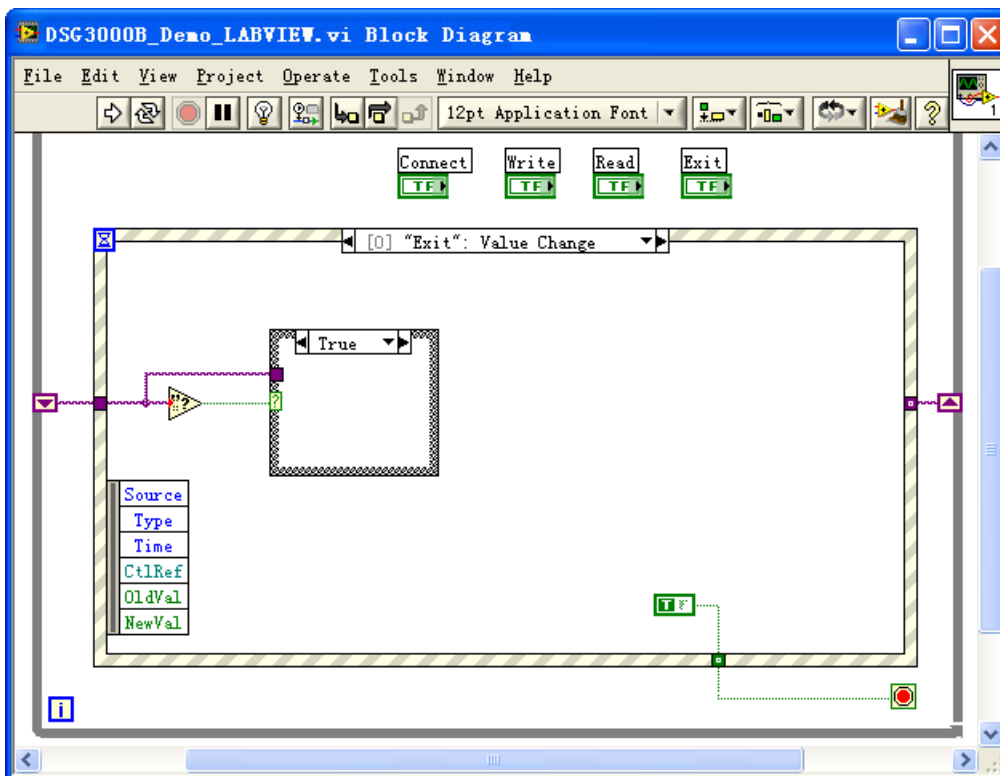

- Run the program and the interface as shown below is displayed. Click the **Address** dropdown box and select the VISA resource name. Click **Connect** to connect the instrument, input the command in the **Command** text box and click **Write** to write the command into the instrument. If the command is a query command (for example, :FREQ?), you need to first click **Write** to write the command into the instrument and then click **Read**. The return value 1.500 000 000 00GHz (denote that the current frequency of the RF signal generator is 1.5GHz) is displayed in the **Return** text box. Click **Exit** to exit the program.

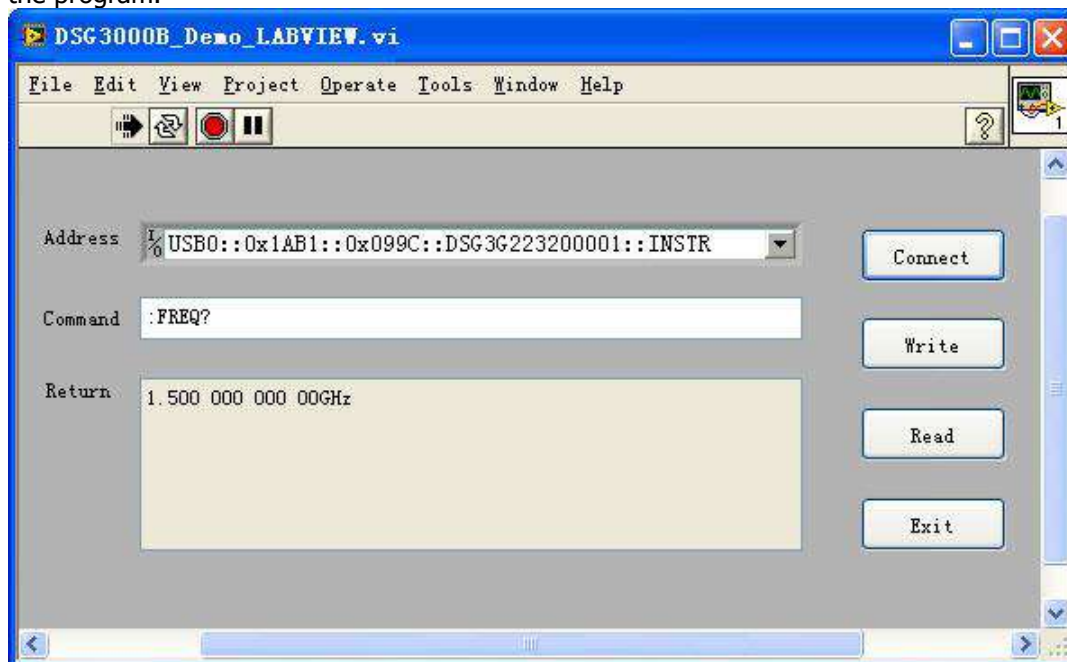

Visual Basic Programming Demo

The program used in this demo: Visual Basic 6.0

The functions realized in this demo: turn on the LF, MOD and RF output switches respectively and use yellow label to indicate that the output is turned on.

1. Build a standard application program project (Standard EXE) and name it as DSG3000B_Demo_VB.
2. Click the **Existing** tab under **Project** → **Add Module**. Find the visa32.bas file under the **include** folder in the installation directory of NI-VISA and add the file.



3. Add three CommandButton controls to represent LF, MOD and RF respectively. Add three Label controls (Label1(0), Label1(1) and Label1(2)) to denote the status of the three switches respectively (the controls are gray by default and are yellow when the output switches are turned on). The layout is as shown in the figure below.

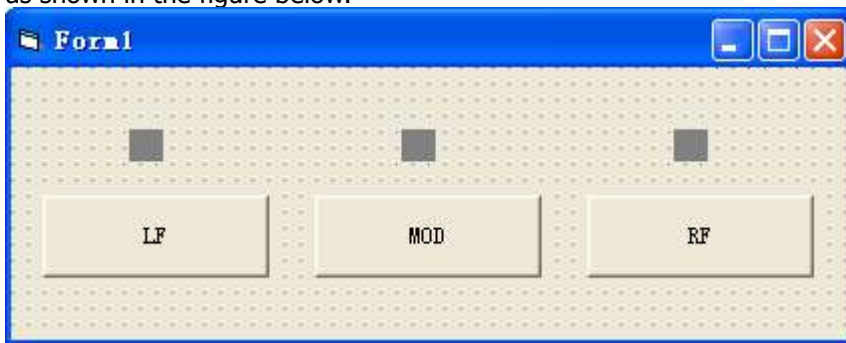

4. Open the **General** tab under **Project** → **Project1 Properties** and select **Form1** from the **Startup Object** dropdown box.
5. Double-click the LF button to enter the programming environment and add the following codes to realize the control of LF, MOD and RF. The codes of LF are as shown below. The codes of MOD and RF are similar.

```
Dim defrm As Long  
Dim vi As Long  
Dim strRes As String * 20
```

```
Dim list As Long
Dim nmatches As Long
Dim matches As String * 200 'Keep the device number acquired
```

```
'Acquire the usb resource of visa
```

```
Call viOpenDefaultRM(defrm)
```

```
Call viFindRsrc(defrm, "USB?* ", list, nmatches, matches)
```

```
'Turn on the device
```

```
Call viOpen(defrm, matches, 0, 0, vi)
```

```
'Send command to query the status of the LF switch
```

```
Call viVPrintf(vi, ":LFO?" + Chr$(10), 0)
```

```
'Acquire the status of LF
```

```
Call viVScanf(vi, "%t", strRes)
```

```
If strRes = 1 Then
```

```
'Send the setting command
```

```
Call viVPrintf(vi, ":LFO OFF" + Chr$(10), 0)
```

```
Label1(0).ForeColor = &H808080 'Gray
```

```
Else
```

```
Call viVPrintf(vi, ":LFO ON" + Chr$(10), 0)
```

```
Label1(0).ForeColor = &HFFFF& 'Yellow
```

```
End If
```

```
'Turn off the resource
```

```
Call viClose(vi)
```

```
Call viClose(defrm)
```

6. Execution Results

- 1) Click "LF" to turn on the LF output. The control above the **LF** button turns yellow (as shown in the figure below). At this point, the RF signal generator can output LF signal via the **[LF OUTPUT]** connector according to the current configuration. Click "LF" again to turn off the LF output and the control above the **LF** button turns gray.

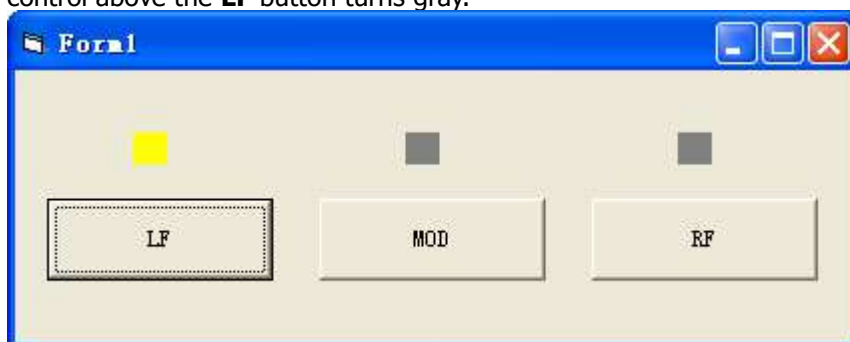

- 2) Click "MOD" to turn on the modulation output and the control above the **MOD** button turns yellow (as shown in the figure below). At this point, the RF signal generator can output the RF modulated signal via the **[RF OUTPUT 50Ω]** connector if the RF output is turned on. Click "MOD" again to turn off the modulation output and the control above the **MOD** button turns gray.

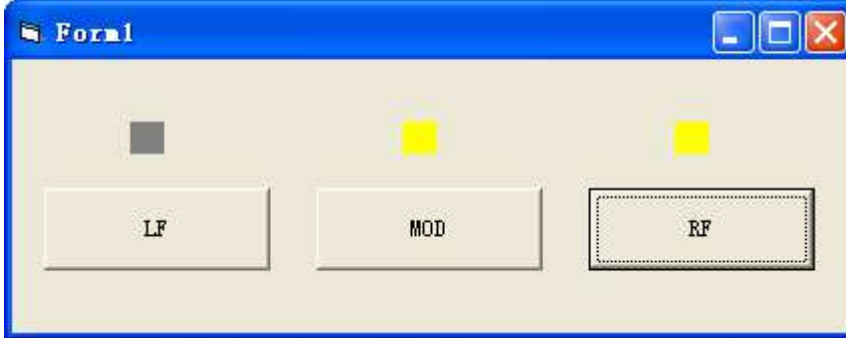

- 3) Click "RF" to turn on the RF output and the control above the **RF** button turns yellow (as shown in the figure below). At this point, the RF signal generator can output RF signal via the **[RF OUTPUT 50Ω]** connector according to the current configuration. Click "RF" again to turn off the RF output and the control above the **RF** button turns gray.

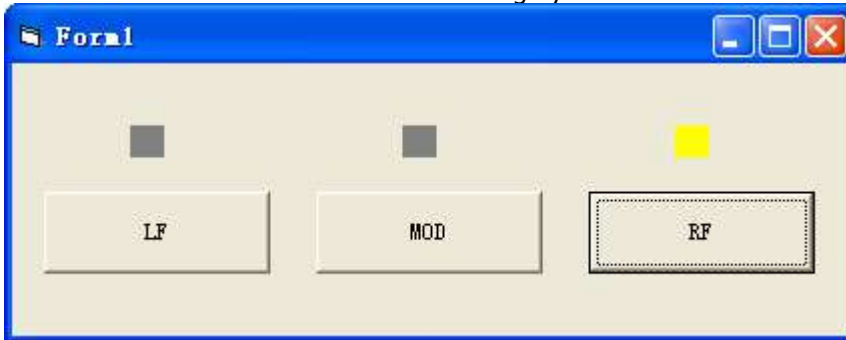

Visual C++ Programming Demo

The program used in this demo: Microsoft Visual C++ 6.0

The functions realized in this demo: search for the instrument address, connect the instrument, send command and read the return value.

1. Run Microsoft Visual C++ 6.0. Create a new MFC project based on dialog box and name it as DSG3000B_DEMO_VC.
2. Click **Project** → **Settings** and add **visa32.lib** under the **Link** tab in the pop-up interface manually.

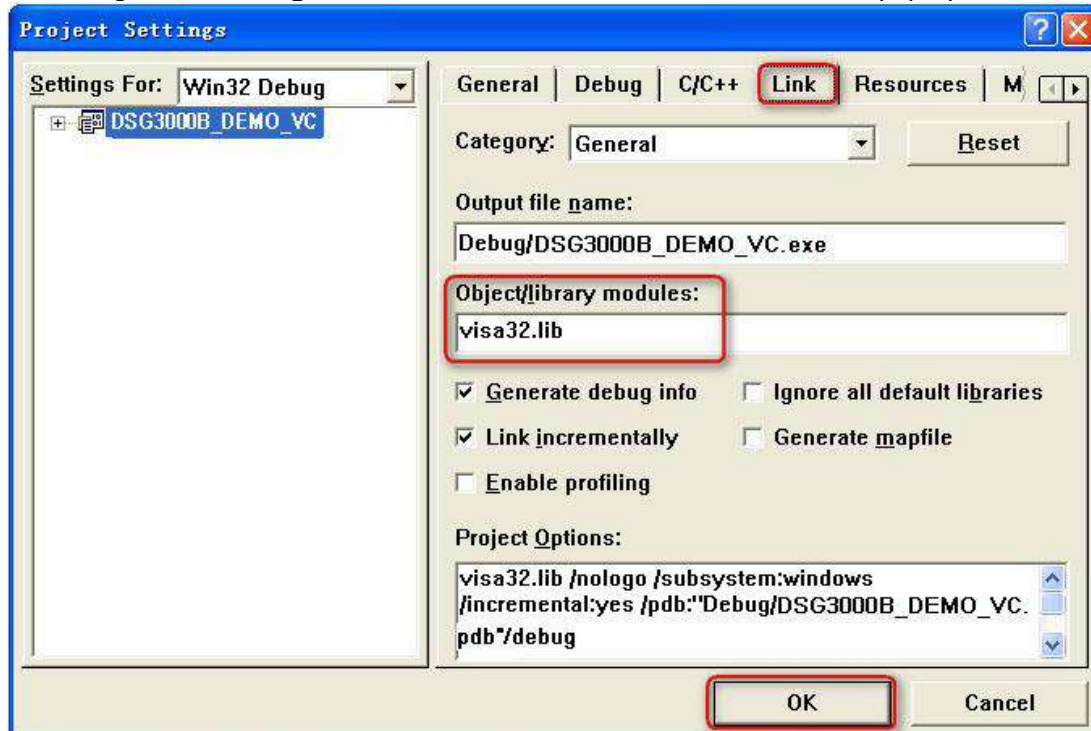

3. Click **Tools** → **Options** and add the **Include** and **Lib** directories under the **Directories** tab in the pop-up interface.

Select **Include files** in **Show directories for** and double-click at the blank in **Directories** to add the path of **Include**: C:\Program Files\IVI Foundation\VISA\WinNT\include.

Select **Library files** in **Show directories for** and double-click at the blank in **Directories** to add the path of **Lib**: C:\Program Files\IVI Foundation\VISA\WinNT\lib\msc.

Note:

The two directories are related to the installation directory of NI-VISA on your PC. Here, NI-VISA is installed under C:\Program Files\IVI Foundation\VISA by default.

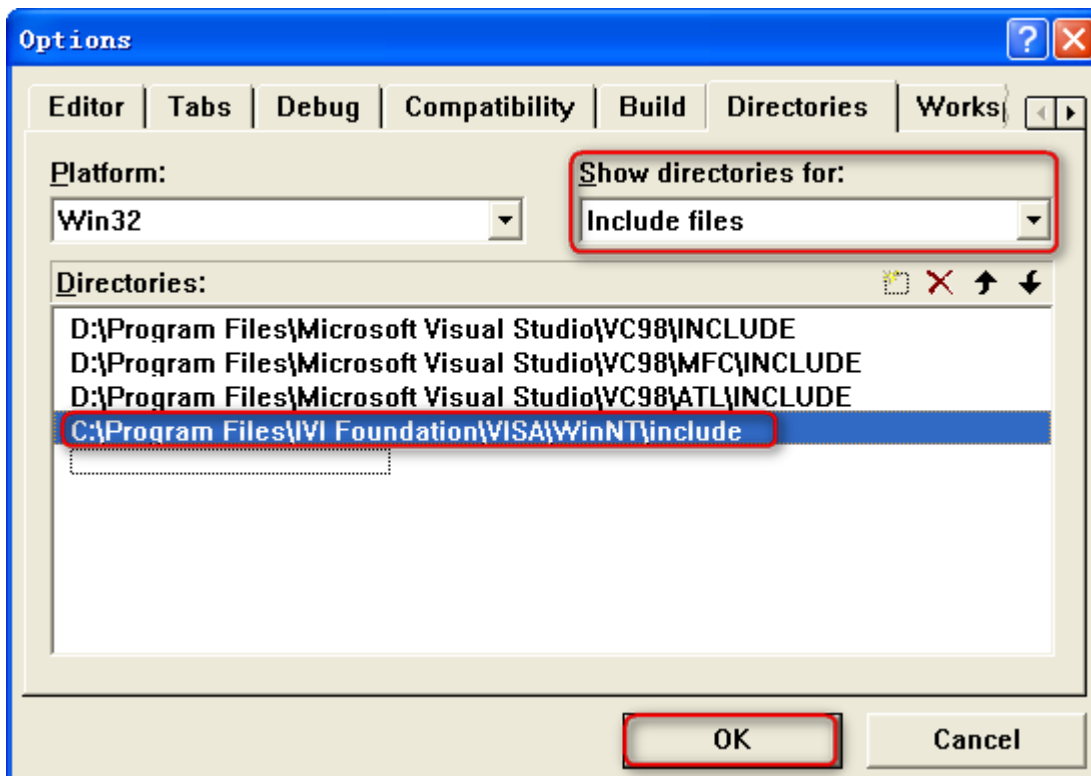

4. Add the **Text**, **Edit** and **Button** controls. The layout is as shown in the figure below.

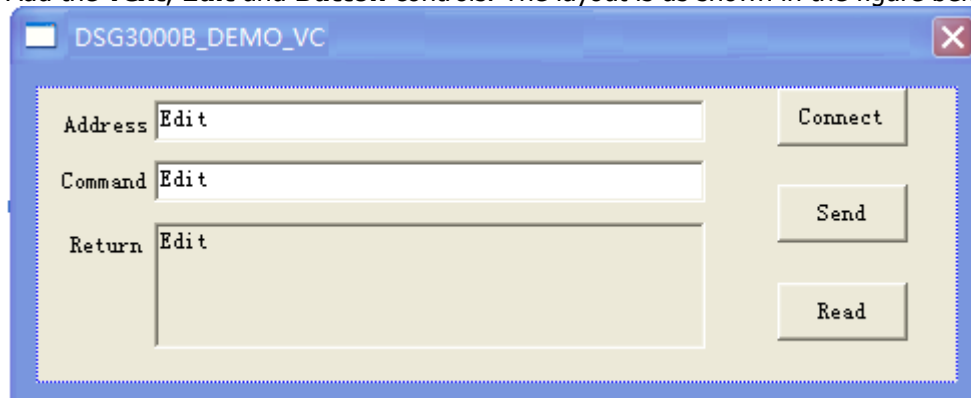

5. Click **View** → **ClassWizard** and add the control variables under the **Member Variables** tab in the pop-up interface.
- Instrument Address: CString m_strInstrAddr
 - Command: CString m_strCommand
 - Return Value: CString m_strResult

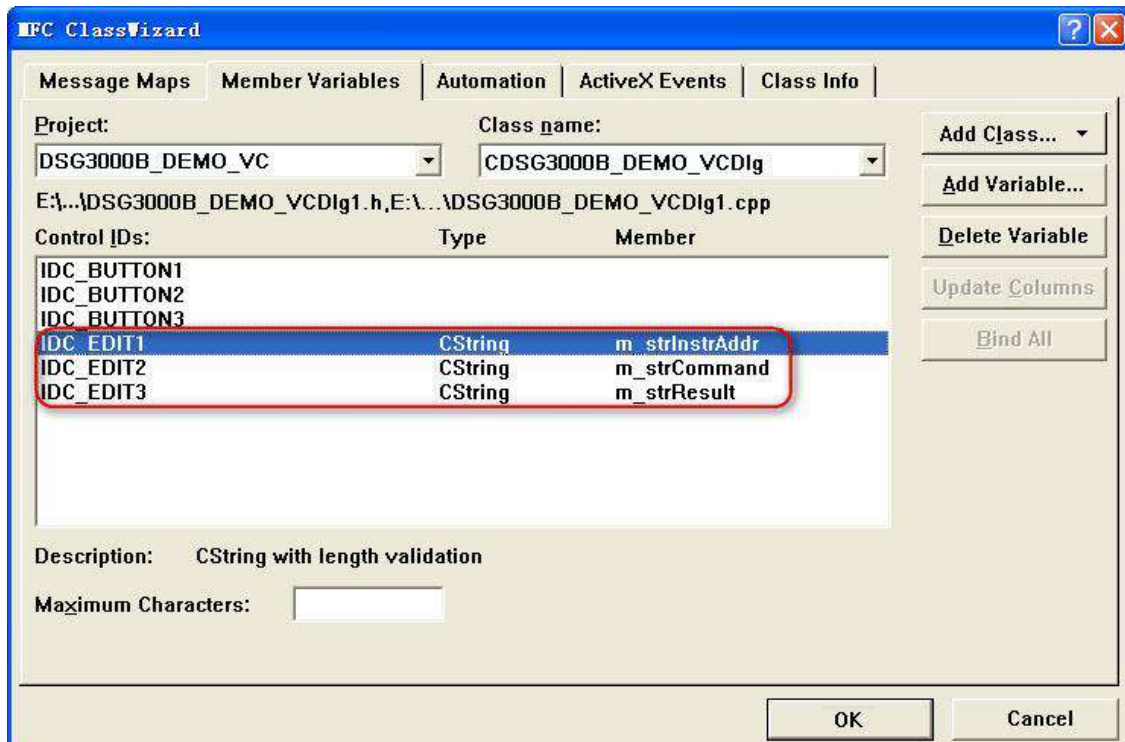

6. Encapsulate the read and write operations of VISA.

1) Encapsulate the write operation of VISA for easier operation.

```
bool CDSG3000B_DEMO_VCDlg::InstrWrite(CString strAddr, CString strContent) //write function
{
```

```
    ViSession defaultRM,instr;
    ViStatus status;
    ViUInt32 retCount;
    char * SendBuf = NULL;
    char * SendAddr = NULL;
    bool bWriteOK = false;
    CString str;
```

```
    //Change the address's data style from CString to char*
```

```
    SendAddr = strAddr.GetBuffer(strAddr.GetLength());
    strcpy(SendAddr,strAddr);
    strAddr.ReleaseBuffer();
```

```
    //Change the command's data style from CString to char*
```

```
    SendBuf = strContent.GetBuffer(strContent.GetLength());
    strcpy(SendBuf,strContent);
    strContent.ReleaseBuffer();
```

```
    //Open the VISA instrument
```

```
    status = viOpenDefaultRM(&defaultRM);
    if (status < VI_SUCCESS)
    {
        AfxMessageBox("No VISA instrument was opened !");
        return false;
    }
```

```
    status = viOpen(defaultRM, SendAddr, VI_NULL, VI_NULL, &instr);
```

```
    //Write command to the instrument
```

```
    status = viWrite(instr, (unsigned char *)SendBuf, strlen(SendBuf), &retCount);
```

```

    //Close the instrument
    status = viClose(instr);
    status = viClose(defaultRM);

    return bWriteOK;
}

```

- 2) Encapsulate the read operation of VISA for easier operation.

```
bool CDSG3000B_DEMO_VCDlg::InstrRead(CString strAddr, CString *pstrResult)
```

```
//Read from the instrument
```

```
{
    ViSession defaultRM,instr;
    ViStatus status;
    ViUInt32 retCount;
    char * SendAddr = NULL;
    unsigned char RecBuf[MAX_REC_SIZE];
    bool bReadOK = false;
    CString str;

    //Change the address's data style from CString to char*
    SendAddr = strAddr.GetBuffer(strAddr.GetLength());
    strcpy(SendAddr,strAddr);
    strAddr.ReleaseBuffer();

    memset(RecBuf,0,MAX_REC_SIZE);

    //Open the VISA instrument
    status = viOpenDefaultRM(&defaultRM);
    if (status < VI_SUCCESS)
    {
        //Error Initializing VISA...exiting
        AfxMessageBox("No VISA instrument was opened !");
        return false;
    }

    //Open the instrument
    status = viOpen(defaultRM, SendAddr, VI_NULL, VI_NULL, &instr);

    //Read from the instrument
    status = viRead(instr, RecBuf, MAX_REC_SIZE, &retCount);

    //Close the instrument
    status = viClose(instr);
    status = viClose(defaultRM);

    (*pstrResult).Format("%s",RecBuf);

    return bReadOK;
}

```

7. Add the control message response codes.

- 1) Connect the instrument

```
void CDSG3000B_DEMO_VCDlg::OnConnect()
```

```
{
    //TODO: Add your control notification handler code here
    ViStatus status;
    ViSession defaultRM;
    ViString expr = "?*";

```



```

ViPFindList findList = new unsigned long;
ViPUInt32 retcnt = new unsigned long;
ViChar instrDesc[1000];
CString strSrc = "";
CString strInstr = "";
unsigned long i = 0;
bool bFindDSG = false;

status = viOpenDefaultRM(&defaultRM);
if (status < VI_SUCCESS)
{
    //Error Initializing VISA...exiting
    MessageBox("No VISA instrument was opened ! ");
    return ;
}

memset(instrDesc,0,1000);

//Find resource
status = viFindRsrc(defaultRM,expr,findList, retcnt, instrDesc);

for (i = 0;i < (*retcnt);i++)
{
    //Get instrument name
    strSrc.Format("%s",instrDesc);
    InstrWrite(strSrc,"*IDN?");
    ::Sleep(200);
    InstrRead(strSrc,&strInstr);

    //If the instrument(resource) belongs to the DSG series then jump out from the loop
    strInstr.MakeUpper();
    if (strInstr.Find("DSG") >= 0)
    {
        bFindDSG = true;
        m_strInstrAddr = strSrc;
        break;
    }

    //Find next instrument
    status = viFindNext(*findList,instrDesc);
}

if (bFindDSG == false)
{
    MessageBox("Didn't find any DSG!");
}
UpdateData(false);
}

2) Write operation
void CDSG3000B_DEMO_VCDlg::OnSend()
{
    //TODO: Add your control notification handler code here
    UpdateData(true);
    if (m_strInstrAddr.IsEmpty())
    {
        MessageBox("Please connect to the instrument first!");
    }
}

```

```
InstrWrite(m_strInstrAddr,m_strCommand);
m_strResult.Empty();
UpdateData(false);
}

3) Read operation
void CDSG3000B_DEMO_VCDlg::OnRead()
{
    //TODO: Add your control notification handler code here
    UpdateData(true);
    InstrRead(m_strInstrAddr,&m_strResult);
    UpdateData(false);
}
```

8. Execution Results

- 1) Click "Connect" to find and connect the RF signal generator. If the instrument is successfully connected, the corresponding USB VISA descriptor will be displayed in the address bar.
- 2) Input command in the "Command" edit box; for example, :SWE:DIR?.
- 3) Click "Send" to send the command.
- 4) Click "Read" to read the return value.

The execution results are as shown in the figure below.



Chapter 5 Appendix

Appendix A: Factory Setting

Parameter	Factory Setting	
FREQ		
	DSG3136B/DSG3136B-IQ	DSG3065B/DSG3065B-IQ
Frequency	13.6GHz	6.5GHz
Frequency Offset	0Hz	
Phase Offset	0deg	
LEVEL		
Amplitude	-110dBm	
Amplitude Limit	20dBm	
Amplitude Offset	0dB	
Level Unit	dBm	
SWEEP		
Sweep	Off	
Sweep Type	Step	
Sweep Mode	Cont	
Start Frequency of Step Sweep	1GHz	
Stop Frequency of Step Sweep	2GHz	
Start Level of Step Sweep	-10dBm	
Stop Level of Step Sweep	-20dBm	
Sweep Points	11	
Dwell Time	500ms	
Sweep Spacing	Lin	
Sweep Shape	Triangle	
Trigger Mode of the Sweep Period	Auto	
Trigger Mode of Each Sweep Point	Auto	
External Trigger Slope	Pos	
Sweep Direction	Fwd	
AM		
Switch	Off	
Modulation Source	Int	
Modulation Depth	50%	
Modulation Frequency	10kHz	
Modulation Waveform	Sine	
Equal Level	Off	
FM/ΦM		
Modulation Type	ΦM	
FM		
Switch	Off	
Modulation Source	Int	
Frequency Deviation	10kHz	
Modulation Rate	10kHz	
Modulation Waveform	Sine	
ΦM		
Switch	Off	
Modulation Source	Int	
Phase Offset	2.5rad	
Modulation Rate	10kHz	
Modulation Waveform	Sine	
Pulse Mod.		
Switch	Off	

Modulation Source	Int
Pulse Mode	Single
Period	1ms
Pulse Width	500us
Trigger Mode	Auto
Pulse Output	Off
Trigger Delay	100us
Modulation Polarity	Normal
External Gated Polarity	Normal
External Trigger Slope	Pos
IQ Mod. (only available for DSG3065B-IQ and DSG3136B-IQ)	
Switch	Off
Source	Int
Baseband Switch	Off
Baseband Level	1 V
Sample Rate	1 MHz
Trigger Mode	Auto
Operation Mode	Retrig
Duration	1
External Delay	0
External Inhibit	0
LF	
Output Waveform	Sine
Output Level	500 mV
Output Frequency	1 kHz
Output Level of Square	500 mV
Output Frequency of Square	1 kHz
Output Control	
RF Switch	Off
MOD Switch	Off
LF Switch	Off
System^[1]	
Language	English
Power-on Setting	Preset
Preset Type	Factory
Remote Interface	Off
DHCP	On
Auto IP	On
Manual IP	Off
GPIB Address	7
Screen Switch	On
Brightness	3
Power Status	Open
Storage^[1]	
File Type	All
Input Method	Number
Prefix State	Off

Note^[1]: Not affected by the preset setting.

Appendix B: Warranty

RIGOL TECHNOLOGIES CO., LTD. (hereinafter referred to as **RIGOL**) warrants that the product will be free from defects in materials and workmanship within the warranty period. If a product proves defective within the warranty period, **RIGOL** guarantees free replacement or repair for the defective product.

To get repair service, please contact with your nearest **RIGOL** sales or service office.

There is no other warranty, expressed or implied, except such as is expressly set forth herein or other applicable warranty card. There is no implied warranty of merchantability or fitness for a particular purpose. Under no circumstances shall **RIGOL** be liable for any consequential, indirect, ensuing, or special damages for any breach of warranty in any case.