

RIGOL

User's Guide

DM3068 Digital Multimeter

Feb. 2014

RIGOL Technologies, Inc.

Guaranty and Declaration

Copyright

© 2010 RIGOL Technologies, Inc. All Rights Reserved.

Trademark Information

RIGOL is a registered trademark of RIGOL Technologies, Inc.

Publication Number

UGC06105-1110

Notices

- **RIGOL** products are protected by patent law in and outside of P.R.C.
- **RIGOL** reserves the right to modify or change parts of or all the specifications and pricing policies at company's sole decision.
- Information in this publication replaces all previously corresponding material.
- **RIGOL** shall not be liable for losses caused by either incidental or consequential in connection with the furnishing, use or performance of this manual as well as any information contained.
- Any part of this document is forbidden to copy or photocopy or rearrange without prior written approval of **RIGOL**.

Product Certification

RIGOL guarantees this product conforms to the national and industrial standards in China as well as the ISO9001:2008 standard and the ISO14001:2004 standard. Other international standard conformance certification is in progress.

Contact Us

If you have any problem or requirement when using our products or this manual, please contact RIGOL Technologies, Inc.

E-mail: service@rigol.com

Website: www.rigol.com

Safety Requirement

General Safety Summary

Please review the following safety precautions carefully before putting the instrument into operation so as to avoid any personal injuries or damages to the instrument and any product connected to it. To prevent potential hazards, please use the instrument only specified by this manual.

Use Proper Power Cord.

Only the power cord designed for the instrument and authorized by local country could be used.

Ground The Instrument.

The instrument is grounded through the Protective Earth lead of the power cord. To avoid electric shock, it is essential to connect the earth terminal of power cord to the Protective Earth terminal before any inputs or outputs.

Observe All Terminal Ratings.

To avoid fire or shock hazard, observe all ratings and markers on the instrument and check your manual for more information about ratings before connecting.

Use Proper Overvoltage Protection.

Make sure that no overvoltage (such as that caused by a thunderstorm) can reach the product, or else the operator might expose to danger of electrical shock.

Do Not Operate Without Covers.

Do not operate the instrument with covers or panels removed.

Use Proper Fuse.

Please use the specified fuses.

Avoid Circuit or Wire Exposure.

Do not touch exposed junctions and components when the unit is powered.

Do Not Operate With Suspected Failures.

If you suspect damage occurs to the instrument, have it inspected by qualified service personnel before further operations. Any maintenance, adjustment or replacement especially to circuits or accessories must be performed by **RIGOL** authorized personnel.

Keep Well Ventilation.

Inadequate ventilation may cause increasing of temperature or damages to the device. So please keep well ventilated and inspect the intake and fan regularly.

Do Not Operate in Wet Conditions.

In order to avoid short circuiting to the interior of the device or electric shock, please do not operate in a humid environment.

Do Not Operate in an Explosive Atmosphere.

In order to avoid damages to the device or personal injuries, it is important to operate the device away from an explosive atmosphere.

Keep Product Surfaces Clean and Dry.

To avoid the influence of dust and/or moisture in air, please keep the surface of device clean and dry.

Electrostatic Prevention.

Operate in an electrostatic discharge protective area environment to avoid damages induced by static discharges. Always ground both the internal and external conductors of the cable to release static before connecting.

Handling Safety.

Please handle with care during transportation to avoid damages to keys, knob and interfaces as well as other parts on the panels.

The disturbance tests of all models conform to the P/F values of A based on the standard of EN 61326: 1997+A1+A2+A3 instead of P/F values of B.

Input Terminal Protection Limit.

The protection limit applies to input terminals:

1. Main input (HI and LO) terminals.

HI and **LO** terminals are used for Voltage, Resistance, Capacitance, Continuity, Frequency and Diodes measurements and should be used under the following two conditions:

- 1) **HI-LO** protection limit: at most 1000 VDC or 750 VAC, this is also the maximum measurable voltage. The limit can be expressed as 1000 Vpk.
- 2) **LO-ground** protection limit: at most 500 Vpk (relative) is allowed to float at **LO** terminal with safety.

Since the HI terminal holds a maximum protection of 1000 Vpk relative to the ground, the sum of the "float" and measured voltages cannot exceed 1000 Vpk.

2. Sampling (HI Sense and LO Sense/200 mA) terminals.

HI Sense and **LO Sense/200 mA** terminals are used for 4-Wire Resistance measurement and should be used under the following two conditions:

- 1) **HI Sense-LO Sense/200 mA** protection limit: 200 Vpk.
- 2) **LO Sense/200 mA-LO** protection limits: 0.5 Vpk. The current input fuse on the rear panel provides the current passing through **LO Sense/200 mA** up to 500 mA protection.

3. Current input (10 A and Sense/200 mA) terminals.

10 A and **LO** terminals are used for current measurements of 2 A and 10 A. The maximum current which goes through the **10 A** terminal is limited to 10 A by the internal fuse. **LO Sense/200 mA** and **LO** terminals are used for current measurements ranging from 200 μ A to 200 mA. The maximum current which go through the **LO Sense/200 mA** terminal is limited to 500 mA by the internal fuse.

Note:

In order to prevent the fuse from blowing out and protect the multimeter, please use the current input terminals according to the following requirements:

- 1) Do not connect the **10 A** and **LO Sense/200 mA** input terminals into the current measuring circuit at the same time.

- 2) Only use **10 A** and **LO** terminals for measurements when the measured current AC+DC RMS value goes within 200 mA and 10 A.
- 3) Select a proper current input terminal according to the estimated current magnitude before connect the multimeter to AC supplies if you want to use current measurement.
- 4) The current into **10 A** cannot exceed 13.5 A, otherwise it will blow out the internal fuse; while the current into the **LO Sense/200 mA** terminal cannot exceed 650 mA, otherwise the current fuse from the rear panel may be blown out.

IEC II Overvoltage Protection.

In order to prevent electric shock, DM3068 provides overvoltage protection for line-voltage mains connections meeting both of the following conditions:

1. The HI and LO input terminals are connected to the mains under Measurement Category II conditions, defined below.
2. The mains are limited to a maximum line voltage of 300 VAC.

Warning: IEC II includes electrical devices connected to mains at an outlet on a branch circuit. Such devices include most small appliances, test equipments and other devices that inserted into a branch socket.

DM3068 may be used to make measurements with the HI and LO inputs connected to mains in such devices (up to 300 VAC), or to the branch socket itself. However, DM3068 may be used with its HI and LO inputs connected to mains from neither permanently installed electrical device such as a main circuit-breaker panel, sub-panel disconnected box nor wired motors. Such devices and circuits are readily to beyond the protection from DM3068.

Note: voltages above 300 VAC may be measured only in circuits that are isolated from mains. However, a transient overvoltage is also present in such circuits. DM3068 was designed to safely withstand occasional transient overvoltage up to 2500 Vpk. Do not use this device to measure circuits whose transient overvoltage may exceed this level.

Safety Terms and Symbols

Terms in this Manual. These terms may appear in this manual:



WARNING

Warning statements indicate the conditions or practices that could result in injury or loss of life.



CAUTION

Caution statements indicate the conditions or practices that could result in damage to this product or other property.



CAT I (1000V)

IEC Measurement Category I. The maximum voltage can be measured by HI-LO terminal is 1000 Vpk.



CAT II (300V)

IEC Measurement Category II. Inputs may be connected to mains (up to 300 VAC) in the case of overvoltage in Category II.

Terms on the Product. These terms may appear on the product:

DANGER indicates an injury or hazard may immediately happen.

WARNING indicates an injury or hazard may be accessible potentially.

CAUTION indicates a potential damage to the instrument or other property might occur.

Symbols on the Product. These symbols may appear on the product:



**Hazardous
Voltage**



**Safety
Warning**



**Protective
Earth
Terminal**



**Chassis
Ground**



**Test
Ground**

General Care and Cleaning

General Care:

Do not store or leave the instrument in where the instrument will be exposed to direct sunlight for long periods of time.

Cleaning:

Clean the instrument regularly according to its operating conditions. To clean the exterior surface, perform the following steps:

1. Disconnect the instrument from all power sources.
2. Clean the loose dust on the outside of the instrument with a lint- free cloth (with a mild detergent and water). When clean the LCD, take care to avoid scarifying it.



CAUTION

To avoid damages to the instrument, do not expose them to liquids which are corrosive.



WARNING

To avoid injury resulting from short circuit, make sure the instrument is completely dry before reconnecting into a power source.

Environmental Considerations

The following symbol indicates that this product complies with the applicable European Union requirements according to Directives 2002/96/EC on waste electrical and electronic equipment (WEEE) and batteries.



Product End-of-Life Handling

The equipment may contain substances that could be harmful to the environment or human health. In order to avoid release of such substances into the environment and harm to human health, we encourage you to recycle this product in an appropriate system that will ensure that most of the materials are reused or recycled appropriately. Please contact your local authorities for disposal or recycling information.

DM3068 Overview

DM3068 is a 6½ digits, dual display digital multimeter. It is a perfect combination of basic measurement functions, various math operations as well as any sensor measurement and can fulfill users' requirements for high precision, various functions and auto measurement.

DM3068 provides high-resolution 256 x 64 monochrome LCD, easy-to-use keypad layout and key backlight as well as operation prompts. It supports RS232, USB, LAN and GPIB interfaces, USB storage device storage and remote control (web and SCPI command).

Main Features:

- Real 6½ digits reading resolution.
- Minimum integration time: 0.006 PLC.
- Dual display: synchronously display two kinds of characteristics of the same signal.
- Switch between "Normal" and "Preset" operation modes. The "Preset" mode can quickly recall the preset configurations.
- DC voltage measurement range: -1050 V to 1050 V.
- DC current measurement range: -10.5 A to 10.5 A.
- AC voltage measurement range: True-RMS, 0 V to 787.5 V.
- AC current measurement range: True-RMS, 0 A to 10.5 A.
- Resistance measurement range: 0 Ω to 110 M Ω; support 2-wire (2WR) and 4-wire (4WR) resistance measurements.
- Capacitance measurement range: 0 F to 110 mF.
- Frequency measurement range: 3 Hz to 1 MHz.
- Continuity and Diode tests.
- User-defined any sensor measurements and three types of temperature sensor measurements: TC, RTD and THERM.
- Plenty of math operations such as STA (MAX, MIN, AVG, ALL), P/F, dBm, dB, REL as well as real-time tendency graph and histogram display functions.
- Enable to store data and configuration in USB storage device.
- Plenty of interfaces: USB Device, USB Host, GPIB, RS232 and LAN.
- Support the command sets of RIGOL DM3068, Agilent 34401A (including some extensions) and Fluke 45.

- Two power management modes: enable or disable the front panel power switch.
- Enable to store 10 groups of system configurations and 5 groups of sensor configurations in internal memory and recall them when necessary.
- Configuration clone: back up all the instrument configurations in a USB storage device or clone the configurations to other DM3068.
- Provide English/Chinese menus and built-in help system.
- Powerful remote control and any sensor editing software.

Document Overview

Chapter 1 Quick Start

This chapter guides users to quickly get familiar with the front and rear panels, user interface and measurement connections of the multimeter.

Chapter 2 Front-panel Operations

This chapter introduces how to use the functions of the multimeter from the front panel.

Chapter 3 Remote Control

This chapter introduces how to control the multimeter remotely.

Chapter 4 Troubleshooting

This chapter lists the failures that might occur when using the multimeter as well as their solutions.

Chapter 5 Measurement Tutorial

This chapter introduces how to eliminate the possible errors during the measurement and obtain accurate measurement result.

Chapter 6 Specifications

This chapter lists the specifications and characteristics of the multimeter.

Chapter 7 Appendix

This chapter provides the accessories information as well as the service information of the multimeter.

Format Conventions in this Manual:

- **Button:**

The function keys at the front panel of the multimeter are expressed by the key icons. For example,  denotes the DC voltage measurement function key.

- **Menu:**

The operation menu at the bottom of the screen is expressed by "Menu Word+Character Shading". For example, the menu "REL" is expressed as "REL".

- **Operation step:**

"→" is used to indicate operation steps. For example, "⏮ → REL" means pressing ⏮ and then pressing REL.

Contents

Guaranty and Declaration	I
Safety Requirement	II
General Safety Summary	II
Safety Terms and Symbols	VI
General Care and Cleaning	VII
Environmental Considerations	VIII
DM3068 Overview	IX
Document Overview	XI
Chapter 1 Quick Start	1-1
General Inspection	1-2
Handle Adjustment	1-3
Appearance and Dimensions	1-4
Front Panel	1-5
Rear Panel	1-9
User Interface	1-13
To Use the Multimeter for the First Time	1-14
Measurement Connections	1-15
To Use the Built-in Help System	1-18
To Use the Rack Mount Kit	1-19
Kit Parts List	1-19
Installation Tool	1-20
Installation Space	1-20
Installation Procedures	1-22
Chapter 2 Front Panel Operations	2-1
To Set the Range.....	2-2
To Set the Resolution.....	2-3
Basic Measurement Functions.....	2-5
To Measure DC Voltage.....	2-5
To Measure AC Voltage.....	2-7
To Measure DC Current	2-9
To Measure AC Current.....	2-11

To Measure Resistance	2-14
To Measure Capacitance	2-17
To Measure Continuity	2-19
To Measure Diode	2-21
To Measure Frequency and Period	2-23
Any Sensor Measurement	2-26
User-defined Sensor	2-28
Temperature sensor	2-33
Preset Mode	2-37
Secondary Function Key	2-38
Measurement Configuration	2-40
Integration Time	2-41
DC Impedance	2-42
Auto Zero	2-43
Offset Compensation	2-44
AC Filter	2-45
Short-Circuit Resistance	2-46
Current Source	2-47
Gate Time	2-48
Math Operations	2-49
Math	2-50
Tendency Graph	2-57
Histogram	2-59
Trigger	2-60
To Select a Trigger Source	2-61
Reading Hold	2-62
To Set the Trigger Parameters	2-63
Trigger Output	2-64
Save and Recall	2-65
Storage Type	2-66
Internal Storage	2-67
External Storage	2-67
To Save a File	2-68
Utility	2-69
Command Set	2-69
Interface Configurations	2-70
System Configuration	2-77

To Perform the Self-Test.....	2-81
Chapter 3 Remote Control	3-1
Web Control.....	3-2
Command Control	3-5
Remote Control via USB.....	3-6
Remote Control via LAN.....	3-8
Remote Control via GPIB	3-11
Remote Control via RS232	3-13
Chapter 4 Troubleshooting	4-1
Chapter 5 Measurement Tutorial	5-1
Loading Errors (DCV)	5-2
True-RMS AC Measurements.....	5-3
Crest Factor Errors (non-sinusoidal inputs).....	5-5
Loading Errors (ACV)	5-6
Chapter 6 Specifications	6-1
DC Characteristics	6-1
AC Characteristics.....	6-6
Frequency and Period Characteristics	6-11
Capacitance Characteristics	6-13
Temperature Characteristics	6-14
Measurement Rate	6-16
Other Measuring Characteristics.....	6-18
General Specifications.....	6-20
Chapter 7 Appendix	7-1
Appendix A: DM3068 Accessories.....	7-1
Appendix B: Warranty	7-2
Index	1

Chapter 1 Quick Start

This chapter guides users to quickly get familiar with the front and rear panels, user interface and measurement connections of the multimeter.

This chapter contains the following topics:

- General Inspection
- Handle Adjustment
- Appearance and Dimensions
- Front Panel
- Rear Panel
- User Interface
- First-use of the Multimeter
- Measurement Connections
- To Use the Built-in Help System
- To Use the Rack Mount Kit

General Inspection

1. Inspect the shipping container for damage

Keep the damaged shipping container or cushioning material until the contents of the shipment have been checked for completeness and the instrument has passed both electrical and mechanical tests.

The consigner or carrier shall be liable for the damage to the instrument resulting from shipment. **RIGOL** would not be responsible for free maintenance/rework or replacement of the unit.

2. Inspect the instrument

In case of any damage, or defect, or failure, notify your **RIGOL** sales representative.

3. Check the accessories

Please check the accessories according to the packing lists. If the accessories are incomplete or damaged, please contact your **RIGOL** sales representative.

Handle Adjustment

To adjust the handle position of the multimeter, grip the handle by both sides and pull outward, then rotate the handle to a desired position, see figure below.

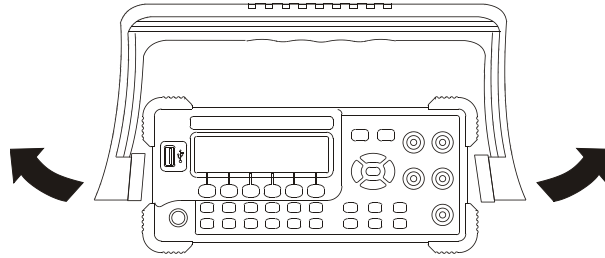

Figure 1-1 Handle Adjustment

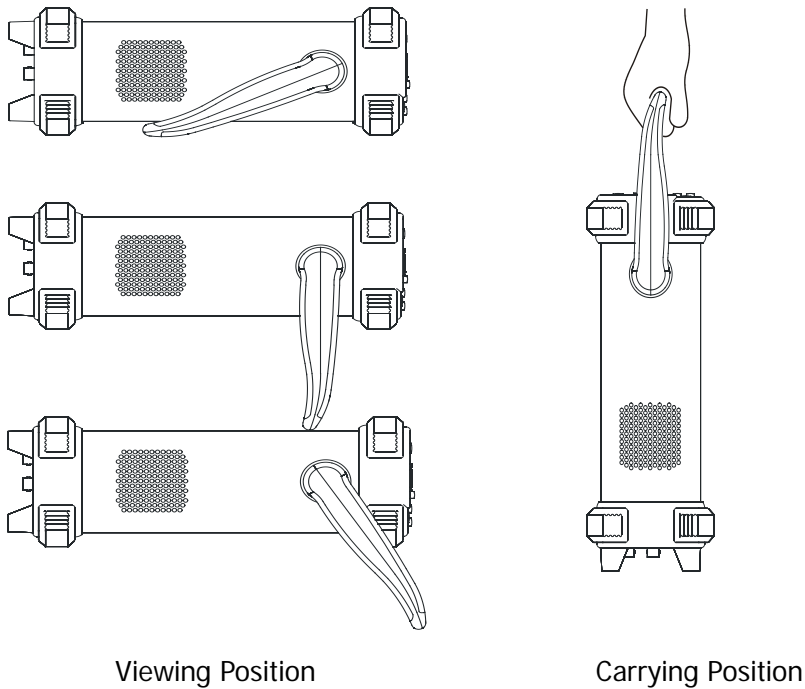

Figure 1-2 Place the Multimeter

Appearance and Dimensions

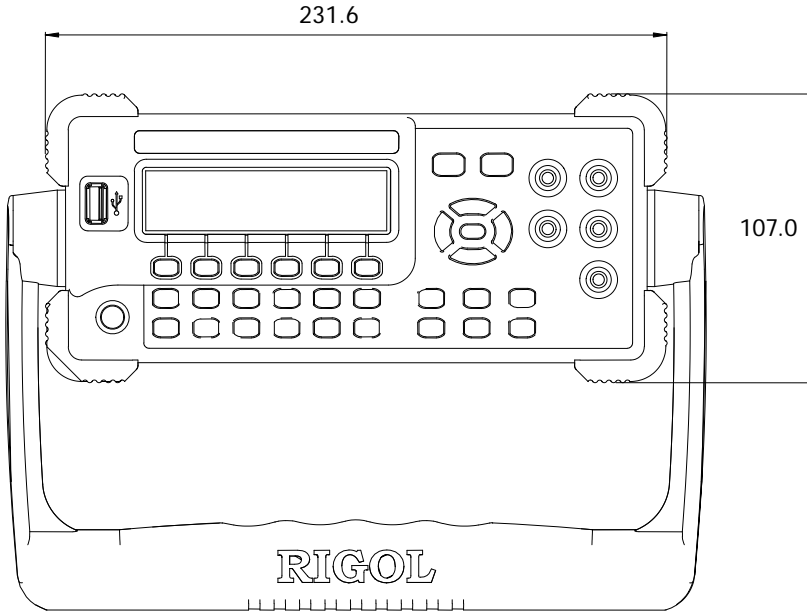

Figure 1-3 Front View

Unit: mm

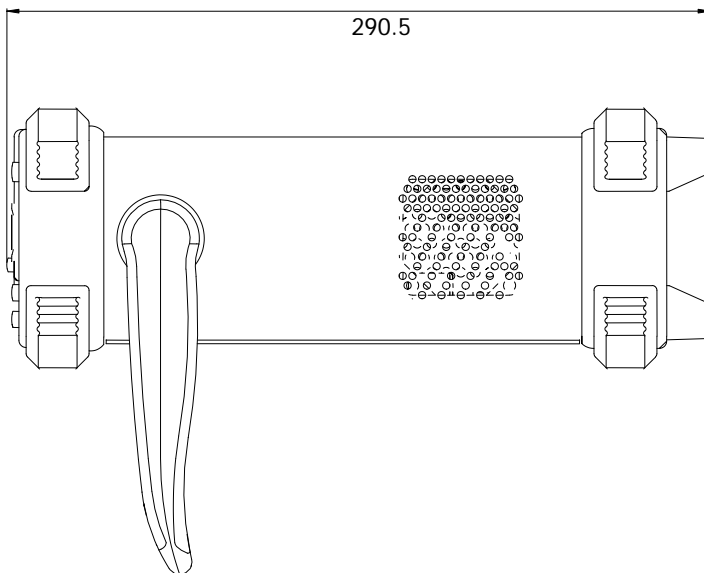

Figure 1-4 Side view

Unit: mm

Front Panel

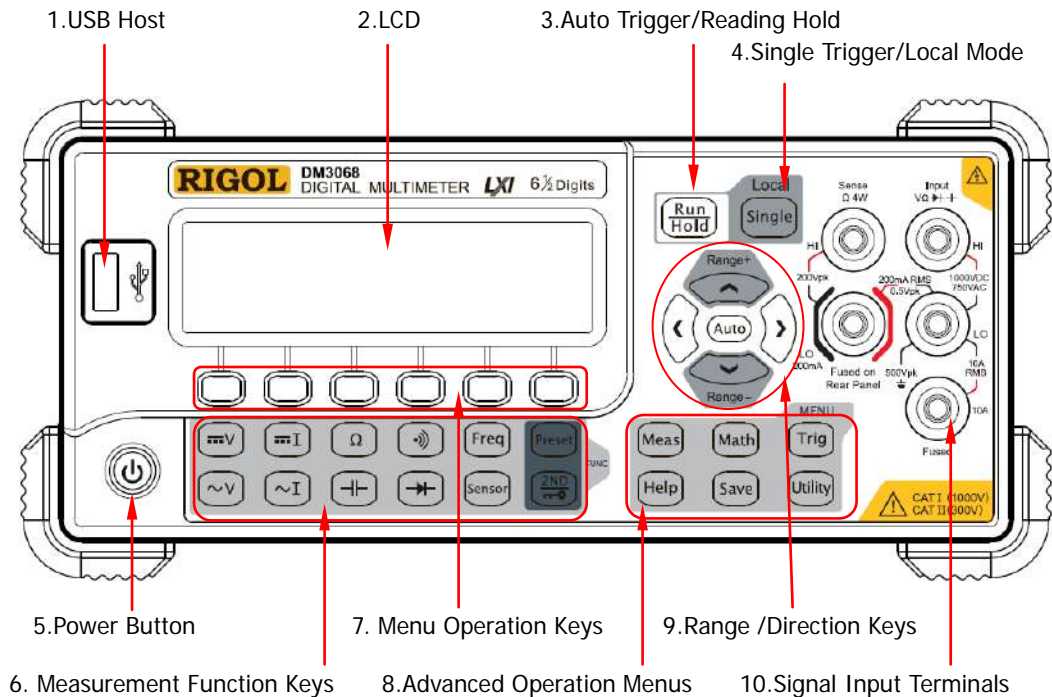

Figure 1-5 Front Panel Overview

1. USB Host

USB storage device can be connected via this interface. By using this interface, the system configuration or measurement data can be stored into USB storage device and be recalled when required.

2. LCD

The instrument provides a 256 x 64 monochrome LCD that can display the current function menus, measurement parameter settings, system status, prompt messages and so on.

3. Auto Trigger/Reading Hold

Continuously pressing this key can switch between auto trigger and reading hold functions.

- Auto Trigger: the backlight is always on; the multimeter continuously takes readings at the fastest rate possible for the present configuration.

- Reading Hold: the backlight blinks; the multimeter obtains a stable reading and displays it on the screen.

4. Single Trigger/Local Mode

When the multimeter is in local mode, press this key to select single trigger; the multimeter generates one or the specified number (**S No.**) of readings and then waits for the next trigger. When the instrument is in remote mode, press this key to switch to local mode.











5. Power Button

Press the button to turn on or off the multimeter. Users can enable or disable this key as required.



Press  → **System** → **Cfg** → **Switch** and select "ON" or "OFF".

6. Measurement Function Keys

Basic Measurement Function Keys

-  DC Voltage Measurement (DCV)
-  AC Voltage Measurement (ACV)
-  DC Current Measurement (DCI)
-  AC Current Measurement (ACI)
-  Resistance Measurement (OHM)
-  Capacitance Measurement (CAP)
-  Continuity Test (CONT)
-  Diode Test (DIODE)
-  Frequency/Period Measurements (FREQ/PERIOD)
-  Any Sensor Measurements (SENSOR), such as DCV, DCI, 2WR, 4WR, FREQ, TC (thermoelectric couple), RTD (resistance temperature detectors) and THERM (thermistor).

Common Function Keys

-  Quickly save or recall 10 groups of instrument settings.
-  Secondary Function key
 - Enable the dual display function.
 - Quickly save the current instrument configuration when used in conjunction with .
 - Quickly enter the setting interface of relative measurement (REL).

7. Menu Operation Keys

Press any softkey to activate the corresponding menu.

8. Advanced Operation Menus



Set all the measurement parameters.



Perform math operations (statistic, P/F, dBm, dB, REL) on the measurement results and provide real-time tendency graph and histogram display.



Provide auto, single, external and level trigger; enable to set the reading hold function, number of samples per trigger, delay time before reading and edge of the trigger input signal as well as the trigger output parameter.



Save the system configuration and measurement data into internal memory or external USB storage device and recall or delete them when required.



Select command set for the multimeter; configure the interface parameters and system parameters; execute self-test and view the system information and error messages.



Provide help information for common operations and the use method of the built-in help. The multimeter allows users to quickly recall the help information about any front panel keys and menu softkeys.

9. Range/Direction Keys



Enable auto range.



- Configure the measurement parameters.
- Select the cursor position while entering a parameter.



- Increase or decrease the measurement range.
- Enter desired numeric value while setting a parameter.
- Page up or down.

10. Signal Input Terminals

The measured signal (device) will be connected into the multimeter through these terminals. Different measurement objects have different connection methods. For details, please refer to "**Measurement Connections**".

Rear Panel

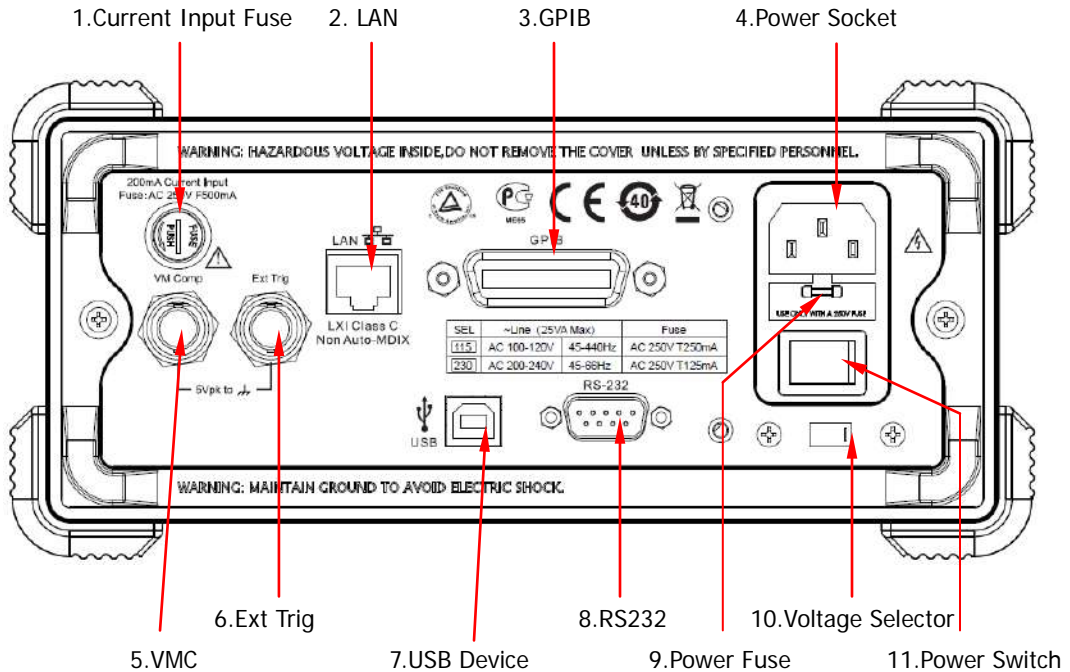

Figure 1-6 Rear Panel Overview

1. Current Input Fuse

The multimeter uses two kinds of fuses for input protections of small and large current ranges. The internal fuse of the multimeter provides **10 A** maximum input protection for the large current range and when the input current exceeds 13.5 A, the fuse will blow out; while the current input fuse at the rear panel of the instrument provides 500 mA maximum input protection for the small current range and when the input current exceeds 650 mA, the fuse will blow out. The large current input fuse has been installed when the instrument left factory. To replace the small current fuse, please:

- 1) Turn off the multimeter and remove the power cord.
- 2) Turn the fuse seat counterclockwise as shown in the figure using a straight screw driver and then pull out the fuse seat.

200mA Current Input
Fuse: AC 250V F500mA

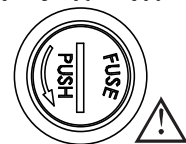

- 3) Place a new specified fuse.
- 4) Reinstall the fuse seat into the slot.

Note: the large current fuse stands inside the multimeter and is not allowed to be replaced by users themselves. If a new fuse is required, please contact **RIGOL**.

2. LAN

Through this interface, the multimeter can be connected to the network for remote control. The multimeter conforms to LXI-C standards; it can be used in connection with other standard devices to quickly build a testing system and easily realize LAN based system integration.

3. GPIB

Conform to IEEE-488.2 standards.

4. Power Socket

The multimeter accepts two types of AC supplies. Please use the power cord provided in the accessories to connect the multimeter to the AC power through this socket.

Note: a proper voltage scale must be first selected (through the **Voltage Selector**) before power connection.

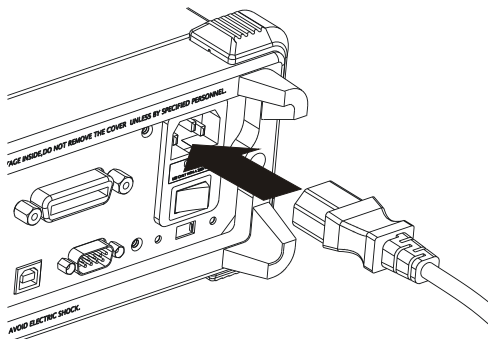

Figure 1-7 Connect the Power Cord

5. VMC

The multimeter outputs a low-trig pulse from the **[VM Comp]** connector after every measurement when VM output is enabled (Trig → VMC → ON).

6. Ext Trig

Trigger the multimeter by connecting a trigger pulse through the [Ext Trig] connector. Note the external trigger source must be selected (Trig → Source → Ext).

7. USB Device

Connect the PC through this interface. You can use SCPI commands or PC software to control DM3068 remotely.

8. RS232

Connect the PC through this interface. You can use SCPI commands or PC software to control DM3068 remotely. You can also use this interface to output the P/F test result.

9. Power Fuse

The multimeter is already installed with a power fuse before leaving factory. To replace a new one, please:

- 1) Turn off the multimeter and remove the power cord.
- 2) Press down the block tongue using a straight screwdriver (in the direction of the dotted arrow in the figure below) and pull out of the fuse seat.
- 3) Select a proper voltage scale.
- 4) Replace a specified fuse.
- 5) Reinstall the fuse seat into the slot.

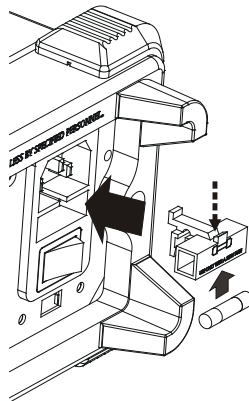

Figure 1-8 Replace the Power Fuse

**WARNING**

In order to avoid electric shock or fire, please just use the specified fuse and make sure the fuse holder is not short-circuited.

10. Voltage Selector

Select a proper voltage scale (115 V or 230 V) according to the AC supply used.

11. Power Switch

Connect or disconnect the AC supply. If the power button at the front panel is disabled (Utility) → System → Cfg → Switch → OFF), turning on this switch will directly start up the multimeter.

User Interface

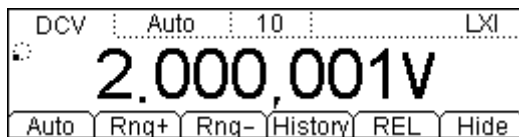

Figure 1-9 User Interface (Single Display)

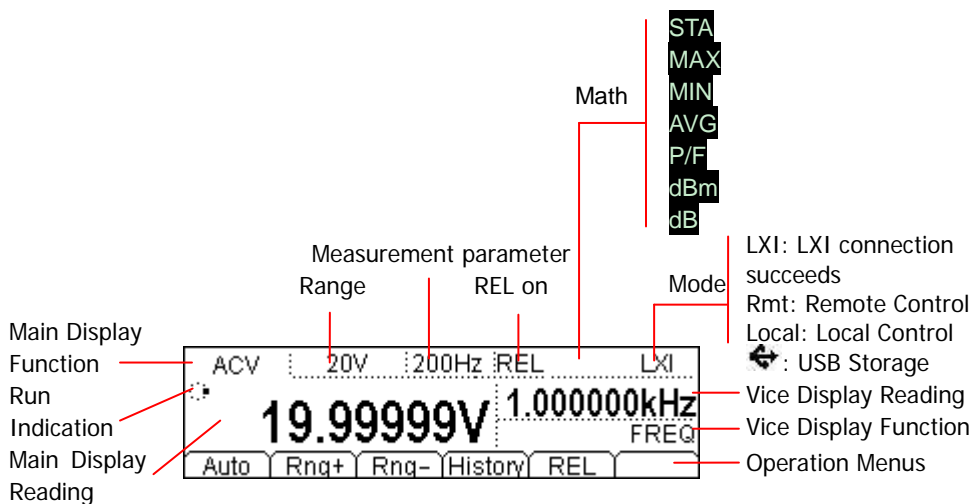

Figure 1-10 User Interface (Dual Display)

To Use the Multimeter for the First Time

Start your multimeter according to the following steps when using it for the first time.

1. Connect the AC Power Supply

- 1) Select an appropriate voltage scale according to the present AC power using the voltage selector at the rear panel.
- 2) Connect the multimeter to the AC power supply using the power cord provided in the accessories.

2. Turn On the Multimeter

Turn on the power switch under the power socket and the power button at the front panel. Note that the multimeter will directly start after you turning on the rear power switch if the front power button is disabled (Utility → System → Cfg → Switch → OFF).

3. Start-up Process

- 1) Normal start: the multimeter executes self-test and then enters the user interface.
- 2) Start with a USB storage device containing update file inserted: the multimeter directly updates if an update file is detected and then starts.

4. If the multimeter does not starts normally, please:

- 1) Make sure the power cord is in good connection.
- 2) Make sure the rear power switch is turned on.
- 3) Try to restart the multimeter, if it fails, check the power fuse and replace a new one when necessary.
- 4) If the problem still remains, please contact **RIGOL**.

Measurement Connections

DM3068 is designed with many measurement functions. After selecting the desired measurement function, please connect the signal (device) under test to the multimeter according to the method below. Do not discretionarily switch the measurement function when measuring as it may cause damage to the multimeter. For example, when the test leads are connected to the related current terminals, AC voltage measurement should not be taken.

DCV Measurement

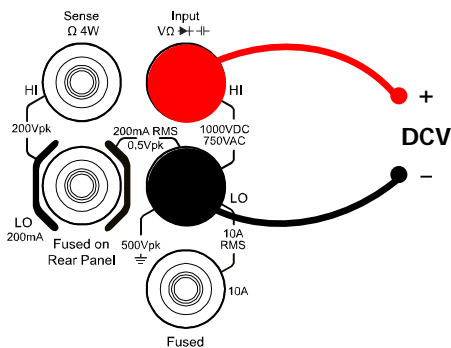

ACV Measurement

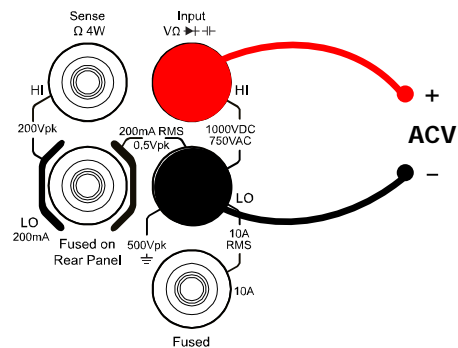

DCI/ACI Measurement (Small Current)

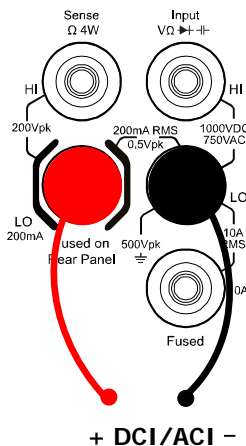

DCI/ACI Measurement (Large Current)

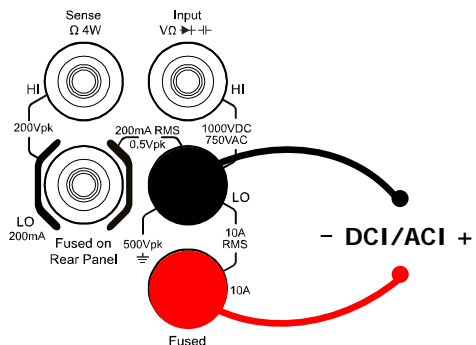

Note: in order to protect the multimeter, please execute DC/AC current measurement following the requirements below.

1. Do not connect the **10 A** and **LO Sense/200 mA** input terminals into the current measuring circuit at the same time.

2. Select a proper current input terminal according to the estimated current magnitude before connecting the multimeter to AC power supply if you want to use current measurement.
3. Only use **10 A** and **LO** terminals for measurements when the AC+DC RMS value of the current under measurement goes within 200 mA and 10 A.

Resistance Measurement (2-wire)

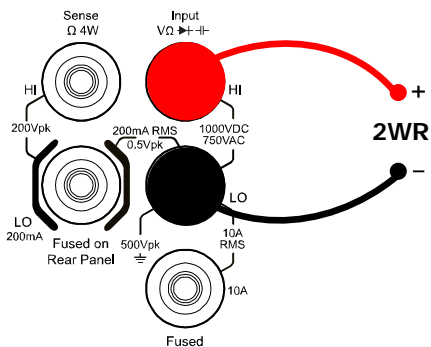

Resistance Measurement (4-wire)

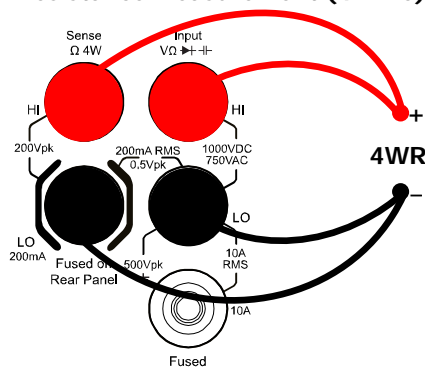

Capacitance Measurement

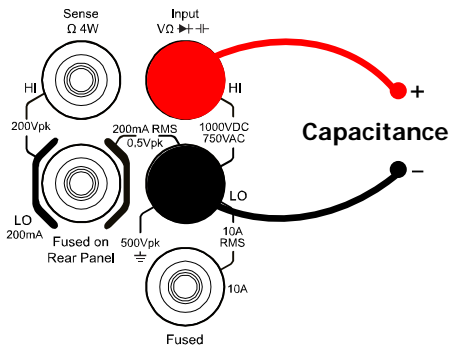

Continuity Measurement

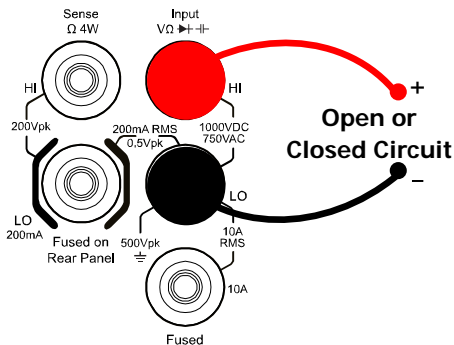

Diode Measurement

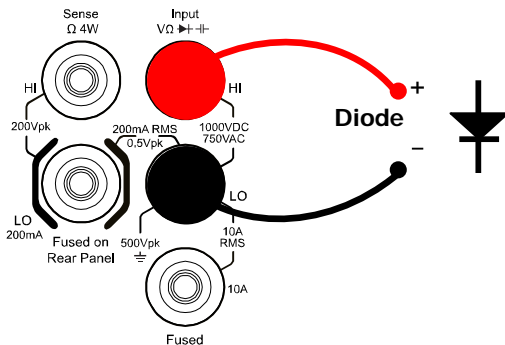

Frequency/Period Measurement

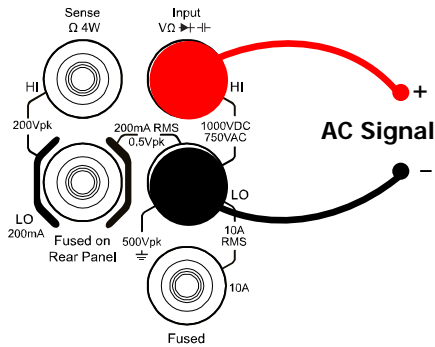

Any Sensor Measurement

(For DCV, 2WR, FREQ, TC, 2W-RTD and 2W-THERM sensors)

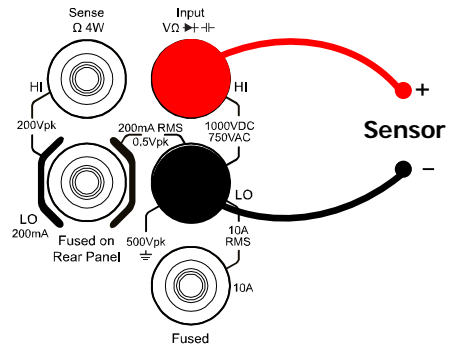

Any Sensor Measurement

(For DCI sensor*)

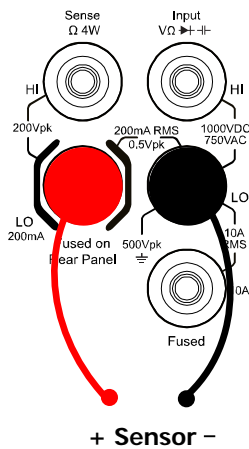

Any Sensor Measurement

(For 4WR, 4W-RTD and 4W-THERM sensors)

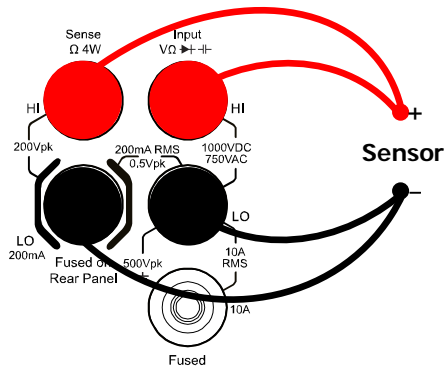

Note*: before setting the parameters for DCI sensor when using it, please connect it according to the figure above and press  → mA.

To Use the Built-in Help System

The built-in help system of DM3068 provides using help for all the front panel keys and menu softkeys as well as the using method of the built-in help. Press  to enter the following interface.

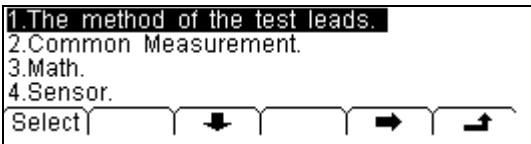







Figure 1-11 Help Topics

Table 1-1 Help Menu

Menu	Description
Select	Go to the selected help topic
	Cursor up
	Cursor down
	Page up
	Page down
	Go to the previous menu

Help Topics

1. The method of the test leads.
2. Common measurement.
3. Math.
4. Sensor.
5. Store and recall.
6. Utility.
7. I/O interface.
8. Online help.
9. To change the power fuse.
10. Support.

To Use the Rack Mount Kit

DM3068 can be mounted into a standard 19-inch rack cabinet. Before the installation, please remove the package and cushioning material of the multimeter.

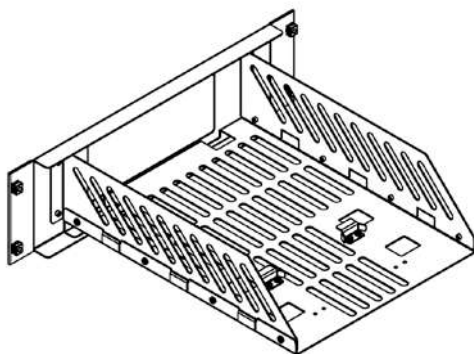

Kit Parts List

Table 1-2 Kit Parts List

No.	Name	Qty	Part Number	Description
1-1	Front Panel	1	RM-DM-3-01	-
1-2	Support Board	1	RM-DM-3-02	-
1-3	Left Plate	1	RM-DM-3-03	-
1-4	Right Plate	1	RM-DM-3-04	-
1-5	Fixed Finger	2	RM-DM-3-05	-
2-1	M4 Screw	16	RM-SCREW-01	M4*8 Phil-Slot Pan Head Machine Screw Nail
2-2	M6 Screw	4	RM-SCREW-02	M6*16 Phil-Slot Pan Head Machine Screw Nail
2-3	M6 Nut	4	RM-SCREW-03	M6*5 Square Machine Female Screw with Lock Blade

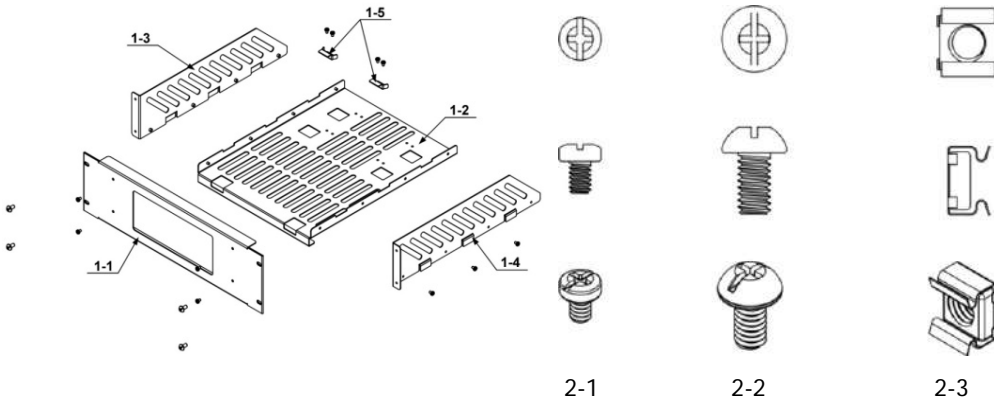

Installation Tool

PH2 cross screwdriver is recommended.

Installation Space

The machine cabinet should fulfill the following requirements:

- The machine cabinet should be a standard 19-inch one.
- At least a 3U space (133.5 mm) should be provided by the machine cabinet.
- The depth inside the machine cabinet should not be less than 400 mm.

Dimensions of the mounted instrument:

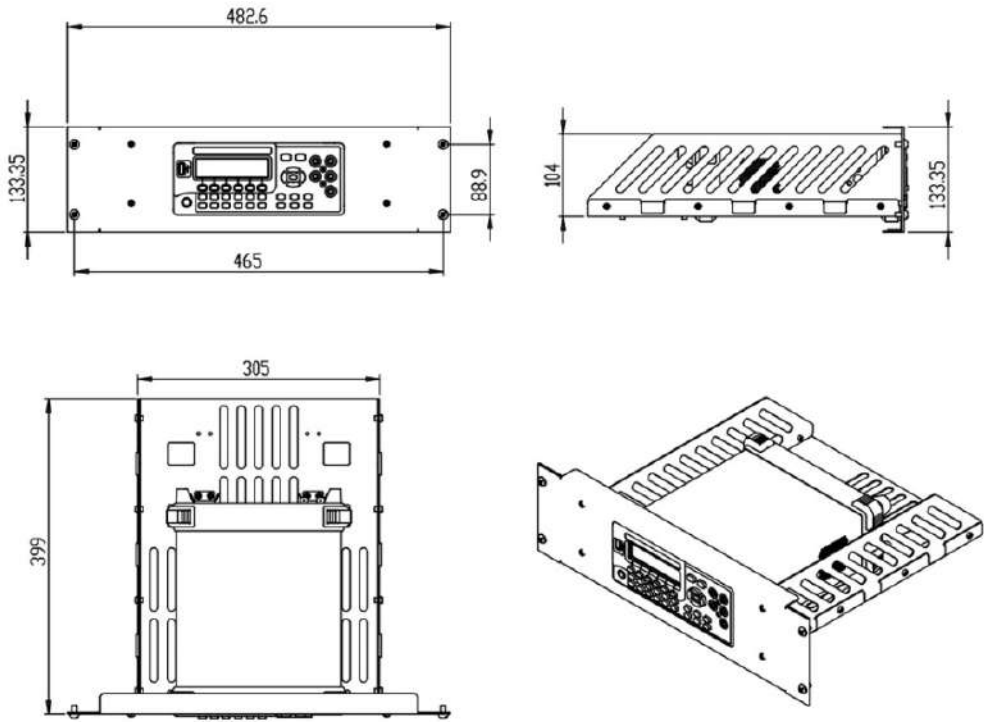

Installation Procedures

This operation should be executed only by authorized personnel. Improper operations may cause instrument damage or incorrect installation of the instrument into the machine cabinet.

1. Remove the handle: grip the handle by both sides and pull outward; then, pull upward.

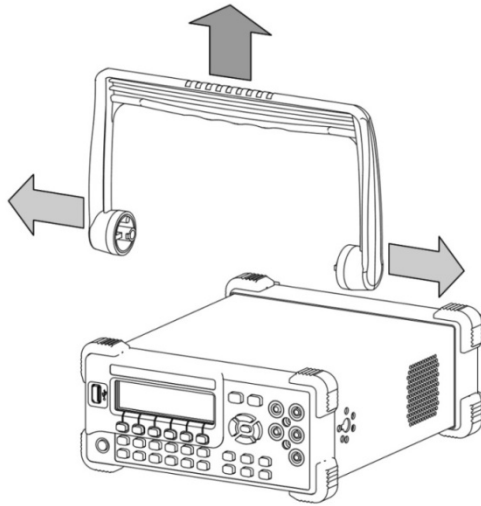

2. Install left and right plates: aim the detents of right and left plates at the openings on support board and insert respectively, then fix them using eight M4 screws.

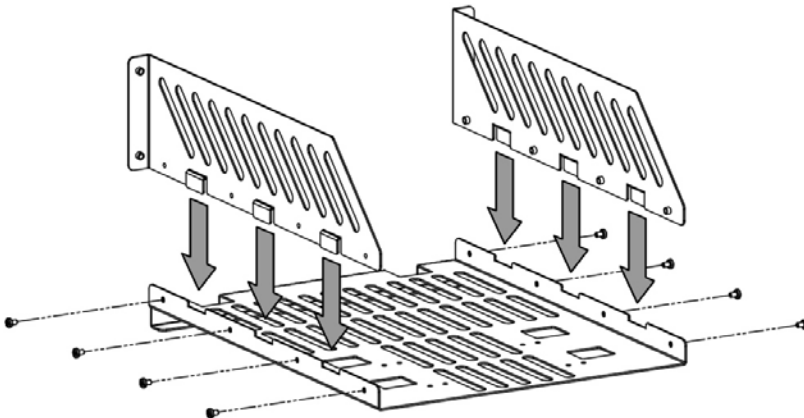

3. Place the instrument: aim the parallels at the corresponding openings and then put the multimeter onto the support board.

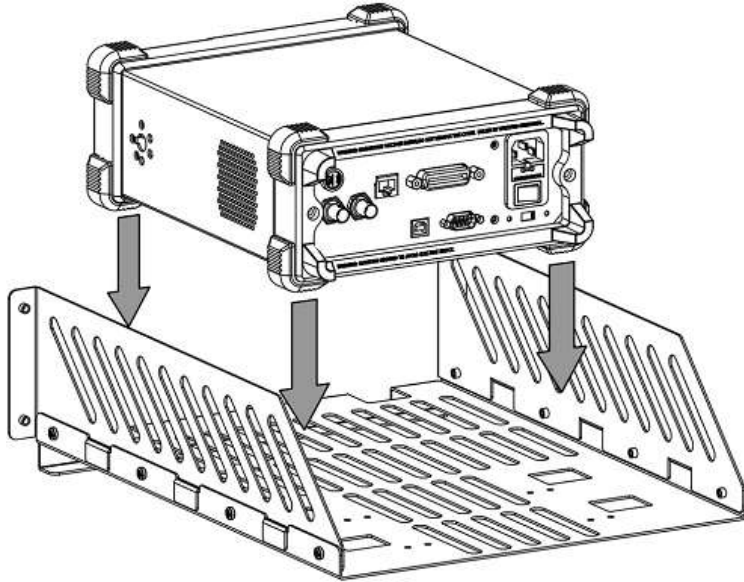

4. Fix the instrument: fasten or fit the instrument tightly into the support board using two fixed fingers in connection with four M4 screws.

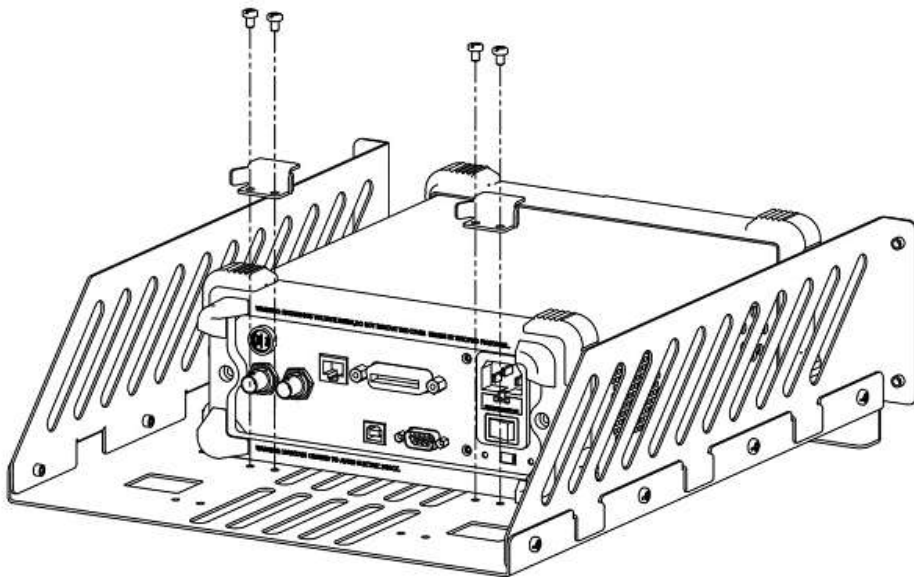

- 5. Mount the front panel: aim the front panel opening at the front of instrument and fix them using four M4 screws.

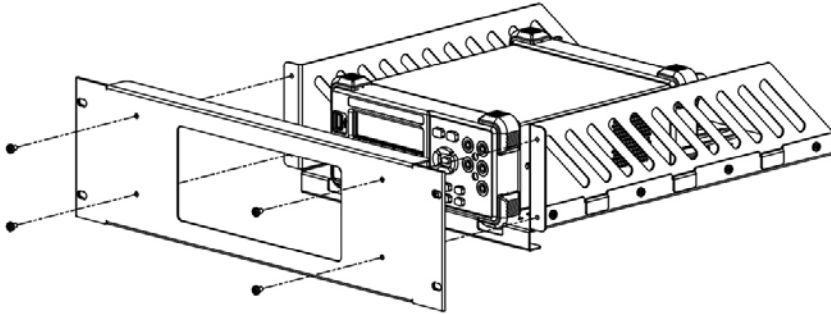

- 6. Load into machine cabinet: mount the rack with instrument onto a standard 19-inch machine cabinet using four M6 screws and four M6 square nuts, respectively.

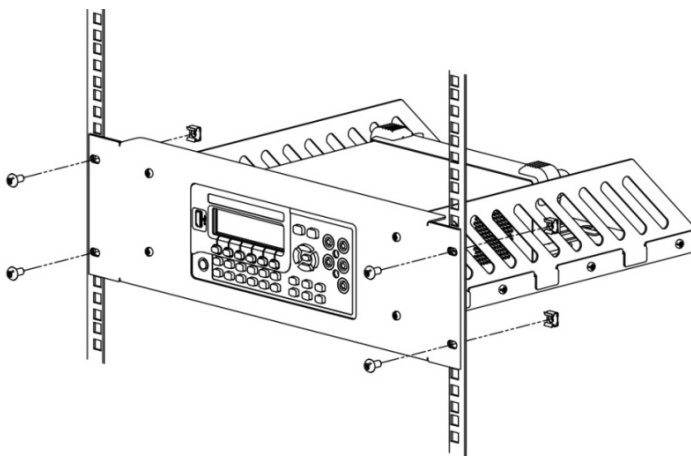

- 7. Post-installation note: the rack holds a height of 3U. Holes pointed out by the arrows are the installation holes and should be aligned with when installing.

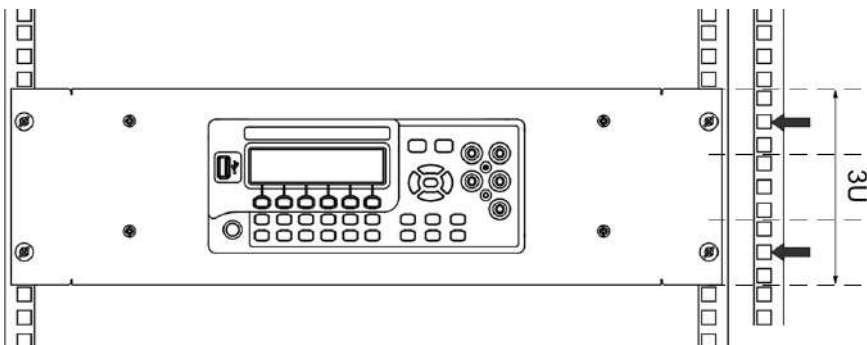

Chapter 2 Front Panel Operations

This chapter introduces how to use the functions of the multimeter from the front panel.

The chapter contains the following topics:

- To Set the Range
- To Set the Resolution
- Basic Measurement Functions
- Any Sensor Measurement
- Preset Mode
- Secondary Function Key
- Measurement Configuration
- Math Operations
- Trigger
- Save and Recall
- Utility

To Set the Range

DM3068 provides auto and manual range selecting modes. In auto mode, the multimeter selects a proper range automatically according to the input signal; in manual mode, you can use the front panel key or menu key to set the range. The auto mode can bring a lot of convenience for users while the manual mode provides higher reading precision.

Method 1: use the front panel key to set the range

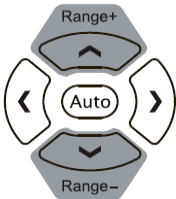

- Auto mode: Press **Auto** to enable the auto range.
- Manual mode: Press **Range+** or **Range-** to increase or reduce the range.

Method 2: use the menu key to select the range

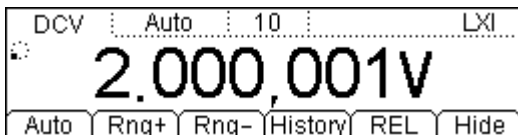

- Auto range: Press **Auto** to directly enable the auto range.
- Manual range: Press **Rng+** or **Rng-** to specify a desired range manually.

Note:

- "OVER LOAD" will be displayed when the input signal exceeds the current range.
- By default, the range is set to Auto at power-on or after a reset.
- Auto mode is recommended if you are not sure about the measurement range in order to protect the instrument and obtain accurate data.
- In FREQ/PERIOD measurements, the multimeter uses different gate times to include all input signals within 3 Hz and 1 MHz.
- The range of CONT measurement is fixed at 2 k Ω ; the range of DIODE measurement is related to the current source currently selected.

To Set the Resolution

DM3068 holds reading resolutions of $3\frac{1}{2}$, $4\frac{1}{2}$, $5\frac{1}{2}$ and $6\frac{1}{2}$ digits. It automatically selects a reading resolution according to the current measurement settings. The greater the resolution is, the higher the measurement accuracy will be; the lower the resolution is, the faster the measurement will be. Different measurement function has different resolution.

1. In DCV, DCI and OHM measurements, press the left and right direction keys at the front panel () to set the reading resolution to $5\frac{1}{2}$ or $6\frac{1}{2}$ digits. The resolution affects the integration time and vice versa.

Table 2-1 Relationship between reading resolution and integration time

Resolution	Integration time	Status bar display
$5\frac{1}{2}$	0.006 PLC	0.006
	0.02 PLC	0.02
	0.06 PLC	0.06
	0.2 PLC	0.2
	1 PLC	1
$6\frac{1}{2}$	2 PLC	2
	10 PLC	10
	100 PLC	100

2. In ACV and ACI measurements, the resolution is fixed at $6\frac{1}{2}$ digits. Press the left and right direction keys to set the filter type.

Table 2-2 Relationship between the frequency and speed of AC filter

Resolution	AC filter	Speed	Status bar display
$6\frac{1}{2}$	200 Hz	Fast	200 Hz
$6\frac{1}{2}$	20 Hz	Mid	20 Hz
$6\frac{1}{2}$	3 Hz	Slow	3 Hz

3. In FREQ and PERIOD measurements, the resolution is fixed at $6\frac{1}{2}$ digits. Press the left and right direction keys to set the gate time.

Table 2-3 Relationship between the resolution and gate time

Resolution	Gate Time	Status bar display
$6^{1/2}$	1 ms	1 ms
$6^{1/2}$	10 ms	10 ms
$6^{1/2}$	100 ms	100 ms
$6^{1/2}$	1 s	1 s

4. The resolution is $3^{1/2}$ in CAP measurement.
5. The instrument always displays three digits after the decimal point in SENSOR measurement.
6. The instrument always displays one digit after the decimal point in CONT measurement.
7. The resolution is $5^{1/2}$ in DIODE measurement.

Basic Measurement Functions

To Measure DC Voltage

Range: 200 mV, 2 V, 20 V, 200 V, 1000 V

Max Resolution: 100 nV (in the range of 200 mV)

Input Protection: a 1000 V protection is available in all ranges and a 10% overrange for all ranges except 1000 V range. If the reading exceeds 1050 V in 1000 V range, "OVER LOAD" will be displayed.

Operating Steps:

1. Enable the DCV measurement

Press  at the front panel to enter the following interface. By default, DCV measurement is selected at each power-on.

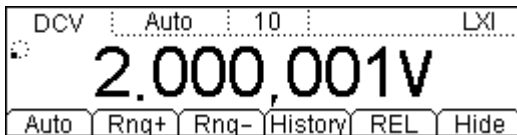

2. Make connection

Connect the test leads with the measured signal by referring to "Measurement Connections".

3. Set the range and resolution

Specify an appropriate range and resolution according to the measured signal and measurement requirements. A high voltage icon "⚡" will appear at the upper left corner of the screen when the 1000 V range is selected.

4. Set the measurement parameters (Optional)

The DCV measurement allows users to configure the integration time, dc impedance and auto zero. For details, please refer to "Measurement Configuration".

5. Read the measurement value

The multimeter measures the input signal according to the current measurement settings and displays the measurement result on the screen.

6. Make math operation (advanced)

You can perform math operation (STA, P/F, dBm, dB and REL) on every DCV measurement reading. For REL operation, the multimeter subtracts the pre-specified value of REL operation from the actual measurement result and displays the result. For details, please refer to “**Math Operations**”.

7. View history data

Up to 5000 latest measured data can be viewed. Press **History** to enter the following interface.

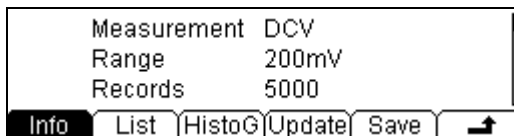

- Press **Info** and use the up and down direction keys to view the measurement item, measurement range, number of values, maximum, minimum, average and standard deviation.
- Press **List** and use the up and down direction keys or the menu softkeys to view all the measurement results before the last update in table form.
- Press **HistoG** to view the histogram of the average (AVG) and standard deviation (SDEV).
- Press **Update** to update the “Records”, “Maximum”, “Minimum”, “Average” and “SDEV” under **Info** and the display in **List** and **HistoG**.
- Press **Save** to enter the store and recall interface; at this point, **Save** is illuminated. You can save the current measurement data into internal memory or external USB storage device. For details, please refer to the introduction in “**Save and Recall**”.

8. Hide the menu

Press **Hide** to hide the operation menus for easier observation of the measurement result. Press any softkey again to display the operation menus.

To Measure AC Voltage

Range: 200 mV, 2 V, 20 V, 200 V, 750 V

Max Resolution: 100 nV (in the range of 200 mV)

Input Protection: a 750 V input protection is available in all ranges and a 10% overrange is available on all ranges except 750 V. If the reading exceeds 787.5 V in 750 V range, "**OVER LOAD**" will be displayed.

Operating Steps:

1. Enable the ACV measurement

Press  at the front panel to enter the following interface.



2. Make connection

Connect the test lead with the measured signal by referring to "**Measurement Connections**".



3. Set the range

Specify an appropriate range (the resolution is fixed at $6^{1/2}$ digits) according to the measured signal and measurement requirements. A high voltage icon "" will be displayed at the upper left corner of the screen when the 750 V range is selected.

4. Set the measurement parameters (Optional)

The ACV measurement allows users to configure the filter. For details, please refer to "**Measurement Configuration**".

5. Read the measurement value

The multimeter measures the input signal according to the current measurement settings and displays the value on the screen. For AC signal, you can also measure the frequency of the signal. During the ACV measurement, press  and then press ; the measurement result is as

shown in the figure below.

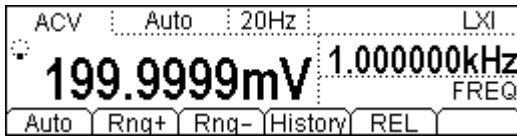

6. Make math operation (advanced)

Users can perform math operation (STA, P/F, dBm, dB and REL) on each ACV measurement reading. For REL operation, the multimeter subtracts the pre-specified value of REL from the actual measurement result and displays the result. For details, please refer to “**Math Operations**”.

7. View history data

Up to 5000 latest measured data can be viewed. Press **History** to enter the following interface.

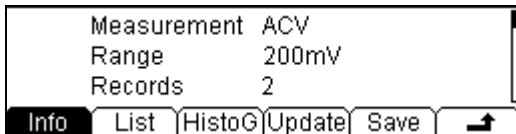

- Press **Info** and use the up and down direction keys to view the measurement item, measurement range, number of values, maximum, minimum, average and standard deviation.
- Press **List** and use the up and down direction keys or the menu softkeys to view all the measurement results before the last update in table form.
- Press **HistoG** to view the histogram of the average (AVG) and standard deviation (SDEV).
- Press **Update** to update the “Records”, “Maximum”, “Minimum”, “Average” and “SDEV” under **Info** and the display in **List** and **HistoG**.
- Press **Save** to enter the store and recall interface; at this point, **Save** is illuminated. You can save the current measurement data into internal memory or external USB storage device. For details, please refer to the introduction in “**Save and Recall**”.

8. Hide the menu

Press **Hide** to hide the operation menus for easier observation of the measurement result. Press any softkey again to display the operation menus.

To Measure DC Current

Range: 200 μ A, 2 mA, 20 mA, 200 mA, 2 A, 10 A

Max Resolution: 0.1 nA (in 200 μ A range)

Input Protection: the multimeter uses two kinds of fuses for current protection: the small current input fuse (500 mA high speed fuse) and the built-in large current input fuse (10 A). 10% overrange is available on all ranges except 10 A. If the reading exceeds 10.5 A in 10 A range, "**OVER LOAD**" will be displayed.

In order to obtain more accurate measurement results, DM3068 deals with small and large input currents separately. The multimeter will use small current measurement mode for current within 200 mA and use large current measurement mode for current that is equal to or higher than 2 A.

Operating Steps:

1. Enable the DCI measurement

Press  at the front panel to enter the following interface.

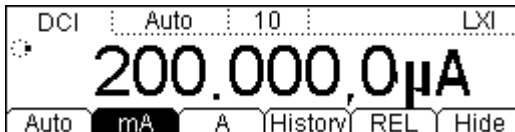

2. Make connection

Connect the test lead with the measured signal by referring to "**Measurement Connections**".

3. Set the range and resolution

Specify an appropriate range and resolution according to the measured signal and measurement requirements. A high voltage icon "" will be displayed at the upper left corner of the screen when the 10 A range is selected.

4. Set the measurement parameters (Optional)

The DCI measurement allows users to configure the integration time and auto zero. For details, please refer to "**Measurement Configuration**".

5. Read the measurement value

The multimeter measures the input signal according to the current measurement settings and displays the value on the screen.

6. Make math operation (advanced)

Users can perform math operation (STA, P/F, and REL) on each DCI measurement reading. For REL operation, the multimeter subtracts the pre-specified value of REL from the actual measurement result and displays the result. For details, please refer to “**Math Operations**”

7. View history data

Up to 5000 latest measured data can be viewed. Press **History** to enter the following interface.

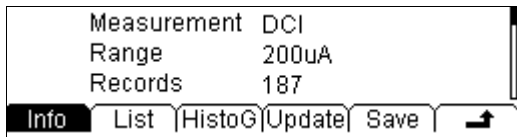

- Press **Info** and use the up and down direction keys to view the measurement item, measurement range, number of values, maximum, minimum, average and standard deviation.
- Press **List** and use the up and down direction keys or the menu softkeys to view all the measurement results before the last update in table form.
- Press **HistoG** to view the histogram of the average (AVG) and standard deviation (SDEV).
- Press **Update** to update the “Records”, “Maximum”, “Minimum”, “Average” and “SDEV” under **Info** and the display in **List** and **HistoG**.
- Press **Save** to enter the store and recall interface; at this point, **Save** is illuminated. You can save the current measurement data into internal memory or external USB storage device. For details, please refer to the introduction in “**Save and Recall**”.

8. Hide the menu

Press **Hide** to hide the operation menus for easier observation of the measurement result. Press any softkey again to display the operation menus.

To Measure AC Current

Range: 200 μ A, 2 mA, 20 mA, 200 mA, 2 A, 10 A

Max Resolution: 0.1 nA (in 200 μ A range)

Input Protection: the multimeter uses two kinds of fuses for input protection: the small current input fuse (500 mA high speed fuse) at the rear panel and the built-in large current input fuse (10 A). 10% overrange is available on all ranges except 10 A. If the reading exceeds 10.5 A in 10 A range, "**OVER LOAD**" will be displayed.

In order to obtain more accurate measurement results, DM3068 deals with small and large input currents separately. The multimeter will use small current measurement mode for current within 200 mA and use large current measurement mode for current that is equal to or higher than 2 A.

Operating Steps:

1. Enable the ACI measurement

Press  at the front panel to enter the following interface.

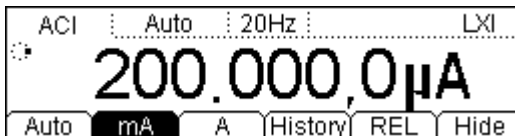

2. Make connection

Connect the test lead with the measured signal by referring to "**Measurement Connections**".



3. Set the range

Specify an appropriate range (the resolution is fixed at $6^{1/2}$ digits) according to the measured signal and measurement requirements. A high voltage icon "⚡" will be displayed at the upper left corner of the screen when the 10 A range is selected.

4. Set the measurement parameters (Optional)

The DCI measurement allows users to configure the filter. For details, please refer to "**Measurement Configuration**".

5. Read the measurement value

The multimeter measures the input signal according to the current measurement settings and displays the value on the screen. For AC signal, users can also measure the frequency/period of the signal. During the ACI measurement, press  and then press  and the measurement result is as shown in the figure on the next page.

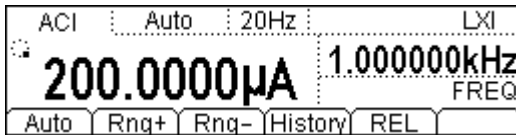



6. Make math operation (advanced)

Users can perform math operation (STA, P/F, and REL) on each ACI measurement reading. For REL operation, the multimeter subtracts the pre-specified value of REL from the actual measurement result and displays the result. For details, please refer to “**Math Operations**”.

7. View history data

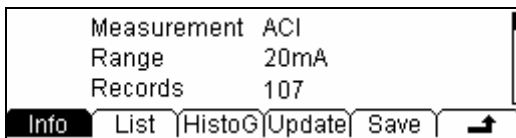
Up to 5000 latest measured data can be viewed. Press **History** to enter the following interface.



- Press **Info** and use the up and down direction keys to view the measurement item, measurement range, number of values, maximum, minimum, average and standard deviation.
- Press **List** and use the up and down direction keys or the menu softkeys to view all the measurement results before the last update in table form.
- Press **HistoG** to view the histogram of the average (AVG) and standard deviation (SDEV).
- Press **Update** to update the “Records”, “Maximum”, “Minimum”, “Average” and “SDEV” under **Info** and the display in **List** and **HistoG**.
- Press **Save** to enter the store and recall interface; at this point,  is illuminated. You can save the current measurement data into internal memory or external USB storage device. For details, please refer to the introduction in “**Save and Recall**”.

8. Hide the menu

Press **Hide** to hide the operation menus for easier observation of the measurement result. Press any softkey again to display the operation menus.

To Measure Resistance

Range: 200 Ω , 2 k Ω , 20 k Ω , 200 k Ω , 1 M Ω , 10 M Ω , 100 M Ω

Max Resolution: 100 $\mu\Omega$ (in 200 Ω range)

Input Protection: a 1000 V input protection is available in all ranges. 10% overrange is available on all ranges.

DM3068 provides 2-wire (2WR) and 4-wire (4WR) resistance measurements. When the measured resistance is lower than 100 k Ω , the 4-wire resistance measurement is recommended to reduce the measurement error caused by test lead resistance and contact resistance between the probe and the testing point because these two resistances cannot be ignored any more, compared to the measured resistance.

Operating Steps:

1. Enable the 2WR/4WR measurement

Press Ω at the front panel to select 2WR (2-wire resistance)/4WR (4-wire resistance) measurement and to enter the following interface.

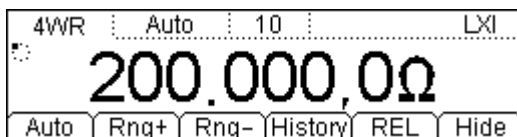
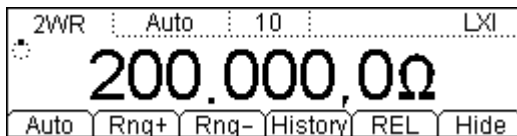

2. Make connection

Connect the test lead with the measured resistance by referring to "Measurement Connections".

3. Set the range and resolution

Specify an appropriate range and resolution according to the measured signal and measurement requirements.

4. Set the measurement parameters (Optional)

The 2WR/4WR measurement allows users to configure the integration time, auto zero and offset compensation. For details, please refer to “**Measurement Configuration**”.

5. Read the measurement value

The multimeter measures the measured resistance according to the current measurement settings and displays the value on the screen.

6. Make math operation (advanced)

Users can perform math operation (STA, P/F, dBm, dB and REL) on each 2WR/4WR measurement reading. For **REL** operation, the multimeter subtracts the pre-specified value of REL from the actual measurement result and displays the result. For details, please refer to “**Math Operations**”.

Tip

- If the measured resistance is small, REL operation is recommended in order to reduce the error caused by test lead.
- Both ends of the measured resistance should be placed far away from your hands and desks that can conduct electricity; otherwise, the measurement result might be inaccurate. The greater the measured resistance is, the greater the affect will be.

7. View history data

Up to 5000 latest measured data can be viewed. Press **History** to enter the following interface.

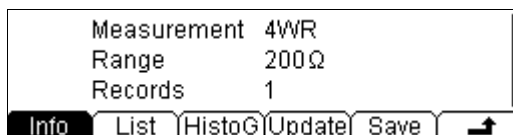
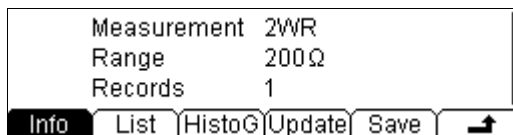

- Press **Info** and use the up and down direction keys to view the measurement item, measurement range, number of values, maximum,

minimum, average and standard deviation.

- Press **List** and use the up and down direction keys or the menu softkeys to view all the measurement results before the last update in table form.
- Press **HistoG** to view the histogram of the average (AVG) and standard deviation (SDEV).
- Press **Update** to update the "Records", "Maximum", "Minimum", "Average" and "SDEV" under **Info** and the display in **List** and **HistoG**.
- Press **Save** to enter the store and recall interface; at this point, **Save** is illuminated. You can save the current measurement data into internal memory or external USB storage device. For details, please refer to the introduction in "**Save and Recall**".

8. Hide the menu

Press **Hide** to hide the operation menus for easier observation of the measurement result. Press any softkey again to display the operation menus.

To Measure Capacitance

Range: 2 nF, 20 nF, 200 nF, 2 μ F, 20 μ F, 200 μ F, 2 mF, 20 mF, 100 mF

Max Resolution: 1 pF (in 2 nF range)

Input Protection: a 1000 V input protection is available in all ranges. 10% overrange is available on all ranges.

Operating Steps:

1. Enable the CAP measurement

Press  at the front panel to enter the following interface.

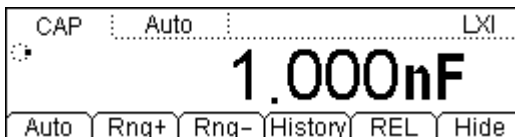

2. Make connection

Connect the test lead with the measured capacitance by referring to “**Measurement Connections**”.

Tip

Please short contact the two feet of an electrolytic capacitor by using a test lead before measuring the electrolytic capacitor.

3. Set the range

Specify an appropriate range (the resolution is fixed at $3\frac{1}{2}$ digits) according to the measured signal and measurement requirements.

4. Read the measurement value

The multimeter measures the measured capacitance according to the current measurement settings and displays the value on the screen.

5. Make math operation (advanced)

Users can perform math operation (STA, P/F, and REL) on each CAP measurement reading. For REL operation, the multimeter subtracts the

pre-specified value of REL from the actual measurement result and displays the result. For details, please refer to “**Math Operations**”.

6. View history data

Up to 5000 latest measured data can be viewed. Press **History** to enter the following interface.

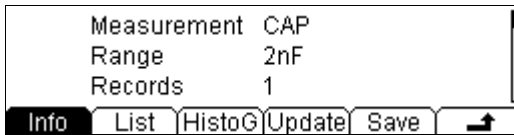

- Press **Info** and use the up and down direction keys to view the measurement item, measurement range, number of values, maximum, minimum, average and standard deviation.
- Press **List** and use the up and down direction keys or the menu softkeys to view all the measurement results before the last update in table form.
- Press **HistoG** to view the histogram of the average (AVG) and standard deviation (SDEV).
- Press **Update** to update the “Records”, “Maximum”, “Minimum”, “Average” and “SDEV” under **Info** and the display in **List** and **HistoG**.
- Press **Save** to enter the store and recall interface; at this point, **Save** is illuminated. You can save the current measurement data into internal memory or external USB storage device. For details, please refer to the introduction in “**Save and Recall**”.

7. Hide the menu

Press **Hide** to hide the operation menus for easier observation of the measurement result. Press any softkey again to display the operation menus.

To Measure Continuity

Test Current Source: 1 mA

Max Resolution: 0.1 Ω (the range is fixed at 2 k Ω)

Input Protection: 1000 V Input Protection.

Open-circuit Voltage: < 8 V

Beep Threshold (short-circuit resistance): from 1 Ω to 2000 Ω

Operating Steps:

1. Enable the CONT measurement

Press  at the front panel to enter the following interface.



2. Make connection

Connect the test lead with the measured circuit by referring to "Measurement Connections".

3. Set the short-circuit resistance

Press **Set** and enter a desired value using the direction keys. The range is from 1 Ω to 2000 Ω and the default is 10 Ω .

4. Read the measurement value

- The circuit is considered to be connected when the measured circuit has a resistance lower than the specified short-circuit resistance. The actual resistance value is displayed on the screen and the beeper sounds (if the sound is on).
- When the measured circuit has a resistance that is between the specified short-circuit resistance and 2.2 k Ω , the actual resistance value is displayed but the beeper does not sound.
- When the measured circuit has resistance greater than 2.2 k Ω , "OPEN" is displayed on the screen but the beeper does not sound.

5. Hide the menu

Press **Hide** to hide the operation menus for easier observation of the measurement result. Press any softkey again to display the operation menus.

To Measure Diode

Test Current Source: 1 mA, 100 μ A, 10 μ A, 2 μ A, 200 nA

Voltage Measurement Range: -0.2 V ~2.2 V, -0.2 V ~4.2 V, -0.2 V ~4.8 V, -0.2 V ~5.2 V, -0.2 V ~5.5 V

Max Resolution: 100 μ V

Input Protection: 1000 V Input Protection.

Open-circuit Voltage: < 8 V

This function measures the forward voltage drop on the diode.

Note: in diode measurement, please connect the diode and multimeter using connecting wire that is as short as possible to avoid the error generated by the reception of space electromagnetic signal by the connecting wire loop.

Operating Steps:

1. Enable the DIODE measurement

Press  at the front panel to enter the following interface.



2. Make connection

Connect the test lead with the measured diode by referring to "Measurement Connections".

3. Select the current source*

Press **1mA**, **100uA**, **10uA**, **2uA** or **200nA** to select the desired current source.

Note: when measuring diode with relatively larger drain current, please do not use small current source (the polarity of the diode might not be distinguished because the forward voltage drop might be too low).

4. Read the measurement value

The multimeter screen displays the measured voltage value when the diode is connected; otherwise the screen displays "OPEN".

5. Hide the menu

Press **Hide** to hide the operation menus for easier observation of the measurement result. Press any softkey again to display the operation menus.

Remark*: this function is added since the 01.01.00.01.07.00 version but only the performance of the 1 mA current source is guaranteed.

To Measure Frequency and Period

Frequency (Period) Range: from 3 Hz to 1 MHz (from 0.33 s to 1 μ s)

Input Signal Range: 200 mV, 2 V, 20 V, 200 V, 750 V

Input Protection: a 750 V input protection is available in all ranges.

To obtain the measured signal's frequency and period, directly press  or use the secondary measurement function during voltage or current measurement.

Operating Steps:

1. Enable the FREQ/PERIOD measurement

Press  at the front panel to select frequency/period measurement and to enter either interface shown below.

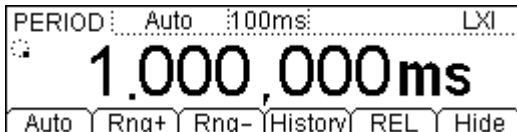
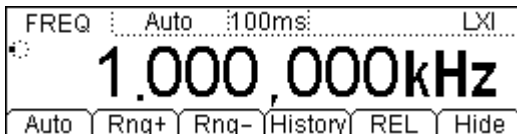

2. Make connection

Connect the test lead with the measured signal by referring to **"Measurement Connections"**.

3. Set the range

Specify an appropriate range (the resolution is fixed at $6^{1/2}$) according to the measured signal and measurement requirements.

4. Set the measurement parameters (Optional)

In FREQ/PERIOD measurement, you can set the gate time and filter as required. For details, please refer to **"Measurement Configuration"**.

5. Read the measurement value

The multimeter measures the input signal according to the current measurement settings and displays the value on the screen. Besides, the multimeter can measure the voltage or current of the signal during the frequency/period measurement. Press $\sim V$ or $\sim I$ and then press FREQ and Freq respectively; the measurement results are as shown in the figures below.

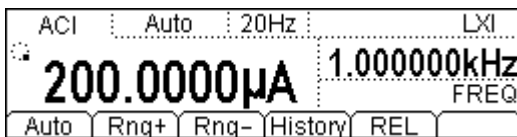
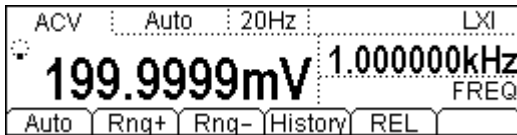

6. Make math operation (advanced)

Users can perform math operation (STA, P/F and REL) on each measurement reading. For REL operation, the multimeter subtracts the pre-specified value of REL from the actual measurement result and displays the result. For details, please refer to “Math Operations”.

7. View history data

Up to 5000 latest measured data can be viewed. Press **History** to enter the following interfaces.

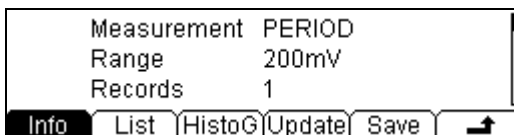

- Press **Info** and use the up and down direction keys to view the measurement item, measurement range, number of values, maximum, minimum, average and standard deviation.
- Press **List** and use the up and down direction keys or the menu softkeys to view all the measurement results before the last update in table form.

- Press **HistoG** to view the histogram of the average (AVG) and standard deviation (SDEV).
- Press **Update** to update the “Records”, “Maximum”, “Minimum”, “Average” and “SDEV” under **Info** and the display in **List** and **HistoG**.
- Press **Save** to enter the store and recall interface; at this point, **Save** is illuminated. You can save the current measurement data into internal memory or external USB storage device. For details, please refer to the introduction in “**Save and Recall**”.

8. Hide the menu

Press **Hide** to hide the operation menus for easier observation of the measurement result. Press any softkey again to display the operation menus.

Any Sensor Measurement

This function enables you to easily convert a measured physical quantity (such as pressure, flow rate and temperature) into a quantity that can be easily measured (such as voltage, current or resistance). By pre-inputting a response curve, the multimeter converts and amends the data according to the internal arithmetic and displays the physical quantity measured on the screen. Users can edit and modify the display unit of the measured physical quantity at will.

DM3068 supports user-defined (DCV, DCI, 2WR, 4WR, FREQ) and temperature (TC, RTD, THERM) sensor measurements. Press  to enter the following interface.

Project name of current sensor

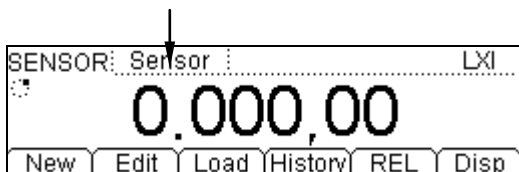

- **New:** create a new sensor configuration file.
- **Edit:** modify the currently opened or stored sensor configuration file. The operation method is similar to that of **New**.
- **Load:** load the sensor configuration files stored in the internal nonvolatile memory or USB storage device. For details, please refer to “**Save and Recall**”. The backlight of  goes on when you use this function.
- **History:** display up to 5000 latest measurement data.
- **REL:** quickly enable the REL operation. Besides, you can perform STA and P/F operations. For details, please refer to “**Math Operations**”.
- **Disp:** set the display mode of the result from sensor measurement. **Meas** indicates that only the measurement value will be displayed; while **Corrsp** indicates that only the corresponding value will be displayed. **All** indicates that both the measurement value (on the vice display) and the corresponding value (on the main display) will be displayed. The corresponding value refers to the value of measured physical quantity.

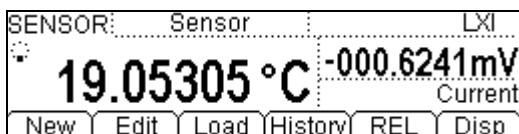

The following part introduces how to create a sensor configuration file in details. For DCV, DCI, 2WR, 4WR or FREQ sensor, you can define a fitting curve. Since the temperature sensor (TC, RTD, THERM) converts the electrical signal (such as voltage or resistance) to temperature using the software conversion program inside the instrument, you can directly choose a desired temperature sensor.

User-defined Sensor

Press **Sensor** → **New** → **User** to enter the following interface.

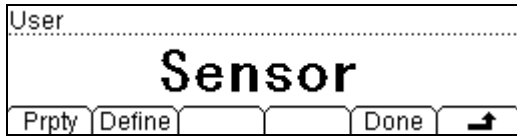

- **Prpty**: set the sensor name, type and unit.
- **Define**: define the response curve of the sensor.

1. Define the Sensor Name

Press **Prpty** → **Name** to enter the following interface and enter a name that is easy to understand for the newly defined sensor. The name should be within 9 characters.

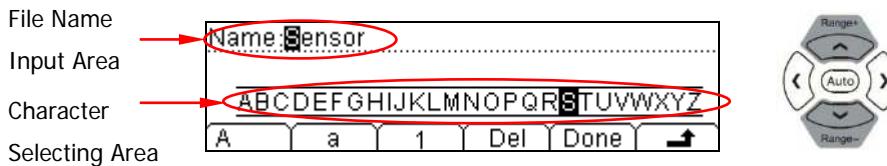

Name/File Name Input Method

Press the up or down direction key to place the cursor in the File Name Input Area or Character Selecting Area.

- When the File Name Input Area is selected, the Character Selecting Area is hidden automatically and you can select the cursor position to be edited by pressing the right and left direction keys (or press and hold the key).
- In Character Selecting Area, choose the desired character using the right and left direction keys. At this point, the character in the File Name Input Area changes accordingly (after choosing the desired character, select the File Name Input Area and press the right direction key to confirm the character selected and move the cursor to the next position).

Uppercase letter, lowercase letter and number can be use for defining the name.

- **A**: input uppercase letters (A-Z).
- **a**: input lowercase letters (a-z).
- **1**: input numbers (0-9).

- **Del:** delete the character where the cursor locates.
- **Done:** finish the name input.
- **↶:** return to the upper-level menu.

2. Specify the Sensor Type

Press **Prpty** → **Type** to enter the following interface and select the type of the electric signal to be converted by the sensor. Press **↶** to return to the upper-level menu.



Note: if DCI is selected, please press **mA** before the following operations.

3. Select the Sensor Unit

Press **Prpty** → **Unit** to enter the interface below and select a desired unit for the corresponding measurement result. When **USER** is selected, you can define a unit up to 2 characters using the direction keys. Press **↶** to return to the upper-level menu.

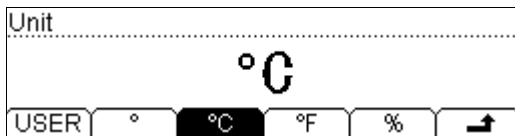

4. Define the Sensor Arithmetic Curve

Press **Define** → **Add** to enter the following interface, from which you can add data pairs on the curve. The multimeter fits the relation curve function of the input signal and measurement result using the specified arithmetic according to these data pairs and then calculates the output result using this function according to the input signal.

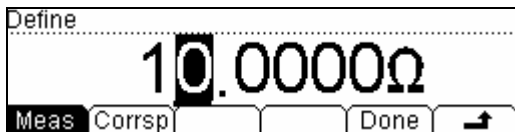

Press **Meas** and enter the data of the physical quantity measured using the direction keys. Here, as the sensor type is 2WR, the unit is Ω .

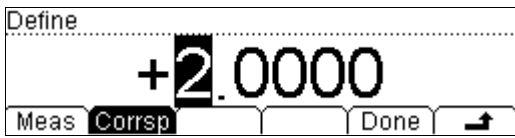

Press **Corrsp** and enter the data of the corresponding physical quantity using the direction keys. The unit to be used is the one (°C) you have set in step 3.

For different type of sensor, the data range available is different.

Table 2-4 User-defined sensor measurement range

Type	Range
DCV	-1100 V to 1100 V
DCI	-220 mA to 220 mA
2WR	0 Ω to 110 MΩ
4WR	0 Ω to 110 MΩ
FREQ	0 Hz to 1100 kHz

Press **Done** to finish the input of a pair of data and enter the following interface. The icon  indicates the arithmetic for the data segment behind this data and before the next arithmetic mark. The default arithmetic for the first data segment is **Line** and you can modify it using **Edit**.

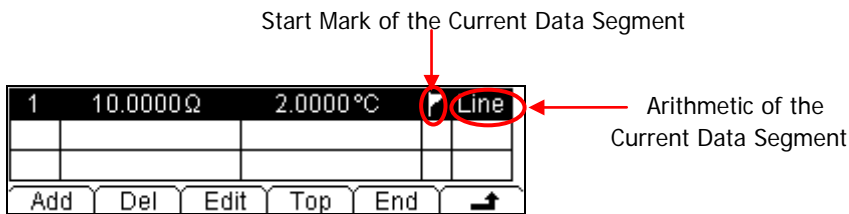

Press  to return to the upper-level menu and create the second group of data in the same way. From the second group of data on, you can use the segment function to set the arithmetic for different data segment.



Press **SEG** → **ON** → **Arith** and select **Line** or **Curve** arithmetic type.

Line: the calculated curve is point-point tangential path having no curvature. It applies to sensors having step-variation in the data or having variation based on straight slope and better linearity within a certain area. **This arithmetic requires that the data segment contains at least 2 groups of reference data.**

Curve: the calculated curve is an approximate result that has a certain curvature. It applies to data has unfavorable linearity. **This arithmetic requires that the data segment contains at least 5 groups of reference data.**

Tip

For some sensor, the corresponding relation curve might both contain data segment with good linearity (Line arithmetic is recommended) and data segment with poor linearity (Curve arithmetic is recommended); in this case, you need to use the segment function to define different arithmetic for different data segment.

5. Store and Recall Sensor Configurations

Input reference data pairs (measurement and corresponding values) for the arithmetic curve to be used and the interface as shown in the figure below is displayed.

1	10.0000Ω	2.0000°C	Line
2	12.0000Ω	2.5000°C	
3	15.0000Ω	3.0000°C	Curve
Add Del Edit Top End ↗			

Press  to finish the sensor property setting and returns to the **User** interface. Then, press **Done** to enter the following interface.

New					
.....					
			Save	Apply	↗

- Press **Save**, the multimeter enters the store and recall interface and the backlight of  goes on.

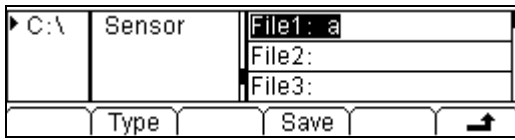

Press **Save** and enter a desired file name by referring to **"Name/File Name Input Method"**, such as "Sens1".

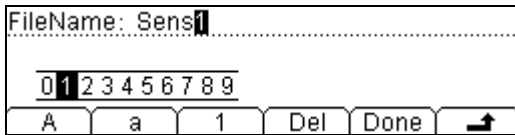

When finished, press **Done** to save the current sensor configuration into the internal memory (C:\) or external USB storage device (A:\) with the specified filename.

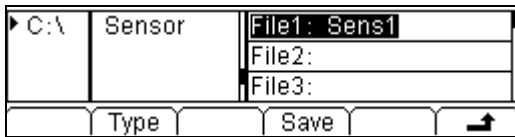

Press **↵** and returns to **User** interface.

- Press **Apply**, the multimeter starts measuring according to the current configurations. As shown in the figure below, the **▲** shown on the screen indicates that the result is unreliable.

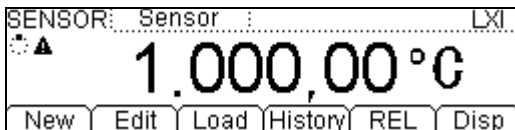

If you suspect the stored any sensor configuration files or data, press **Edit** to make a modification.

Temperature sensor

DM3068 can directly measure the temperature using TC (Thermocouple), RTD (Resistance Temperature Detector) and THERM (Thermistor) sensors.

For different temperature sensor, the conversion form and conversion characteristics of temperature and electrical signal are different. For different models of the same type of sensor, the characteristic parameters and temperature-electrical signal corresponding relations are different. A temperature sensor that conforms to ITS-90 standards should be used for measurement.

Press  → **New** → **Temp** to enter the following interface.

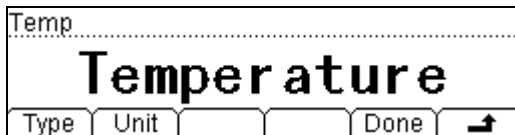

- **Type**: choose a desired temperature sensor type from TC, RTD and THERM and set the related parameters.
- **Unit**: choose the unit of the measured temperature from °C, °F and K. The conversion relations between these units are:

$$^{\circ}\text{F} = (9/5) * ^{\circ}\text{C} + 32$$

$$\text{K} \approx ^{\circ}\text{C} + 273.15$$
- **Done**: save or apply the current temperature sensor configurations.
- Press  to return to the upper-level menu.

For the temperature sensor measurement, connect the test lead and device under test by referring to the connection method in “**Measurement Connections**”.

The following parts introduce the measurement parameters of each temperature sensor.

TC

The TC (thermocouple) is one of the most commonly used industrial temperature detection device. It converts the temperature value into voltage reading, and has a very large temperature measurement range.

The common thermocouples are B (Pt Rh 30- Pt Rh6), E (NI CR-WRCK), J (Fe-WRCK), K (NI CR-NiSi), N (NiCrNi-NiSi), R (Pt Rh13 -Pt), S (Pt Rh10-Pt) and T (Cu-WRCK). Among them, B, R and S are precious metal thermocouple, while E, J, K, N and T are cheap metal thermocouples. For the reference table about each thermocouple, please see the ITS-90 standards.

The DM3068 provides two cold junction compensation modes: **internal cold junction temperature & user-defined cold junction temperature.**

Internal cold junction temperature refers to the internal temperature of the banana jack detected by the multimeter. Connect the thermocouple wire to the inside of the banana jack and prevent air flow from interfering the temperature around the banana jack. The radiating structure on the banana jack connected with the thermocouple wire would cause additional cold junction temperature error. About 3-minute warm-up is needed to build up the thermal balance after the cold junction is connected.

User-defined cold junction temperature refers to the temperature at the cold junction compensation point of the thermocouple. The internal temperature of the banana jack might be different from the actual temperature at the cold junction compensation point. If external cold junction compensation equipment is used, the thermocouple voltage signal compensated can not be connected to the banana jack through the compensation lead; otherwise, additional cold junction error will be caused. The accuracy of the measurement when using simulated cold junction depends on the accuracy of cold junction compensation.

To use the TC sensor, you should select the type of the thermocouple and the compensation mode of the cold junction.

Press **TC** → **Type** to select the desired thermocouple type and press **↵**.

Press **TC** → **JUNC**, select **INT** or **SIM** to input correct cold junction temperature (with -273 and 999) and then press **↵**.

RTD

RTD is a temperature detector commonly used in medium-low temperature range. It features in high measurement accuracy and stable performance. It measures the temperature depending on the changing resistance of the measured substance with the temperature. The multimeter will display the temperature corresponding to the resistance when the resistance changes. This kind of sensor has good linearity.

The multimeter adopts the approximate arithmetic of IEC751 standards and converts the resistance signal from the temperature sensor into the related temperature for displaying. For the reference table about each RTD, please refer to the related standards.

To use the RTD sensor, set the measurement parameters according to the following steps.

1. Set the R0 Value

Press **RTD** → **R0** and enter a desired value within 49 Ω and 2100 Ω using the direction keys, the default is 100 Ω .

2. Set the Temperature Coefficient

Press **RTD** → **ALPHA** and select a desired value from 385 (0.00385), 389 (0.00389), 391 (0.00391) and 392 (0.00392).

3. Set the Connection Type

The RTD lead usually uses 2-wire or 4-wire connection. Press **RTD** and then press **2WR** or **4WR** to select the desired option; then, press **↩** to return to the upper-level menu.

THERM

The THERM (thermistor) converts the temperature variation information into resistance variation information. It is especially sensitive to temperature.

In this measurement, the multimeter adopts Steinhart-Hart approximate arithmetic and converts the resistance signal from the temperature sensor into the related temperature for displaying.

To use the THERM sensor, you need to set the resistance parameter of the multimeter and select the connection mode.

1. Set the resistance parameter

Press **THERM** → **Type** and select a desired value from 2.2K (2.2 kΩ), 3K (3 kΩ), 5K (5 kΩ), 10K (10 kΩ) and 30K (30 kΩ).



2. Set the connection type

Press **THERM** and then press **2WR** or **4WR** to set the connection mode to 2-wire or 4-wire.

Press **↶** to return to the upper-level menu.



Preset Mode

Preset mode applies to production lines for avoiding misoperations.

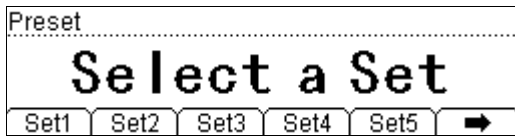
Press  in any mode to enter the following interface, from which you can choose a preset configuration from up to 10 groups. Note the configurations in this interface correspond to the 10 groups of system configurations in the internal memory ( →  → Sys Setting).





Press  (n=1 to 10); if an effective configuration is stored in the storage unit corresponding to this key, the beeper sounds and the instrument recalls the configuration stored directly; if the storage unit selected is empty, the instrument returns to the previous test state directly.

Press  →  → , the multimeter stores the current measurement configuration into the memory unit corresponding to the key using the set name **Setn**.

Besides, you can recall or save preset configurations using  function. For details, please refer to "**Save and Recall**".

Secondary Function Key

The secondary function key  is used to enable the dual display mode, quickly store the current instrument settings in co-ordination with  and quickly enter the REL setting interface.

1. Turn On the Dual Display

This mode enables you to simultaneously measure both voltage or current and frequency of an ac signal. The voltage or current value is shown on the main display, while the frequency is shown on the vice display.

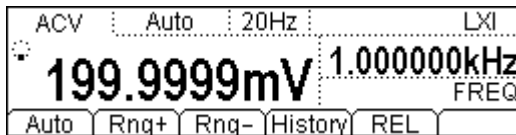

For example, press  →  →  to enter the following interface.



Note:



- The multimeter measures the two parameters at the same time and the main and vice displays update respectively.
- If the measurement from the main display uses math operation (STA <MAX, MIN, AVG, ALL>, P/F, dBm, dB), turning on the vice display will automatically disable the math operation in use, while the vice display presents the measurement value of the vice display function.
- The math operation (MAX, MIN, AVG, dBm, dB, REL) only works with the main display when dual display function is used. Turning on P/F will automatically disable the dual display.
- If the measurement on the main display uses math operation (REL), turning on the vice display will not change the display result on the main display and the vice display presents the measurement value of the vice display function.

2. Quickly Store Current Settings

Press  →  → **Setn**, the multimeter stores the current measurement configurations into the memory unit corresponding to the key with the name "**Setn**". You can also use  to perform the operation; for details, please

refer to “**Save and Recall**”.

3. Quickly Enter REL Setting Interface

In addition to  button, you can press  → REL in common measurement interface to directly enter the REL setting interface.

Measurement Configuration

Most measurement parameters are user-defined. Changing a measurement parameter will change the measurement precision and speed as well as the input impedance. An appropriate measurement parameter based on the actual application will ensure faster measurement or higher measurement precision.

The default measurement configurations of the multimeter can ensure the accuracy of the measurement results in most cases. Users can directly use these defaults for any measurement or modify the parameters of the measurement function as required.

The parameters for different measurement function differ, see table below.

Table 2-5 Measurement parameter

Functions	Parameters
DCV	integration time, DC impedance, Auto zero (AZ)
ACV	AC filter
DCI	integration time, Auto zero (AZ)
ACI	AC filter
OHM (2WR, 4WR)	Integration time, Auto zero (AZ), Offset compensation (OC)
CAP	N/A
CONT	Short-circuit resistance
DIODE	Current Source
FREQ/PREIOD	Gate time, AC filter
SENSOR	N/A

To set the measurement parameter, select a measurement function and then press . For more details, please refer to the following content.

Integration Time

Integration time is the period during which the multimeter's analog-to-digital (A/D) converter samples the input signal for a measurement. The longer the integration time is, the slower the measurement speed will be and the higher the resolution will be; the shorter the integration time is, the faster the measurement will be and the lower the resolution will be. The integration time applies to DCV, DCI, 2WR and 4WR measurements.

DM3068 provides two integration time setting modes:

- **NPLC**: express the integration time by the power line cycles, the unit is PLC. It can be set to 0.006, 0.02, 0.06, 0.2, 1, 2, 10 and 100 and the default is 10. For the relationship between the integration time and resolution, please see "Table 2-1". The multimeter automatically detects the input power frequency at power-on and considers frequencies within 55 Hz and 66 Hz as 60 Hz and others as 50 Hz.
- **APER**: express the integration time by aperture time. The range is from 100 μ s to 1s and the default is 100 ms.

In DCV, DCI, 2WR or 4WR measurement, press  → **INTEG** to enter the following interface.

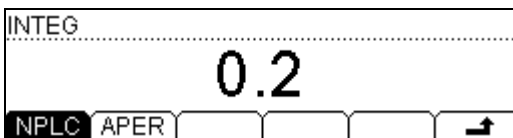



- **NPLC**: choose a desired integration time and then press  to return to the upp-level menu.
- **APER**: set a desired integration time using the direction keys and then press **Done**.

The setting is stored in nonvolatile memory.

DC Impedance

DC impedance applies to DCV measurement. The default is “10MΩ” and is stored in non-volatile memory. In the range of 200 mV, 2 V or 20 V, you can choose “>10GΩ” to reduce the loading error to the measured object caused by the multimeter (refer to “**Loading Errors (DCV)**”). The current selection is stored in volatile memory.

In DCV measurement, press  →  to enter the following interface.

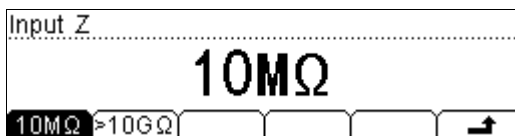

Press  or  to select the desired impedance.

- **10MΩ**: set the input impedances in all ranges to 10 MΩ.
- **>10GΩ**: set the input impedances in ranges of 200 mV, 2 V and 20 V to >10 GΩ, while in ranges of 200 V and 1000 V, the impedances are still 10 MΩ.

Auto Zero

Auto zero (Auto Zero) applies to DCV, DCI, 2WR and 4WR measurements.

Press  → **AZ** to enter the following interface.

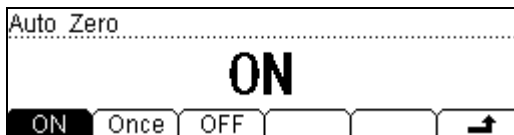

- **ON**: the multimeter internally disconnects the input signal and measured circuit after each measurement, and takes a zero reading. It then subtracts the zero reading from the preceding reading (displaying the difference between the measurement value and zero value during the measurement), in order to reduce the impact of offset voltage from input circuit on measurement result.
- **Once**: the multimeter takes a zero reading and then disables the auto zero. The multimeter will subtract this zero reading from the following measurement value.
- **OFF**: disable the auto zero function. Whatever, the multimeter automatically takes a zero reading once the function, range or integration time is changed. The multimeter will subtract this zero reading from the following measurement value.

Offset Compensation

OC (Offset Comp) applies to resistance measurements in the range of 200 Ω , 2 k Ω and 20 k Ω . It eliminates the impact of small dc offset from test lead on measurement result.

In 2WR or 4WR measurement, when the range is set to 200 Ω , 2 k Ω or 20 k Ω , press **Meas** → **OC** to enter the following interface.

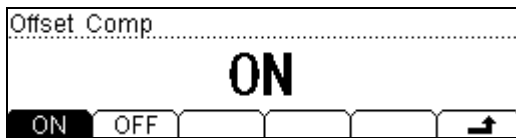

- **ON**: the multimeter adds two different currents onto the measured resistance and measures the variation of the voltage between both ends of the resistance under the two different currents, and then divides the voltage variation by the current variation to obtain the value of the measured resistance.
- **OFF**: the multimeter does not execute offset compensation.

Tip

The offset compensation and auto zero are mutually exclusive. The used auto zero function will be disabled automatically once you turn on the offset compensation, and vice versa.

AC Filter

AC filter applies to ACV, ACI and FREQ/PERIOD measurements. It can optimize the low-frequency accuracy and minimize the AC settling time. DM3068 provides three types of AC filters (slow, medium and fast). The AC filter to be used is determined by the input signal frequency.

Input Frequency	AC Filter
3 Hz to 300 kHz	Slow
20 Hz to 300 kHz	Mid
200 Hz to 300 kHz	Fast

In ACV, ACI or FREQ/PERIOD measurement, press  → **Filter** to enter the following interface.

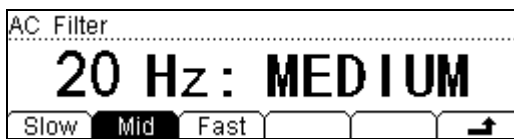

Press **Slow**, **Mid** or **Fast** to select 3 Hz, 20 Hz or 200 Hz as the lowest frequency of the AC filter. The default is 20 Hz: MEDIUM.

Short-Circuit Resistance

This function only applies to continuity test. When the measured circuit has a resistance lower than the short-circuit resistance, the circuit is considered as connected, and the beeper sounds (if sound is on). The default short-circuit resistance is $10\ \Omega$ and the setting is stored in nonvolatile memory.

When continuity test is enabled, press  → **Conti** to enter the following interface.

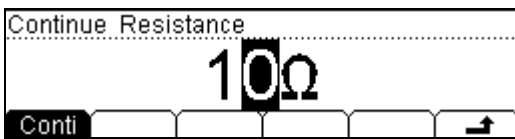



Set a desired value using the direction keys. The range is from $1\ \Omega$ to $2000\ \Omega$

Current Source

Current source applies to the diode measurement function. The current selected is applied to the diode under test and the multimeter measures the voltage drop between the two ends of the diode to determine the polarity of the diode.

Note: when measuring diode with relatively larger drain current, do not use the small current source (as the forward voltage drop measured might be too low to determine the polarity of the diode).

In DIODE measurement, press  to enter the following interface. The current sources available are 1 mA, 100 μ A, 10 μ A, 2 μ A and 200 nA and the corresponding voltage ranges are -0.2 V ~2.2 V, -0.2 V ~4.2 V, -0.2 V ~4.8 V, -0.2 V ~5.2 V and -0.2 V ~5.5 V. You can also press  to select the desired current source.

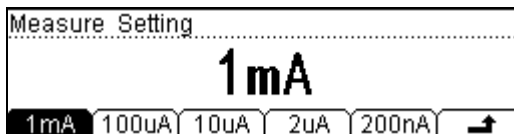

Gate Time

Gate time (also called Aperture Time) applies to FREQ/PERIOD function. It decides the resolution of low-frequency measurement. The longer the gate time is, the higher the resolution of the low-frequency measurement is and the slower the measurement is, and vice versa. For details, please refer to “**Specifications**”.

In FREQ/PERIOD measurement, press  → **GATE** to enter the following interface.

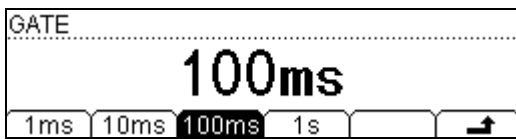

The gate time can be set to 1 ms, 10 ms, 100 ms or 1 s and the default is 100 ms. You can select a desired gate time by pressing the corresponding softkey.

Math Operations

DM3068 provides basic math operations (STA, P/F, dBm, dB and REL) for measurement results and displays the history data through tendency graph and histogram.

In DCV, ACV, DCI, ACI, 2WR, 4WR, CAP, FREQ/PERIOD or SENSOR measurement, press **Math** to enter the following interface.

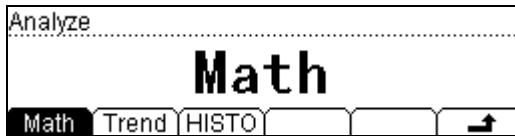

- **Math**: enter the math function setting interface.
- **Trend**: enter the tendency graph interface.
- **HISTO**: enter the histogram interface.

Math

The multimeter provides 5 math functions: STA (MAX, MIN, AVG and ALL), P/F, dBm, dB and REL. Different measurement function allows different math functions as shown in the table below.

Table 2-6 Math Operation

Measurement Function	Available Math Functions
DCV	STA, P/F, dBm, dB, REL
ACV	STA, P/F, dBm, dB, REL
DCI	STA, P/F, REL
ACI	STA, P/F, REL
OHM (2WR, 4WR)	STA, P/F, REL
CAP	STA, P/F, REL
CONT	N/A
DIODE	N/A
FREQ/PREIOD	STA, P/F, REL
SENSOR	STA, P/F, REL

Take the DCV for instance. Press  → **Math** to enter the following interface.



Press the related menu to enter the desired measurement setting interface. Note that you can only use one math operation from STA, P/F, dBm and dB at a time, but REL can be used together with any of the four at the same time.

STA

STA calculates the min, max, average and mean square deviation of readings during the measurement.

Press **STA** to enter the following interface.

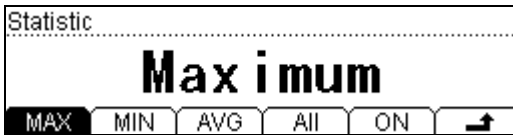

After you choose a desired STA function, press **ON** to enable it and the multimeter enters the reading interface. The reading updates during the measurement.

- When **MAX** or **MIN** is selected, the multimeter takes the first reading as the maximum (or minimum) for displaying. The reading shown on the screen is always the maximum (or minimum) within the current readings when measuring more consecutive readings. The measurement interface displays the maximum (or minimum) reading, current measurement value and number of samples.
- When **AVG** is selected, the multimeter always displays the average value of all the current readings. The measurement interface displays the average value, current measurement value and number of samples.
- When **All** is selected, the measurement interface displays the current measurement value as well as the maximum, minimum, average and mean square deviation of the measured readings and number of samples.

P/F

P/F operation prompts the signal testing result (message display and beep) according to the specified high and low limit parameters and outputs a negative pulse through the RS232 interface at the rear panel. As shown in the figures below, the multimeter outputs a negative pulse from the Pin 1 (or Pin 9) if the test succeeds (or fails).

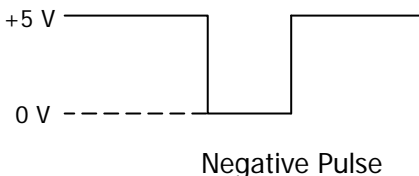
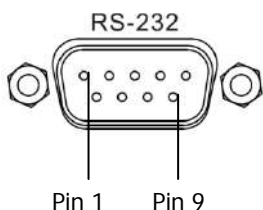

Press **P/F** to enter the following interface.

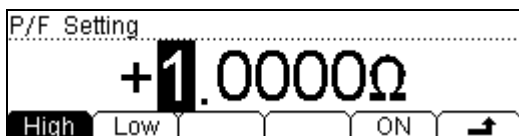

Press **High** or **Low** and enter a desired value using the direction keys. Note that the high limit should always be greater than the low limit and the unit is decided by the current measurement function. The range of the limit is from -110% to +110% of the maximum range of the selected measurement function. The settings are stored in volatile memory and will be cleared automatically at power-off.

After you setting the desired parameters, press **ON** to enable the P/F operation. The multimeter automatically exits the P/F setting interface and goes to the measurement main interface as shown in figure below.

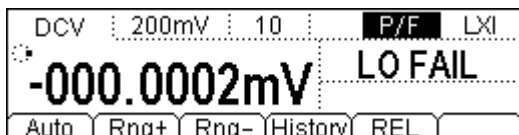

- The status bar displays "P/F".
- The main display contains the current measurement reading.
- The vice display displays "PASS" if the test succeeds.

- If the current reading exceeds the high or low limit, the vice display shows “HI FAIL” or “LO FAIL” and the beeper sounds (beeper is on:  → System → Sound).

**WARNING**

The P/F signal from pins 1 and 9 of RS232 is not compatible with the handshake signal (Carrier Detect and Ring Indicator) from standard RS232.

dBm

dBm represents the absolute value of the power. The dBm operation calculates the power of the reference resistance according to the measured voltage.

$$\text{dBm} = 10 \times \text{Log}_{10} [(\text{Reading}^2 / R_{\text{REF}}) / 1 \text{ mW}]$$

Wherein, Reading denotes the measured voltage and R_{REF} denotes the reference resistance.

Press **dBm** to enter the following interface, from which you can use the direction keys to specify a reference resistance within 2 Ω and 8000 Ω . The setting is stored in volatile memory and will be cleared automatically at power-off.

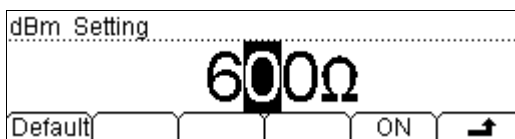

Default: restore the reference resistance to 600 Ω .

On: enable dBm operation. The multimeter then automatically goes to the measurement main interface, as shown in the figure below.

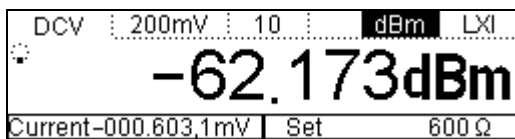

- The status bar displays “dBm”.
- The dBm operation result is displayed at the center of the screen.
- The current measurement reading and the reference resistance are displayed at the lower left corner and lower right corner of the screen respectively.

dB

dB represents the relative value which is used in the REL operation of dBm value. When enabled, the multimeter calculates the dBm value of the next reading and subtracts the preset dB from this value and then displays the result.

$$\text{dB} = 10 \times \text{Log}_{10} [(\text{Reading}^2 / R_{\text{REF}}) / 1 \text{ mW}] - \text{dB preset}$$

Wherein, Reading denotes the measured voltage and R_{REF} denotes the reference resistance.

Press **dB** to enter the following interface, from which you can use the direction keys to specify a value within -120 dBm and +120 dBm (the unit is dBm). The setting is stored in volatile memory and will be cleared automatically at power-off.

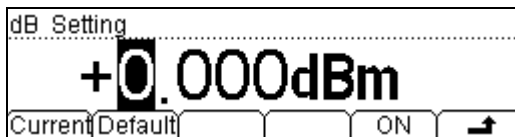

Current: calculate the dBm value on the basis of the reference resistance from the present **dBm** menu.

Default: restore the dB preset value to 0 dBm.

On: enable dB operation. The multimeter then automatically goes to the measurement main interface, as shown in the figure below.

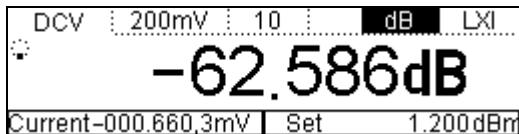

- The status bar displays "dB".
- The dB operation result is displayed at the center of the screen.
- The current measurement reading and the dB preset value are displayed at the lower left corner and lower right corner of the screen respectively.

REL

The reading displayed on the screen in REL operation is the difference between measured and preset values.

$$\text{Reading} = \text{measured value} - \text{preset value}$$

Users can pre-specify a REL value by any of the following way:

- 1) In basic measurement interface, press **REL** and the multimeter automatically uses the current measurement result as the preset value.
- 2) In basic measurement interface, press **Math** → **Math** → **REL** to enter the preset value setting interface.
- 3) In basic measurement interface, press **REL** → **REL** to enter the preset value setting interface.

In the preset value setting interface, you can directly use the direction keys to specify a preset value. The unit is decided by the current measurement function.

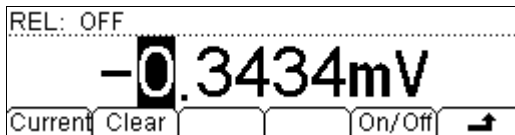

Current: set the preset value to the current reading.

Clear: restore the preset value to 0.

On/Off: enable or disable REL operation. When it is on, pressing **↔** will go to the measurement main interface, as shown in the figure below.

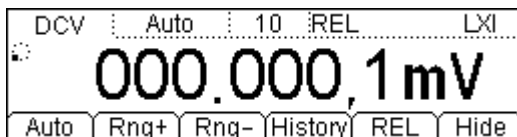

- The status bar displays "REL".
- The REL operation result is displayed at the center of the screen.
- Re-pressing **REL** under the main interface will close the REL operation. The identifier "REL" disappears.

Tendency Graph

The multimeter draws tendency graph of the measured data through which users can directly observe the variation of the measured data without other supplementary means. This function is available for DCV, DCI, ACV, ACI, 2WR, 4WR, CAP, FREQ/PERIOD and SENSOR measurements.

Press Math \rightarrow **Trend** to enter the following interface. The screen displays the MAX and MIN values of the measured data, the drawing time of the tendency graph as well as the real-time curve and tendency graph of the measured data. The multimeter supports up to 999 hours 59 minutes and 59 seconds drawing time. When the drawing time exceeds this limit, the timer is reset and starts to time again (but the waveform drawn is kept). When the real-time curve reaches the maximum display length, it is compressed and added onto the tendency graph and the multimeter starts to draw new real-time curve. When the tendency graph reaches the maximum display length, it is compressed into half to make sure that the compressed data on the real-time curve can be added onto it continuously to form cumulative tendency graph.

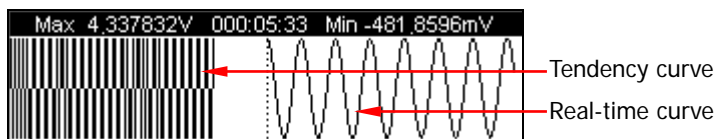

Press any soft menu at this moment to open the operation menu as shown in figure below.



Press **Stop**, the multimeter stops drawing and enters the following interface.

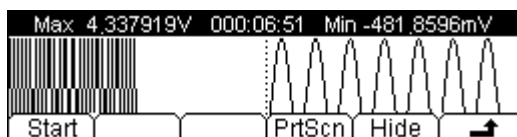

- **Start**: enable the multimeter to redraw the graph according to the current

measurement data.

- **PrtScn**: save the current tendency graph under the root directory of an external USB storage device in BMP format. Note: make sure that a USB storage device is correctly connected before using this function.
- **Hide**: hide the operation menu.

Histogram

The real-time histogram displays the distribution situation of the measurement data from DCV, DCI, ACV, ACI, 2WR, and 4WR, CAP, FREQ/PERIOD and SENSOR.

Note that different from the histogram in basic measurements (☰V → History → HistoG), the histogram changes in real time.

Press (Math) → HISTO to enter the following interface. The average (AVG), standard deviation (SDEV) and a histogram of measured data are displayed on the screen and update accordingly during the measurement.



Press any soft menu at this moment will open the operation menu as shown in figure below.

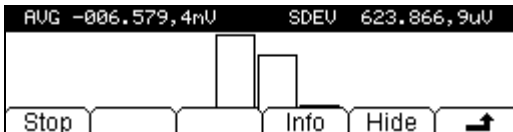

Press **Stop**, the multimeter stops updating histogram and enters the following interface.



- **Start**: enable the multimeter to redraw the histogram according to the current measurement data.
- **Info**: provide information about the current measurement.
- **Hide**: hide the operation menu.

Trigger

DM3068 provides four types of triggers: auto, single, external and level. It reads one or more specified number of readings (up to 50 000) each time a trigger signal is received and allows users to set the delay time between the start of trigger and reading.

Press  at the front panel to enter the following interface.

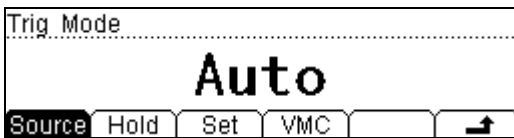

- **Source:** choose a trigger source from Auto, Single, Ext, and Level.
- **Hold:** enable or disable the reading hold function.
- **Set:** set the related parameters.
- **VMC:** enable or disable the trigger output.

To Select a Trigger Source

Press **Trig** → **Source** to enter the following interface. The default is Auto.



Auto Trigger:

Press **Auto** and **Done** to enable the auto trigger. The backlight of **Run Hold** at the front panel then turns on, and the multimeter continuously takes readings at the fastest possible speed according to the current configuration. At this point, pressing **Run Hold** will enable the reading hold function; the backlight will flicker and a stable reading will be captured and held on the screen.

Single Trigger:

Press **Single** and **Done** to enable the single trigger. The backlight of **Single** at the front panel then goes on. The multimeter takes one or specified number of readings every time you press **Single**.

External Trigger:

Press **Ext** and **Done** to enable the external trigger. The backlights of both **Run Hold** and **Single** at the front panel then go off. The multimeter will then receive the trigger pulse from the **[Ext Trig]** connector at the rear panel and trigger at the specified edge of the pulse signal and acquire measured data.

Level Trigger:

This mode applies to DCV/DCI/OHM measurement functions. Press **Level** and enter a desired level using the direction keys, then press **Done** to enable the level trigger. The backlights of both **Run Hold** and **Single** at the front panel then go off. The multimeter will trigger on the positive or negative edge of the input signal when the input level passes through the specified trigger level and acquire measured data.

Tip

Pressing **Single** in remote mode will switch the multimeter into local mode.

Reading Hold

The multimeter captures stable reading and holds it on the screen when the reading hold function is enabled.

The sensitivity range determines whether the reading is stable enough and can be displayed on the screen. This parameter is expressed in the form of reading percentage based on the current range. The multimeter will not capture and display new reading until three continuous readings exceed the selected sensitivity range.

Press **Trig** → **Hold** → **On/Off** to enter the following interface.

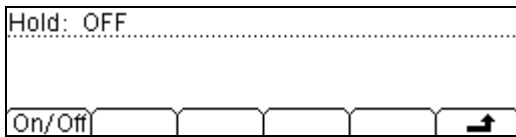

Press **On/Off** to enable or disable the reading hold function. When it is enabled, the backlight of **Run/Hold** at the front panel starts flashing. The settable sensitivity ranges are 0.01%, 0.1%, 1% and 10% and the default is 0.1%.

For example, if you choose 0.1%, the input signal into the multimeter is 5 V and the new reading will be displayed if three continuous readings exceed the range from 4.9975 V to 5.0025 V.

To Set the Trigger Parameters

Press **Trig** → **Set** to enter the following interface.

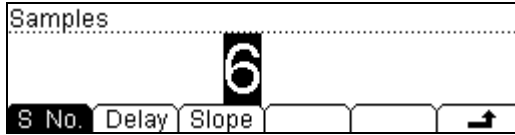

S No.

The multimeter takes the specified number of readings each time a trigger signal is received.

Press **S No.** and enter a desired number within 1 and 50 000 using the direction keys. The default is 1.

Delay:

User can set the delay time between the trigger signal and the every sample (reading).

Press **Delay** to enter the following interface.



- **Auto:** the delay time in this mode is decided by a combination of the used measurement function, range, integration time and AC filter and other factors.
- **ZERO:** the delay time in this mode is 0 s.
- **Manu:** the delay time in this mode can be set to any value within 0 s and 3600 s.

Slope:

This menu allows you to select an edge type for the pulse from the **[Ext Trig]** connector at the rear panel when using external (or level) trigger. The multimeter will trigger on the specified type of edge.

Trigger Output

Press  → **VMC** to enter the following interface.

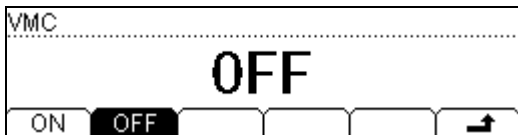

From this interface, you can enable or disable the trigger output. When it is enabled, the multimeter outputs a negative pulse from the **[VM Comp]** connector after each measurement.

Save and Recall

The multimeter allows you to save the system configuration or measurement data into the internal memory or an external USB storage device and recall it when required.

Press  to enter the following interface.



- **Disk:** choose a desired storage location. "C:\" indicates the internal memory, while "A:\" indicates the external USB storage device.
- **Type:** choose a desired file type for storing or reading. Please refer to "Storage Type".
- **Read:** read the selected file. This menu is available only when the current disk contains the specified type of file.
- **Save:** enter the filename input interface. This menu is available only when the current disk allows the specified type of file.
- **Erase:** clear the selected file. This menu is available only when the current disk contains the specified type of file.

Storage Type

The multimeter can save and recall various types of files.

- **MIRR_CFG**: save all system and sensor configurations files from the internal memory into an external USB storage device in one file. The filename suffix is ".xmir".
- **SysSetting**: save the current system configuration as an ".xmir" file.
- **MeasData**: save the current measurement data as an ".xdat" file.
- **MEAS_CSV**: save the current measurement result as a ".csv" file. To view the stored data, please use Microsoft Office Excel.
- **Sensor**: save the current sensor configuration as an ".xsen" file.
- **SensorData**: save the current sensor measurement data as an ".xsda" file.
- **SEN_CSV**: save the current sensor measurement data as a ".csv" file. You can view the stored data using Microsoft Office Excel.

Internal Storage

The internal memory (C:\) of the multimeter holds up to 10 groups of system configurations, 10 groups of measurement data, 5 groups of sensor configurations and 5 groups of sensor data.

External Storage

The external USB storage device (A:\) can save 7 types of files according to its capability.

To use the external storage, insert a USB storage device into the USB Host interface at the front panel and wait until an icon  appears in the status bar on the screen.

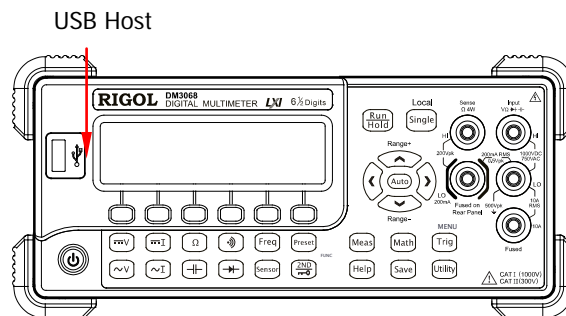

CAUTION

Do not remove the USB storage device under "A:\ " disk operations.

To Save a File

When the current storage disk allows specified file type, press **Save** to enter the following interface. The length of the file name should be within 9 characters.

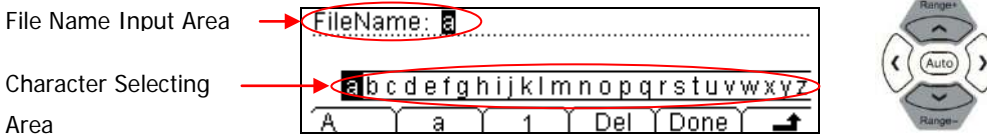

Name/File Name input method

Place the cursor to the File Name Input Area or Character Selecting Area using the up and down direction keys.

- In File Name Input Area, select the character to be edited by pressing the right and left direction keys (or press and hold the key), while the Character Selecting Area is hidden.
- In Character Selecting Area, choose the desired character by pressing the right and left direction keys. At this point, the character in the File Name Input Area changes accordingly (after choosing the desired character, select the File Name Input Area and press the right direction key to confirm the character selected and move the cursor to the next position).

The name allows uppercase and lowercase letters as well as numbers.

- **A**: input uppercase letters (A-Z).
- **a**: input lowercase letters (a-z).
- **1**: input numbers (0-9).
- **Del**: delete the character where the cursor locates.
- **Done**: finish the name entry.
- : return to the upper-level menu.

Utility

Set the parameters of the system-related functions.

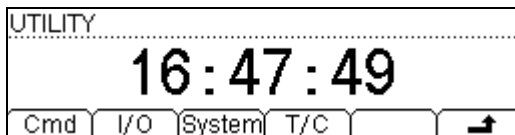

Press  to enter the following interface.



- **Cmd**: select a desired command system from those supported by DM3068.
- **I/O**: configure remote control interfaces such as LAN.
- **System**: set the system parameters such as language.
- **T/C**: execute self-test and view error information.

Command Set

DM3068 supports the command sets of RIGOL (DM3068), Agilent 34401A and Fluke 45.

Press  →  to enter the following interface, from which you can choose a desired command set.

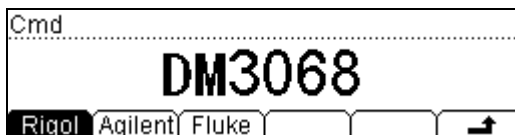

For more information about commands, please refer to the Programming Guide of DM3068.

Interface Configurations

Users can control DM3068 remotely by configuring the remote interfaces (LAN, GPIB, USB (configuration-free) and RS232).

Press  → I/O to enter the following interface.

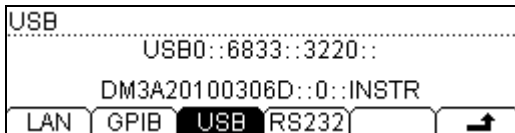

To Set the LAN

The LAN configuration parameters conform to LXI-C standards.

Before using this interface, connect the multimeter to the network using network cable.

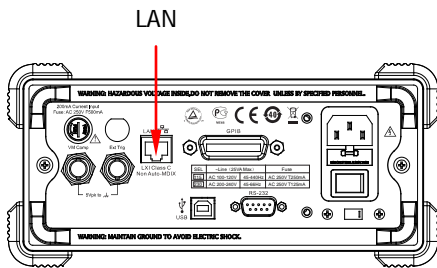

The LAN parameter configuration interface is as shown in the figure below.

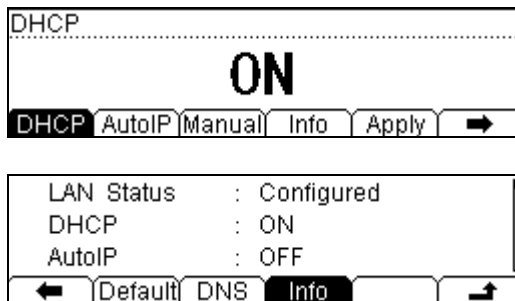

1. LAN Status

Display the current network connection status (LAN Status).

- **Configured**: indicate the LAN is connected.
- **Unlink**: indicate the LAN is not connected.

Press **Info** and use the up and down direction keys to view other information of network connection.

2. To Set IP Configuration Mode

The IP address configuration mode can be set to DHCP, AutoIP or ManualIP.

Different modes may have differences in parameter configuration.

Tip

- When all three IP configuration modes are ON, the priority order of the configuration mode is DHCP, AutoIP and ManualIP.
- At least one IP configuration mode should be ON.

1) DHCP

The DHCP server from the current network assigns network parameters to the multimeter such as IP address.

Press **DHCP** to turn on or off the DHCP configuration mode.

2) AutoIP

The multimeter automatically acquires an IP address from 169.254.0.1 to 169.254.255.254 and a subnet mask 255.255.0.0 according to the current network configurations.

Press **AutoIP** to turn on or off the AutoIP configuration mode. To enable this mode, **DHCP** must be OFF.

3) ManualIP

Users define the network parameters such as IP address, subnet mask and gateway.

Press **Manual** to turn on the ManualIP configuration mode and the multimeter enters the following interface. To enable this mode, neither **DHCP** nor **AutoIP** should be ON.

IPAddr				
0	.	0	.	0
0	.	0	.	0
IPAddr	Mask	Gate		↕

- **IPAddr:**

The format of IP address is nnn.nnn.nnn.nnn, for example 172.16.3.32. You are recommended to ask your network administrator for an available IP address.

Press **IPAddr** and enter the desired IP address using the direction keys.

- **Mask:**

The format of subnet mask is nnn.nnn.nnn.nnn, for example 255.255.255.0. You are recommended to ask your network administrator for an available subnet mask.

Press **Mask** and enter the desired subnet mask using the direction keys.

- **Gate:**

The format of gateway is nnn.nnn.nnn.nnn, for example 172.16.3.1. You are recommended to ask your network administrator for an available gateway.

Press **Gate** and enter the desired gateway using the direction keys.

3. To Set Domain Name Server

The format of domain name server (DNS) address is nnn.nnn.nnn.nnn, for example 202.96.199.133. You are recommended to ask your network administrator for an available address.

Press **DNS** and enter the desired address using the direction keys. Note that users generally do not need to set the domain name server address and this parameter configuration can generally be ignored.

4. To Apply Network Parameters

Press **Apply** to enable the current network parameters.

5. To Restore Factory Defaults

Press **Default** to restore the network parameters to defaults, in which the DHCP and AutoIP are ON and the ManualIP is disabled.

To Set the GPIB Address

Each device connected to the GPIB (IEEE-488.2) interface must have a unique address. Before using this interface, use GPIB cable to connect the multimeter with the PC.

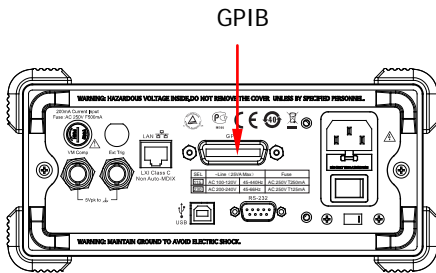

Press **Utility** → **I/O** → **GPIB** to enter the GPIB address configuration interface.

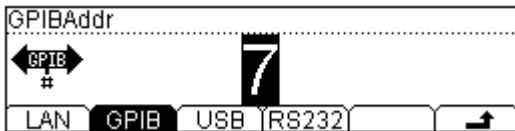

Use the direction keys to set the GPIB address to any integer within 0 and 30. The default is 7. This setting is stored in nonvolatile memory.

To Set the RS232

Before any related operations, use RS232 cable to connect the multimeter to a PC or data terminal equipment (DTE). Then, set the interface parameters such as baud rate, parity and handshake to match the multimeter with the PC or data terminal equipment, in order to control the multimeter. The measured result can be transferred into serial receiving device (PC) via this interface.

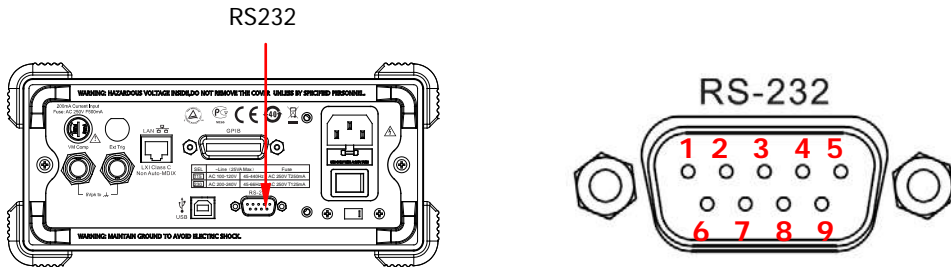

Table 2-7 RS232 Pin definition

Pin	Abbreviation	Function
1*	PASS (Carrier Detect)	Output negative pulse if P/F test succeeds
2	RXD (Receive Data)	Receive data
3	TXD (Transmit Data)	Send data
4	DTR (Data Terminal Ready)	Data terminal is ready for receiving.
5	GND (Signal Ground)	Signal Ground
6	DSR (Data Set Ready)	Data is ready.
7	RTS (Request To Send)	Unused
8	CTS (Clear To Send)	Unused
9*	FAIL (Ring Indicator)	Output negative pulse if P/F test fails

***Remark:** Pins 1 and 9 always outputs high level when P/F output is disabled.



WARNING

The P/F signal from pins 1 and 9 of RS232 is not compatible with the handshake signal (Carrier Detect and Ring Indicator) from standard RS232.

Press **Utility** → **I/O** → **RS232** to enter the following interface.

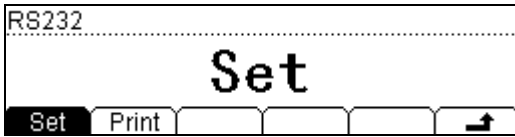

- **Set**: set RS232 interface parameters.
- **Print**: enable or disable the data output function.

1. To Set RS232 Parameters

Press **Set** to enter the following interface.

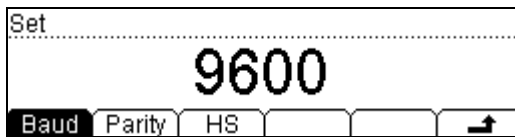

- **Baud**: select the desired baud rate from 1200, 2400, 4800, 9600, 19200, 38400, 57600 and 115200. The default is 9600. This setting is stored in nonvolatile memory.
- **Parity**: select the desired parity from None, Odd and Even. The default is None. This setting is stored in nonvolatile memory.
- **HS**: enable or disable the serial hardware handshake function. When it is disabled, please do not connect DTR/DSR pins into a logic high level.

2. Print

Press **Print** to enter the following interface, from which you can turn on or off the output of measured data from serial ports.

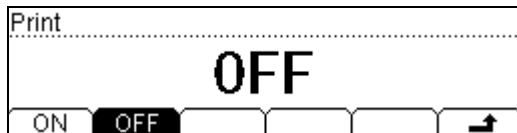

System Configuration

To Select the Language

DM3068 supports English/Chinese menus and built-in helps. All the messages, context helps and help topics are displayed in the language selected.

Press **Utility** → **System** → **Lang** to enter the following interface and choose a desired language.



To Set the Display Parameter

Press **Utility** → **System** → **Disp** to enter the following interface.

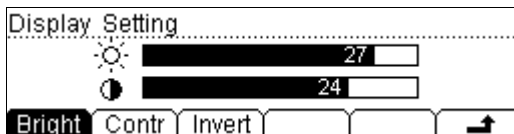

1. Bright

Press **Bright** and set an appropriate brightness within 0 and 32 using the direction keys. This setting is stored in nonvolatile memory.

2. Contr

Press **Contr** and set an appropriate contrast within 0 and 32 using the direction keys. This setting is stored in nonvolatile memory.

3. Invert

Press **Invert** to switch the screen between normal and invert display. The default is normal.

To Set the Sound

Press **Utility** → **System** → **Sound** to enter the following interface.

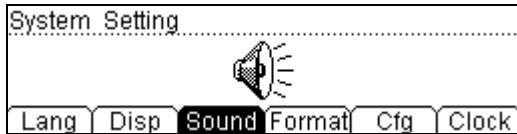

You can enable or disable the beeper for front panel key operations and short-circuit test. The setting is stored in nonvolatile memory.

To Set the Number Format

Press **Utility** → **System** → **Format** to enter the following interface.

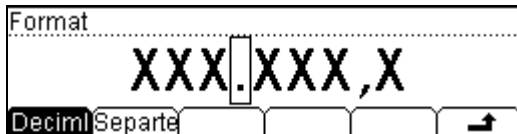

1. Deciml

Set the display format of the decimal point on the screen to "▪" or "┆".

2. Separte

Set the display format of the data separator on the screen to "┆", "None" or "Space". For example,

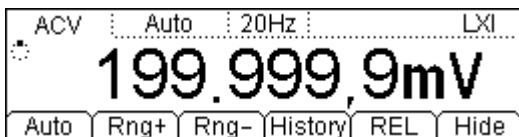

Decimal point: ▪
Separator: ┆

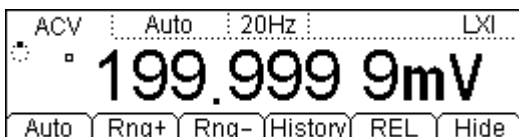

Decimal point: ▪
Separator: Space

To Set the Configuration

Press **Utility** → **System** → **Cfg** to enter the following interface.

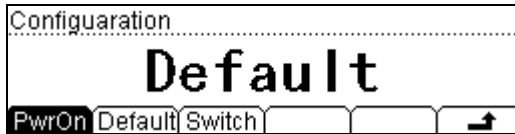

1. PwrOn

Select a system configuration to be used at power-on from “Default” and “Last” (configuration at last power-off).

- This setting will be available at the next power-on.
- The multimeter will always use DCV as the default measurement at every power-on no matter Default or Last is selected.

2. Default

Restore the multimeter to factory defaults (see Table 2-8).

3. Switch

Enable or disable the front power button. The default status is OFF.

- **ON**: enable the front power button. After turning on the power switch at the rear panel, users need to press the power button at the front panel to turn on the multimeter.
- **OFF**: disable the front power button. Users can directly start the multimeter by turning on the power switch at the rear panel. However, you can still turn off the multimeter by pressing the power button at the front panel.

Table 2-8 Factory defaults

Parameter	Factory Default
Measurement Parameters	
*Short-circuit Resistance	10 Ω
AC Filter	Mid
DC Input Impedance	10 MΩ
Reading Resolution	6 ½
Measurement Function	DCV

Range	Auto
Math Operations	
Math Status	OFF
Math Item	STA
Math Register	All registers cleared
dBm Reference Resistance	600 Ω
Trigger Parameters	
*Delay	Auto
*Number of Samples	1
*Holding Range	0.1%
*Trigger Source	Auto
System	
*Sound	ON
*Separator	,
*Language	Simplified Chinese in China and English in other area
*Display Mode	Normal (black text on white background)
Error Queue	Cleared
Saved Instrument Parameters and Data	No change
Remote Interfaces	
*GPIB Address	7
*Interface	USB
*Baud Rate	9600
*Parity Check	None (8 data bit)
*HS (Handshake)	OFF

Remark*: Parameters marked with data * in the above table are stored in nonvolatile memory.

To Set the System Clock

Press **Utility** → **System** → **Clock** to enter the following interface.

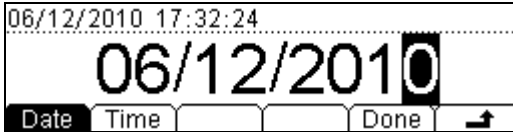

Use the left and right direction keys to move the cursor, use the up and down direction keys to modify the value and press **Done** to finish the system clock setting.

To Perform the Self-Test

DM3068 can automatically detect the system hardware and display the results in error list.

Press **Utility** → **T/C** to enter the following interface.

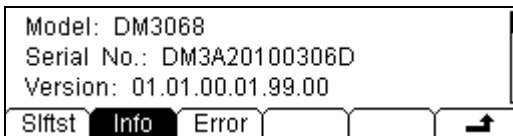

- **Siftst**: press this softkey and then press **Run** to execute the self-test.
- **Info**: provide information about the multimeter such as the model and serial number.
- **Error**: list the newest error information (up to 21 items) from the error queue.

Chapter 3 Remote Control

This chapter introduces how to control the multimeter remotely using either virtual panel based on web page or interface commands.

The chapter contains the following topics:

- Web Control
- Command Control

Web Control

DM3068 confirms to LXI-C standard and can be remotely controlled via web page. Please take the following steps.

1. Set the LAN

Connect the multimeter to LAN using network cable. Set and obtain the IP address by referring to “**Interface Configurations**” in chapter 2.

2. Execute Remote Control

Input the obtained IP address in the internet explorer and enter the following welcome interface. Then, click “Web Identification Indicator” and the beeper sounds.

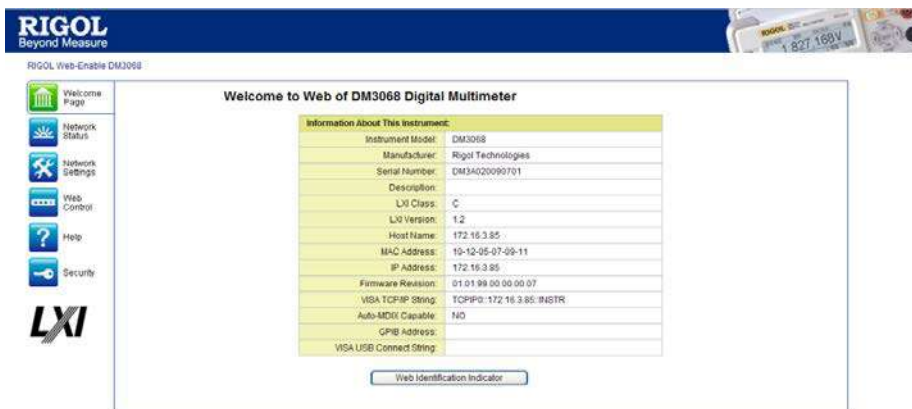

- 1) Press “Network Status” to enter the interface as shown in the figure below to view the setting information about TCP/IP and network hardware.

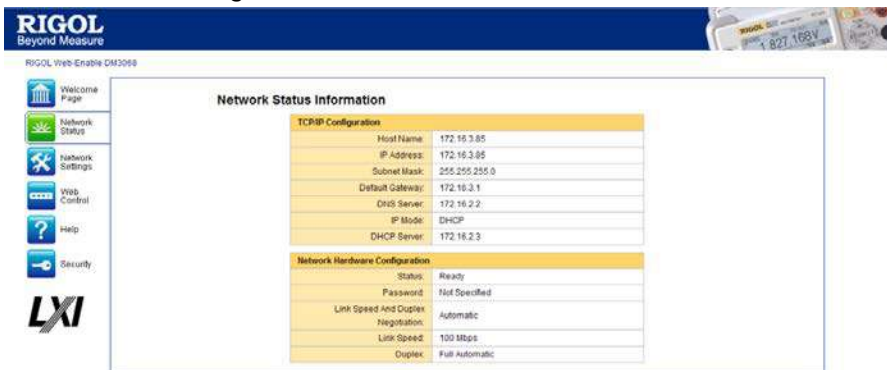

- 2) Press “Network Settings” to enter the interface as shown in the figure below.

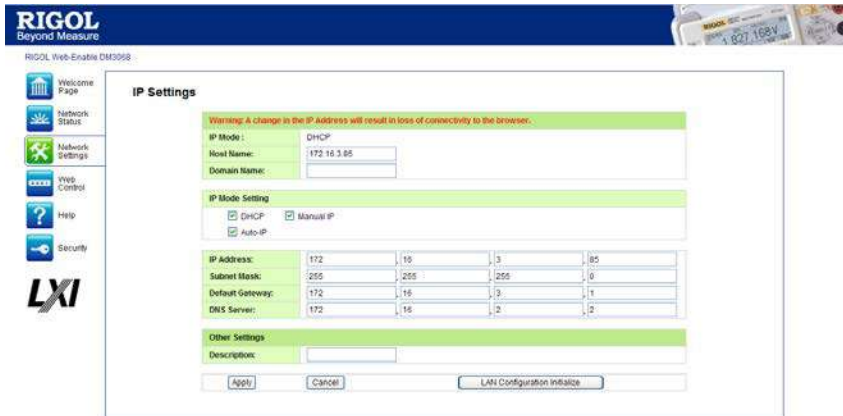

Set the IP via this interface, press “Apply” to enable the modification and press “Cancel” to disable this setting. To restore to factory setting, press “LAN Configuration Initialize”.

Explanation:

The password input box is displayed and the correct user name and password are required when using the “Network Settings” function if the multimeter has had a password set on it (the default user name and password are empty).

- 3) Press “Web Control” to enter the instrument web page control interface. At this point, you can configure the related parameters and acquire the measurement result.

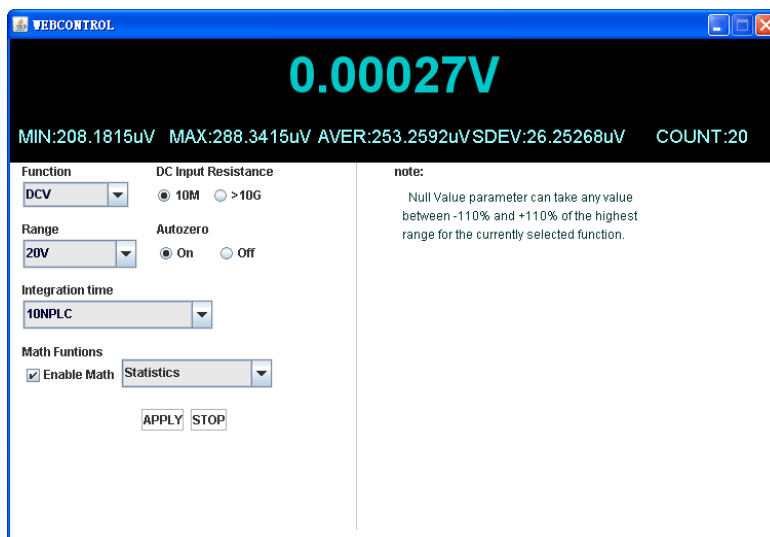

- 4) Press "Help" to enter the interface as shown in the figure below to acquire the instrument information and network setting information.

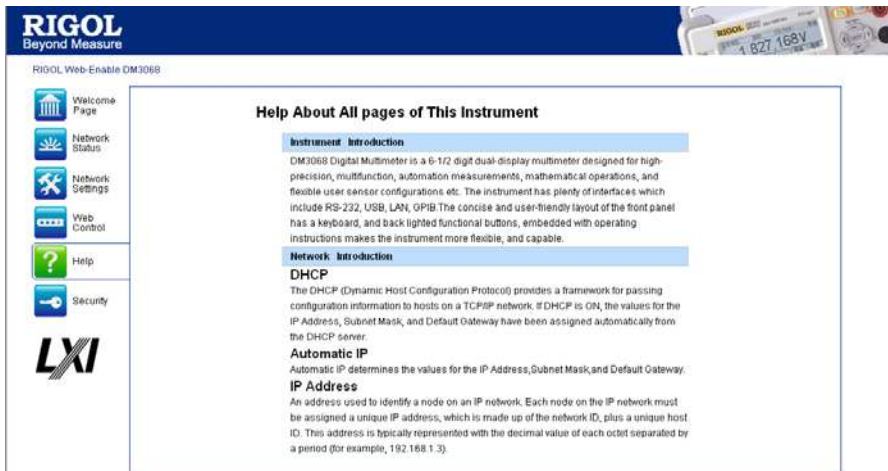

- 5) Press "Security" to enter the interface as shown in the figure below. Input the old password and then input the new password twice; press "Apply" and a message is displayed indicating that the password setting succeeds; the password modification of the network setting of network control function succeeds.

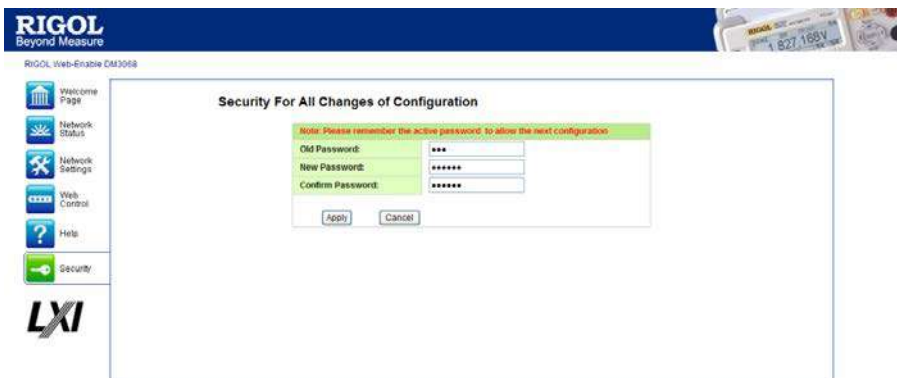

- 6) Press "LXI" to enter the official website of the LXI association (<http://www.lxistandard.org/>) to view information of the standard.

Command Control

DM3068 can be remotely controlled using commands in two ways.

User-Defined Programming

Users can program and control the multimeter using standard SCPI (Standard Commands for Programmable Instruments) commands. For more details about commands and programming, please refer to the Programming Guide of DM3068.

Use Software Offered by RIGOL or Others

Users can use **Ultra Sigma** from **RIGOL**, **Measurement & Automation Explorer** from **NI** (National Instruments Corporation) or **Agilent IO Libraries Suite** from **Agilent** (Agilent Technologies, Inc.) to send commands to control the instrument remotely.

DM3068 uses USB, LAN, RS232 or GPIB interface to communicate with PC. The next part will introduce how to control the instrument remotely using **Ultra Sigma** through various interfaces in details. To obtain the software and detailed operation methods, please contact **RIGOL** salesman or technical support.

Remote Control via USB

1. Connect the Instrument

Connect the USB Device interface of DM3068 to the PC USB Host interface using USB cable.

2. Install the USB Driver

DM3068 is a USBTMC device. After you connect the instrument to the PC and turn both on (the instrument is automatically configured to USB interface), the **New Hardware Wizard** is displayed on the PC. Please install the “USB Test and Measurement Device” driver following the directions in the wizard.

3. Search USB Devices

Turn on the Ultra Sigma, the software automatically searches instruments connected to the PC. Additionally, you can click  to search the resources. During the search, the status bar of the software is as shown in the figure below.



4. View USB Device

The searched instruments are shown under the “RIGOL Online Resource” directory with the model and USB interface information, as shown in the figure below.

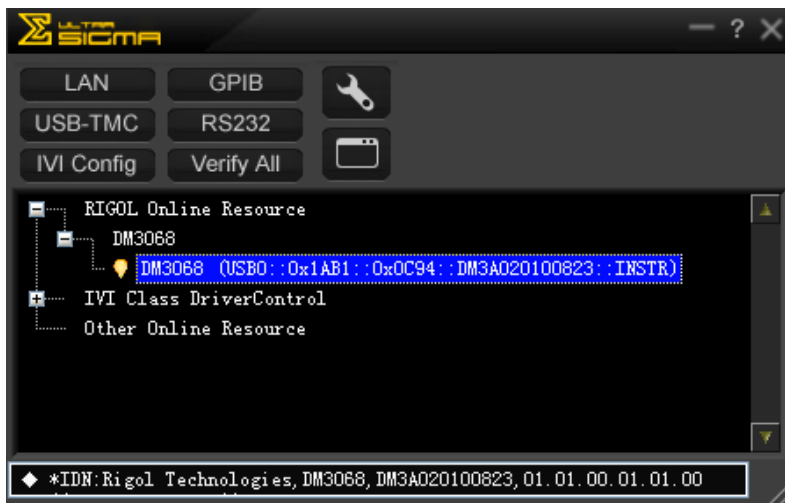

5. Communication Test

Right click the source name

“DM3068 (USB0::0x1AB1::0x0C94::DM3A020100823::INSTR)” and then select “SCPI Panel Control” to open the remote command control panel, from which you can send commands and read data as shown in the figure below.

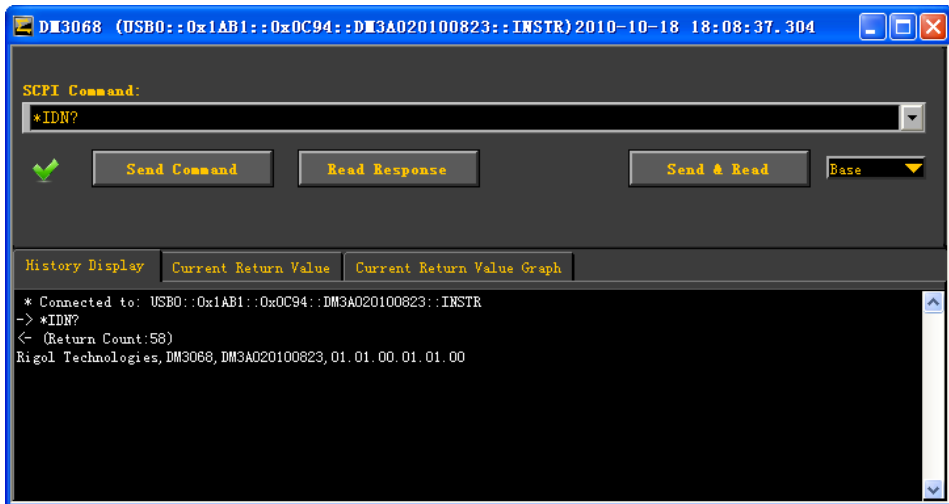

Remote Control via LAN

1. Connect the Instrument

Connect the multimeter to you local network using network cable.

2. Configure LAN Parameters

Select LAN interface and configure its parameters according to “**Interface Configurations**” in chapter 2.

3. Search LAN Device

Turn on the Ultra Sigma and click . Click “Search” in the pop-up window and the software searches for the instrument resources currently connected to the LAN and the resources found are displayed at the right of the window. Select the desired resource name and click “OK” to add it as shown in the figure below.

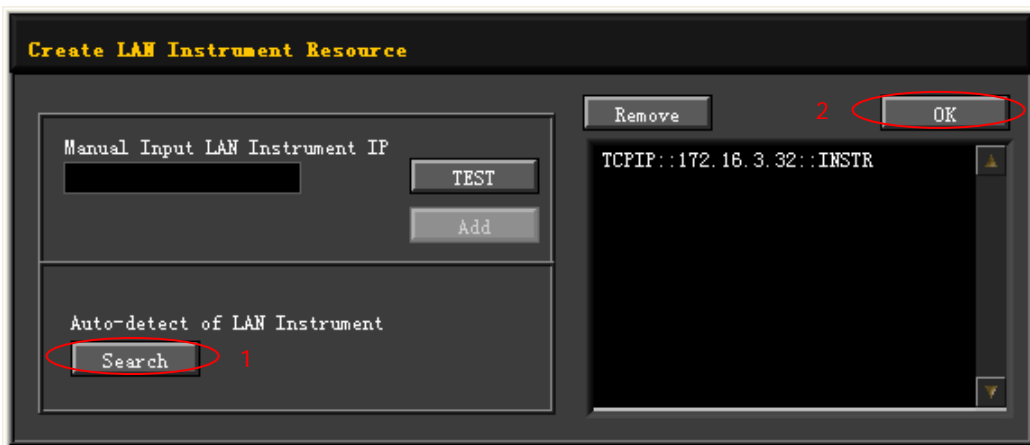

4. View LAN Device

The searched instruments are shown under the “RIGOL Online Resource” directory, as shown in the figure below.

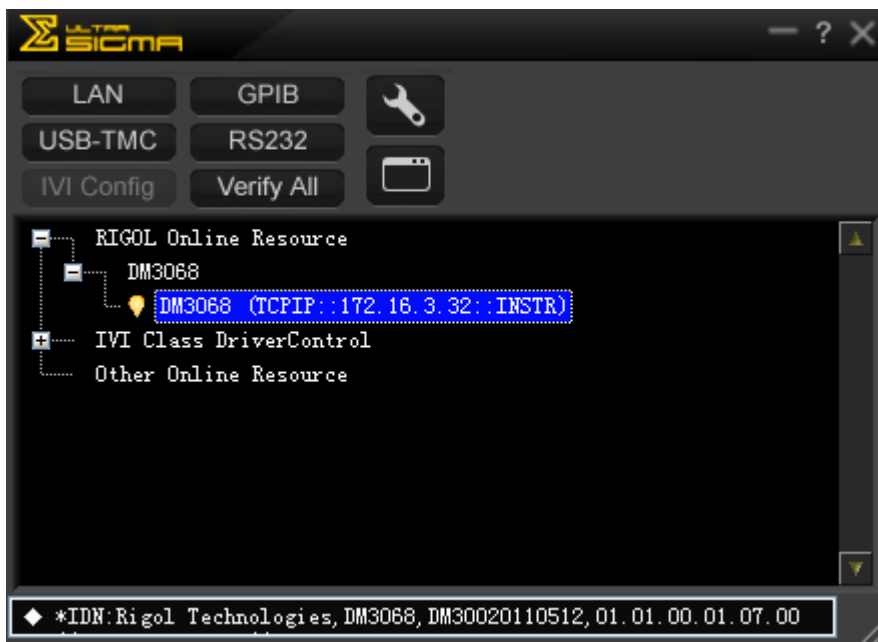

5. Communication Test

Right click the source name “DM3068 (TCPIP::172.16.3.32::INSTR)” and then select “SCPI Panel Control” to open the remote command control panel, from which you can send commands and read data as shown in the figure below.

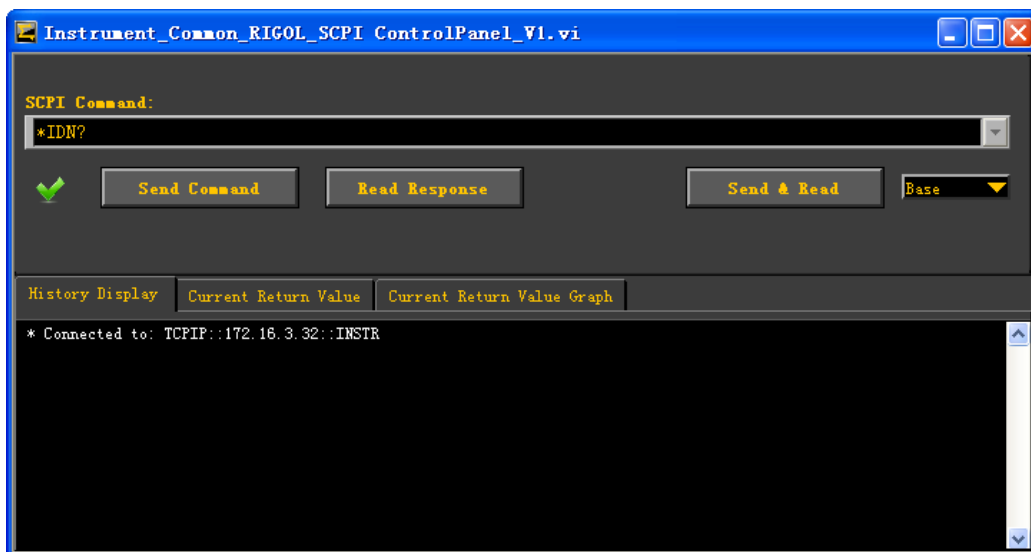

6. Load LXI Web Page

As the instrument conforms to LXI-C standards, you can load LXI web page through Ultra Sigma (right-click the resource name and select LXI-Web). Various important information about the instrument (including the model number, manufacturer, serial number, description, MAC address and IP address) will be displayed on the webpage. Please refer to “**Web Page Control**”.

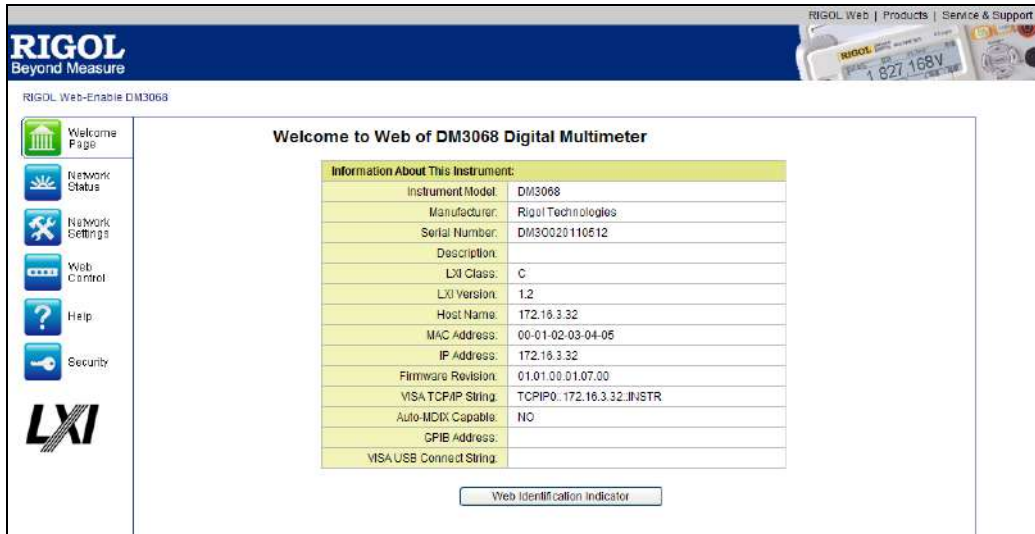

Remote Control via GPIB

1. Connect the Instrument

Connect the multimeter to PC using GPIB cable.

2. Configure GPIB Address

Select GPIB interface and configure its address according to “**Interface Configurations**” in chapter 2.

3. Search RS232 Devices

Turn on the Ultra Sigma and click  to enter the communication setting interface as shown in the figure below. Click “Search” and the software will search the GPIB instrument resources connected to the PC. The device resources will be displayed on the right side of the panel.



If resources can not be found automatically:

- Select the GPIB card address of the PC from the comboBox of “GPIB::” and select the GPIB address set in the instrument from the comboBox of “::INSTR”.
- Click “Test” to check whether the GPIB communication works normally; if not, please follow the corresponding prompt messages to solve the problem.

4. View GPIB Device

Click “OK” and the software return to its main interface. The searched instruments are shown under the “RIGOL Online Resource” directory, as

shown in the figure below.

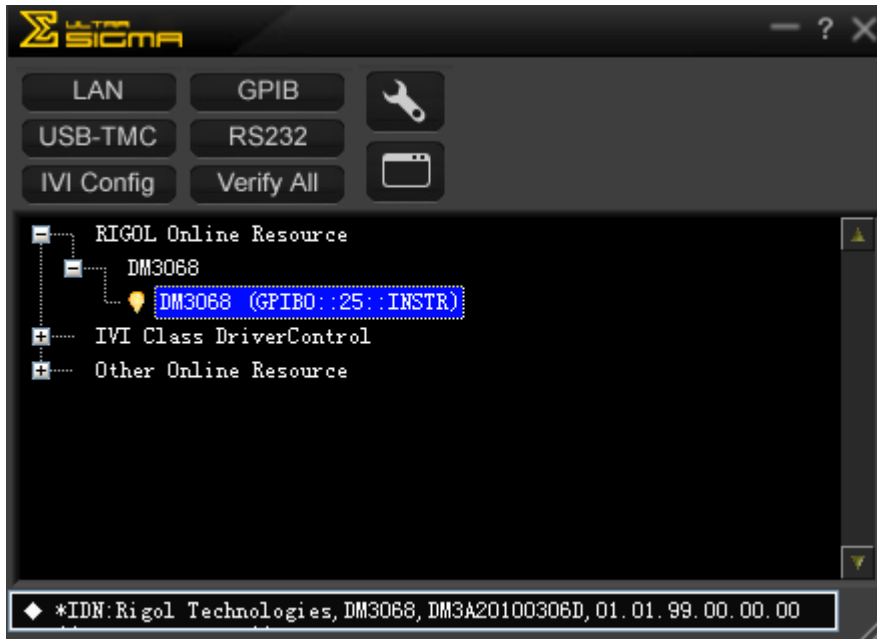

5. Communication Test

Right click the source name “DM3068 (GPIB0::25::INSTR)” and then select “SCPI Panel Control” to open the remote command control panel, from which you can send commands and read data as shown in the figure below.

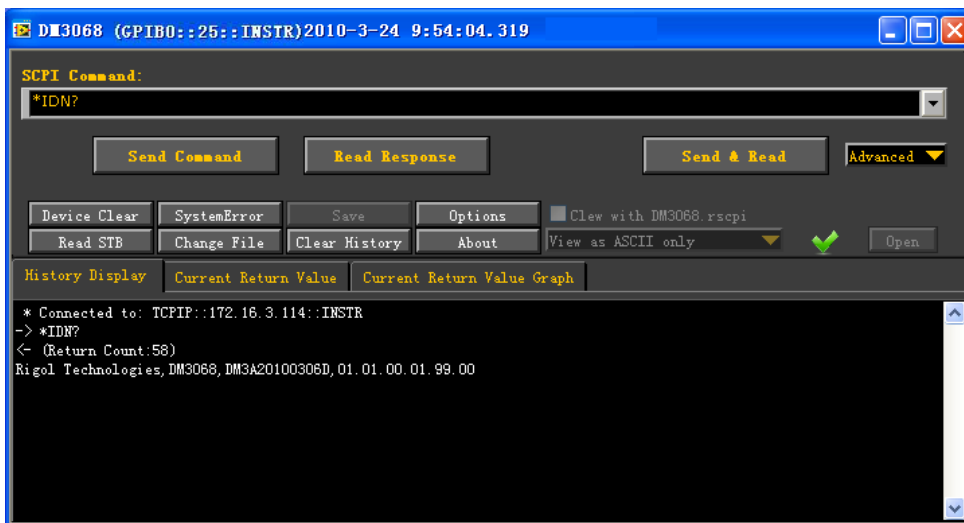

Remote Control via RS232



1. Instrument Connection

Connect the multimeter to PC using RS232 cable.

2. Configure RS232 Parameters

Select RS232 interface and configure its parameters according to “**Interface Configurations**” in chapter 2.

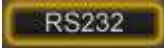
3. Search RS232 Device

Turn on the Ultra Sigma and click  to enter the communication setting interface shown below. After you configure parameters according to the instrument serial port parameters (“\r\n” must be selected in End Mark), click  to test the RS232 communication. When the communication succeeds, the searched devices are shown in resource list at the right side of the panel; otherwise, follow the guides to solve the problem.

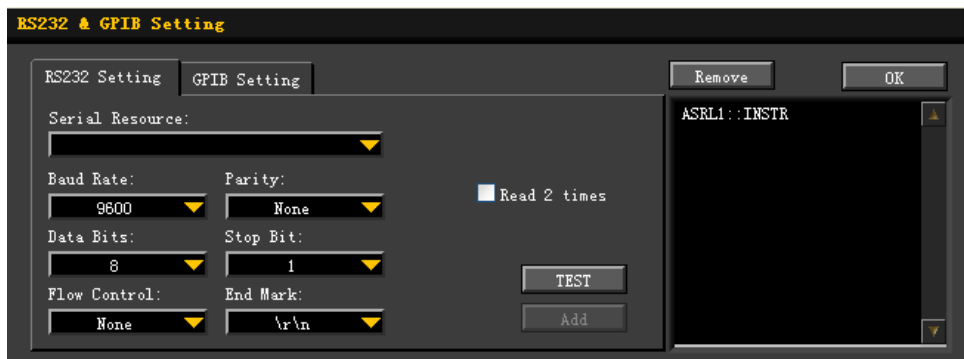

4. View RS232 Device

Click “OK”, the software returns to the main interface and the searched instruments are shown under the “RIGOL Online Resource” directory as shown in the figure below.

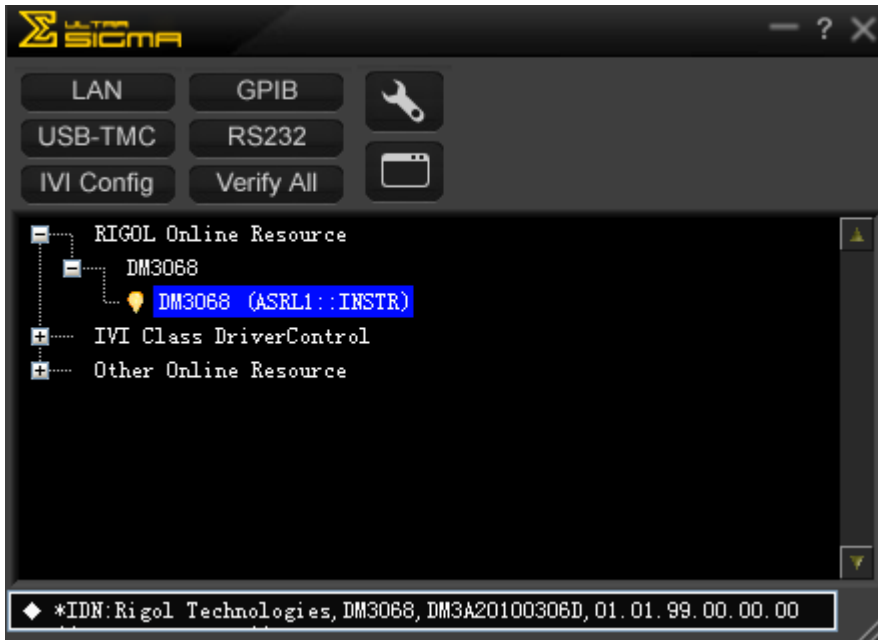

5. Communication Test

Right click the source name “DM3068 (ASRL1::INSTR)” and then choose “SCPI Panel Control” to open the remote command control panel, from which you can send commands and read data as shown in the figure below.

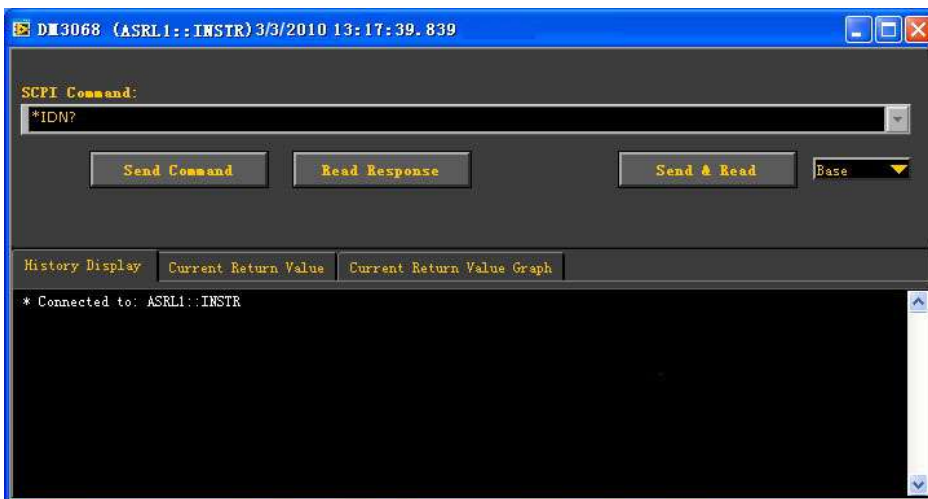

Chapter 4 Troubleshooting

The commonly encountered failures and their solutions are listed below. When you encounter those problems, please solve them following the corresponding steps. If the problem remains still, please contact **RIGOL** and provide your device information (Utility → T/C → Info).

- 1. The screen is still dark (no display) after power on.**
 - 1) Check whether the power cord is well connected.
 - 2) Check whether the power switch on the rear panel is switched on.
 - 3) Check whether the fuse is burned out. If the fuse needs to be changed, please use the specified fuse.
 - 4) Restart the instrument after finishing the above inspections.
 - 5) If the problem persists, please contact **RIGOL**.

- 2. The reading does not change when a current signal is input.**
 - 1) Check whether the test lead is correctly inserted into the HI and LO terminals of current measurement.
 - 2) Check whether the current fuse at the rear panel is burned out.
 - 3) Check whether the DCI or ACI measurement function is enabled.
 - 4) Check whether the DCI measurement function is used to measure AC current.

- 3. The reading is abnormal when a DC signal is input.**
 - 1) Check whether the test lead is correctly inserted into the HI and LO terminals of current measurement.
 - 2) Check whether the current fuse at the rear panel is burned out.
 - 3) Check whether the DCI or DCV measurement function is enabled.
 - 4) Check whether the ACI measurement function is used to measure DC current.

- 4. The USB storage device cannot be identified.**
 - 1) Check whether the USB storage device is in good condition.
 - 2) Make sure the USB storage device you used is a flash storage device. This instrument does not support hardware storage type.
 - 3) Check the capacity of your USB storage device. It is recommended that

the capacity of the USB storage device is no larger than 4G bytes.

- 4) Restart the multimeter and insert the USB storage device.
- 5) If the problem persists, please contact **RIGOL**.

Chapter 5 Measurement Tutorial

This chapter introduces how to eliminate the potential error during your measurement in order to obtain accurate measurement result.

The chapter contains the following topics:

- Loading Errors (DCV)
- True-RMS AC Measurements
- Crest Factor Errors (non-sinusoidal inputs)
- Loading Errors (ACV)

Loading Errors (DCV)

Measurement loading errors occur when the resistance of the device-under-test (DUT) takes up a certain percentage in the multimeter's own input resistance. The diagram below shows this error source.

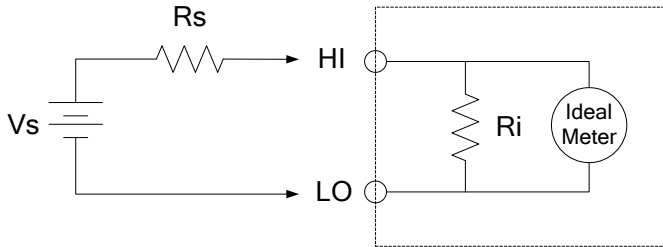

V_s = ideal DUT voltage

R_s = DUT source resistance

R_i = input resistance of the multimeter (10 M Ω or >10 G Ω)

$$\text{Error (\%)} = \frac{100 \times R_s}{R_s + R_i}$$

To reduce the effect of loading errors and noise interference, you can set the input resistance of the multimeter to ">10G Ω " for 200 mV, 2 V and 20 V ranges, and "10M Ω " for the 200 V and 1000 V ranges.

True-RMS AC Measurements

The AC measurement of DM3068 has true RMS response. The average thermal power of the resistor over a certain period is directly proportional to the square of the true RMS of the voltage of the resistor over this period of time, regardless of the waveform shape. DM3068 can accurately measure the true RMS voltage or current if the energy of the voltage or current waveform outside the effective bandwidth of the multimeter can be ignored. The effective AC voltage bandwidth of DM3068 is 800 kHz and the effective AC current bandwidth is 100 kHz.

The multimeter's ACV and ACI functions measure the "AC coupled" true RMS value, namely the RMS value of the AC component (the DC component is filtered out) of the input signal. As shown in table 5-1, since the sine, triangle and square (50% duty cycle) waves do not have DC offset, their AC true RMS values equal the AC+DC true RMS values.

Table 5-1 True- RMS AC Measurements of Sine, Triangle and Square waves

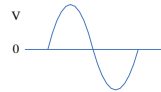
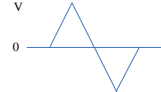
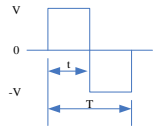
Waveform	Crest Factor (C.F.)	AC RMS	AC+DC RMS
	$\sqrt{2}$	$\frac{V}{\sqrt{2}}$	$\frac{V}{\sqrt{2}}$
	$\sqrt{3}$	$\frac{V}{\sqrt{3}}$	$\frac{V}{\sqrt{3}}$
	1	$\frac{V}{C.F.}$	$\frac{V}{C.F.}$

Unsymmetrical waveforms such as pulse sequence contain DC component which will be filtered out during the AC coupled true RMS measurements.

The AC coupled true RMS measurement is especially useful for measuring small AC signals having DC offset such as the AC ripple from DC power supplies. However, in some cases you need to measure the AC+DC true RMS value. First you can

measure the DC and AC components of the signal using DCV and ACV measurements, and then calculate the AC+DC true RMS value according to the formula below. In order to obtain the best AC rejection, select 6.5 digits when measuring DC voltage.

$$RMS_{(AC+DC)} = \sqrt{AC^2 + DC^2}$$

Crest Factor Errors (non-sinusoidal inputs)

A common misconception is that "since a multimeter can measure the true RMS of signal, its sine wave accuracy specifications apply to all waveforms." Actually, the waveform shape of the input signal can affect the measurement accuracy. A common way to describe the signal wave shape is "crest factor". Crest factor is the ratio of the peak value to RMS value of a waveform.

In general, the greater the crest factor is, the greater the energy contained in high frequency harmonics will be. All multimeters have errors that are relevant to the crest factor. Crest factor errors of DM3068 are listed in "**AC Characteristics**" in chapter 6.

You can estimate the measurement error due to signal crest factor according to the equation below.

Total Error = Error (Sine wave) + Error (Crest factor) + Error (Bandwidth)

Error (Sine wave): sine wave error as shown in chapter 6.

Error (Crest factor): additional crest factor error as shown in chapter 6.

Error (Bandwidth): bandwidth error can be estimated according to the formula below.

$$\text{Bandwidth Error} = \frac{-C.F.^2 \times F}{4\pi \times BW} \times 100\% \quad (\% \text{ reading})$$

$C.F.$: signal crest factor

F : pulse fundamental wave frequency

BW : multimeter's effective bandwidth

Example:

Calculate the approximate measurement error for a pulse train with a crest factor of 2 and a fundamental frequency of 20 kHz. Assume that the multimeter's 1-year accuracy is $\pm (0.05\% \times \text{reading} + 0.03\% \times \text{range})$.

$$\begin{aligned} \text{Total Error} &= (0.05\% \times \text{reading} + 0.03\% \times \text{range}) + (0.05\% \times \text{range}) + \\ &(0.8\% \times \text{reading}) = 0.85\% \times \text{reading} + 0.08\% \times \text{range} \end{aligned}$$

Loading Errors (ACV)

In the AC Voltage function, the input impedance of DM3068 appears as a 1 M Ω resistance in parallel with 100 pF of capacitance. The test lead of the multimeter will also add additional capacitance and load.

The table below gives the multimeter's approximate input resistance at various frequencies.

Table 5-2 Resistances at various frequencies

Input Frequency	Input Resistance
100 Hz	1 M Ω
1 kHz	850 k Ω
10 kHz	160 k Ω
100 kHz	16 k Ω

For low frequencies:

$$\text{Loading Error (\%)} = \frac{-R_s}{R_s + 1M\Omega} \times 100\%$$

Additional error for high frequencies:

$$\text{Loading Error (\%)} = \left[\frac{1}{\sqrt{1 + (2\pi \times F \times R_s \times C_{in})^2}} - 1 \right] \times 100\%$$

R_s : internal resistance of the signal generator

F : input frequency

C_{in} : input capacitance (100 pF) plus test lead capacitance

Chapter 6 Specifications

DC Characteristics

Accuracy Specifications: \pm (% of reading + % of range)^[1]

Function	Range ^[2]	Test Current or Load Voltage	24 Hour ^[3] T _{CAL} °C ±1°C	90 Day T _{CAL} °C ±5°C	1 Year T _{CAL} °C ±5°C	Temperature Coefficient 0°C to (T _{CAL} °C -5°C) (T _{CAL} °C +5°C) to 50°C
DC Voltage	200.0000 mV		0.0020 + 0.0020	0.0030 + 0.0025	0.0040 + 0.0025	0.0005 + 0.0005
	2.000000 V		0.0015 + 0.0005	0.0020 + 0.0006	0.0035 + 0.0006	0.0005 + 0.0001
	20.00000 V		0.0020 + 0.0004	0.0030 + 0.0005	0.0040 + 0.0005	0.0005 + 0.0001
	200.0000 V		0.0020 + 0.0006	0.0040 + 0.0006	0.0050 + 0.0006	0.0005 + 0.0001
	1000.000 V ^[4]		0.0020 + 0.0006	0.0040 + 0.0010	0.0055 + 0.0010	0.0005 + 0.0001
DC Current	200.0000 uA	<0.03 V	0.010 + 0.012	0.040 + 0.015	0.050 + 0.015	0.0020 + 0.0030
	2.000000 mA	<0.25 V	0.007 + 0.003	0.030 + 0.003	0.050 + 0.003	0.0020 + 0.0005
	20.00000 mA	<0.07 V	0.007 + 0.012	0.030 + 0.015	0.050 + 0.015	0.0020 + 0.0020
	200.0000 mA	<0.7 V	0.010 + 0.002	0.030 + 0.003	0.050 + 0.003	0.0020 + 0.0005
	2.000000 A	<0.12 V	0.050 + 0.020	0.080 + 0.020	0.100 + 0.020	0.0050 + 0.0010
	10.00000 A ^[5]	<0.6 V	0.100 + 0.010	0.120 + 0.010	0.150 + 0.010	0.0050 + 0.0020
Resistance ^[6]	200.0000 Ω	1 mA	0.0030 + 0.0030	0.008 + 0.004	0.010 + 0.004	0.0006 + 0.0005
	2.000000 kΩ	1 mA	0.0020 + 0.0005	0.008 + 0.001	0.010 + 0.001	0.0006 + 0.0001
	20.00000 kΩ	100 uA	0.0020 + 0.0005	0.008 + 0.001	0.010 + 0.001	0.0006 + 0.0001
	200.0000 kΩ	10 uA	0.0020 + 0.0005	0.008 + 0.001	0.010 + 0.001	0.0006 + 0.0001
	1.000000 MΩ	2 uA	0.002 + 0.001	0.010 + 0.001	0.012 + 0.001	0.0010 + 0.0002
	10.00000 MΩ	200 nA	0.015 + 0.001	0.030 + 0.001	0.040 + 0.001	0.0030 + 0.0004

	100.0000 M Ω	200 nA 10 M Ω	0.300 + 0.010	0.800 + 0.010	0.800 + 0.010	0.1500 + 0.0002
Diode Test	2.0000 V ^[7]	1 mA	0.002 + 0.010	0.008 + 0.020	0.010 + 0.020	0.0010 + 0.0020
Continuity Test	2000.0 Ω	1 mA	0.002 + 0.010	0.008 + 0.020	0.010 + 0.020	0.0010 + 0.0020

- [1] Specifications are for 90-minute warm-up and 100 PLC integration time. When the integration time is <100 PLC, add the appropriate “**RMS Noise Adder**” listed in the following table.
- [2] 10% overrange on all ranges except DCV 1000 V and DCI 10 A ranges.
- [3] Relative to calibration standards.
- [4] For each additional volt over ± 500 V, add 0.03 mV error.
- [5] For continuous current > 7A DC or 7A AC rms, 30 seconds ON and 30 seconds OFF.
- [6] Specifications are for 4–wire resistance measurement or 2–wire resistance measurement using REL operation. Without REL operation, add 0.2 Ω additional error in 2-wire resistance measurement.
- [7] Accuracy specifications for the voltage measured at the input terminal only. 1 mA test current is typical. Variation in the current source will cause some variation in the voltage drop across a diode junction.

Performance of Different Integration Time – 50 Hz (60 Hz) Power-line Frequency

Integration Time Number of Power Line Cycles (NPLC)	Resolution ^[1] (ppm Range)	NMRR ^[2] (dB)	Readings/s ^[3]		RMS Noise Adder ^[4] (% of Range)			
			50 Hz	60 Hz	DCV 20 V	DCV 2 V 200 V Resistance 2 k Ω 20 k Ω	DCV 1000 V DCI 2 mA 200 mA	DCV 200 mV Resistance 200 Ω DCI 10 A
0.006	2.7	0	10000	10000	0.0006	0.0007	0.0015	0.0040
0.02	1.6	0	2500	3000	0.0004	0.0004	0.0008	0.0025
0.06	1	0	833	1000	0.0003	0.0003	0.0006	0.0025
0.2	0.5	0	250	300	0.0001	0.0002	0.0003	0.0015
1	0.22	60	50	60	0	0.0001	0.0002	0.0004
2	0.17	60	25	30	0	0	0.0001	0.0003
10	0.08	60	5	6	0	0	0	0.0002
100	0.035	60	0.5	0.6	0	0	0	0

- [1] Typical value. Resolution is defined as the RMS noise of DCV 20 V range (set auto zero to "Once").
- [2] Normal mode rejection ratio for power frequency $\pm 0.1\%$. For power-line frequency $\pm 1\%$, subtract 20 dB. For $\pm 3\%$, subtract 30 dB.
- [3] Maximum rate for DCV, DCI, 2-wire resistance and 4-wire resistance functions.
- [4] The basic DC accuracy specifications include RMS noise at 100 PLC. For < 100 PLC, add "**RMS Noise Adder**" to the basic DC accuracy specifications.

SFDR & SINAD^[1]

Function	Range	Spurious-Free Dynamic Range (SFDR)	Signal-to-Noise-and-Distortion (SINAD)
DCV	200 mV	81	76
	2 V	79	78
	20 V	79	75
	200 V	83	80
	1000 V	86	82
DCI	200 μ A	89	69
	2 mA	86	81
	20 mA	88	69
	200 mA	81	79
	2 A	69	64

- [1] Typical value. -1 dBFS, 1kHz single tone. 100 μ s aperture time, zero trigger delay, auto zero off and 4096 samples.

Measuring Characteristics

DC Voltage	
Input Impedance	200 mV, 2 V, 20 V ranges: 10 M Ω or >10 G Ω (For these ranges, input beyond ± 26 V are clamped through 106 k Ω)
	200 V and 1000 V ranges: 10 M Ω $\pm 1\%$
Input Protection	1000 V
Input Offset Current	50 pA, at 25°C, typical
CMRR (common mode rejection ratio)	140 dB for 1 k Ω unbalanced resistance in LO lead, ± 500 VDC peak maximum.
Resistance	
Measurement Method	4-wire or 2-wire resistance Current source referenced to LO input
Open-circuit Voltage	Limited to <10 V
Max. Lead Resistance (4-wire)	10% of range per lead for 200 Ω and 2 k Ω ranges, 1 k Ω per lead on all other ranges
Input Protection	1000 V on all ranges
Offset Compensation	Available on 200 Ω , 2 k Ω and 20 k Ω ranges.
DC Current	
Shunt Resistor	100 Ω for 200 μ A, 2 mA
	1 Ω for 20 mA, 200 mA
	0.01 Ω for 2 A, 10 A
Input Protection	Externally accessible 500 mA, 250 V high speed fuse at the rear panel for 200 μ A, 2 mA, 20 mA and 200 mA ranges. Internal 10 A, 250 V high speed fuse for 2 A and 10 A ranges.

Continuity/Diode Test	
Response Time	300 samples/sec, with audible tone
Continuity Threshold	Adjustable from 1 Ω to 2000 Ω
Auto Zero OFF Operation (typical value)	
Following instrument warm-up at the environment temperature $\pm 1^{\circ}\text{C}$ and <5 minutes, add 0.0001 % range + 2 μV error for DCV and 2 $\text{m}\Omega$ error for resistance.	
Settling Considerations	
Reading settling times are affected by source impedance, cable dielectric characteristics and input signal changes. The default measurement delay can ensure the correctness of the first reading for most measurements.	
Measurement Considerations	
Teflon or other high-impedance, low-dielectric absorption wire insulation is recommended for these measurements.	

AC Characteristics

Accuracy Specifications: \pm (% of reading + % of range)^[1]

Function	Range ^[2]	Frequency Range	24 Hour ^[3] $T_{CAL} \text{ } ^\circ\text{C} \pm 1^\circ\text{C}$	90 Day $T_{CAL} \text{ } ^\circ\text{C} \pm 5^\circ\text{C}$	1 Year $T_{CAL} \text{ } ^\circ\text{C} \pm 5^\circ\text{C}$	Temperature Coefficient 0°C to ($T_{CAL} \text{ } ^\circ\text{C} - 5^\circ\text{C}$) ($T_{CAL} \text{ } ^\circ\text{C} + 5^\circ\text{C}$) to 50°C
True RMS AC Voltage ^[4]	200.0000 mV	3 Hz- 5 Hz	1.00 + 0.03	1.00 + 0.04	1.00 + 0.04	0.100 + 0.004
		5 Hz-10 Hz	0.35 + 0.03	0.35 + 0.04	0.35 + 0.04	0.035 + 0.004
		10 Hz-20 kHz	0.04 + 0.03	0.05 + 0.04	0.06 + 0.04	0.005 + 0.004
		20 kHz-50 kHz	0.10 + 0.05	0.11 + 0.05	0.12 + 0.05	0.011 + 0.005
		50 kHz-100 kHz	0.55 + 0.08	0.60 + 0.08	0.60 + 0.08	0.060 + 0.008
		100 kHz- 300 kHz	4.00 + 0.50	4.00 + 0.50	4.00 + 0.50	0.20 + 0.02
	2.000000 V	3 Hz-5 Hz	1.00 + 0.02	1.00 + 0.03	1.00 + 0.03	0.100 + 0.003
		5 Hz-10 Hz	0.35 + 0.02	0.35 + 0.03	0.35 + 0.03	0.035 + 0.003
		10 Hz-20 kHz	0.04 + 0.02	0.05 + 0.03	0.06 + 0.03	0.005 + 0.003
		20 kHz-50 kHz	0.10 + 0.04	0.11 + 0.05	0.12 + 0.05	0.011 + 0.005
		50 kHz-100 kHz	0.55 + 0.08	0.60 + 0.08	0.60 + 0.08	0.060 + 0.008
		100 kHz – 300 kHz	4.00 + 0.50	4.00 + 0.50	4.00 + 0.50	0.20 + 0.02
	20.00000 V	3 Hz-5 Hz	1.00 + 0.03	1.00 + 0.04	1.00 + 0.04	0.100 + 0.004
		5 Hz-10 Hz	0.35 + 0.03	0.35 + 0.04	0.35 + 0.04	0.035 + 0.004
		10 Hz-20 kHz	0.04 + 0.04	0.07 + 0.04	0.08 + 0.04	0.008 + 0.004
		20 kHz- 50 kHz	0.10 + 0.05	0.12 + 0.05	0.15 + 0.05	0.012 + 0.005
		50 kHz-100 kHz	0.55 + 0.08	0.60 + 0.08	0.60 + 0.08	0.060 + 0.008
		100 kHz-300 kHz	4.00 + 0.50	4.00 + 0.50	4.00 + 0.50	0.20 + 0.02
	200.0000 V	3 Hz-5 Hz	1.00 + 0.02	1.00 + 0.03	1.00 + 0.03	0.100 + 0.003
		5 Hz-10 Hz	0.35 + 0.02	0.35 + 0.03	0.35 + 0.03	0.035 + 0.003
		10 Hz-20 kHz	0.04 + 0.02	0.07 + 0.03	0.08 + 0.03	0.008 + 0.003

		20 kHz-50 kHz	0.10 + 0.04	0.12 + 0.05	0.15 + 0.05	0.012 + 0.005
		50 kHz-100 kHz	0.55 + 0.08	0.60 + 0.08	0.60 + 0.08	0.060 + 0.008
		100 kHz-300 kHz	4.0 + 0.50	4.0 + 0.50	4.0 + 0.50	0.20 + 0.02
	750.000 V ^[5]	3 Hz-5 Hz	1.00 + 0.02	1.00 + 0.03	1.00 + 0.03	0.100 + 0.003
		5 Hz-10 Hz	0.35 + 0.02	0.35 + 0.03	0.35 + 0.03	0.035 + 0.003
		10 Hz-20 kHz	0.04 + 0.02	0.07 + 0.03	0.08 + 0.03	0.008 + 0.003
		20 kHz-50 kHz	0.10 + 0.04	0.12 + 0.05	0.15 + 0.05	0.012 + 0.005
		50 kHz-100 kHz	0.55 + 0.08	0.60 + 0.08	0.60 + 0.08	0.060 + 0.008
		100 kHz-300 kHz	4.0 + 0.50	4.0 + 0.50	4.0 + 0.50	0.20 + 0.02
		True RMS AC Current ^[8]	200.0000 uA	3 Hz-5 Hz	1.10 + 0.06	1.10 + 0.06
5 Hz-10 Hz	0.35 + 0.06			0.35 + 0.06	0.35 + 0.06	0.100 + 0.006
10 Hz-5 kHz	0.15 + 0.06			0.15 + 0.06	0.15 + 0.06	0.015 + 0.006
5 kHz-10 kHz	0.35 + 0.70			0.35 + 0.70	0.35 + 0.70	0.030 + 0.006
2.000000 mA	3 Hz-5 Hz		1.00 + 0.04	1.00 + 0.04	1.00 + 0.04	0.100 + 0.006
	5 Hz-10 Hz		0.30 + 0.04	0.30 + 0.04	0.30 + 0.04	0.035 + 0.006
	10 Hz-5 kHz		0.12 + 0.04	0.12 + 0.04	0.12 + 0.04	0.015 + 0.006
	5 kHz-10 kHz		0.20 + 0.25	0.20 + 0.25	0.20 + 0.25	0.030 + 0.006
20.00000 mA	3 Hz-5 Hz		1.10 + 0.06	1.10 + 0.06	1.10 + 0.06	0.200 + 0.006
	5 Hz-10 Hz		0.35 + 0.06	0.35 + 0.06	0.35 + 0.06	0.100 + 0.006
	10 Hz-5 kHz		0.15 + 0.06	0.15 + 0.06	0.15 + 0.06	0.015 + 0.006
	5 kHz-10 kHz		0.35 + 0.70	0.35 + 0.70	0.35 + 0.70	0.030 + 0.006
200.0000 mA	3 Hz-5 Hz		1.00 + 0.04	1.00 + 0.04	1.00 + 0.04	0.100 + 0.006
	5 Hz-10 Hz		0.30 + 0.04	0.30 + 0.04	0.30 + 0.04	0.035 + 0.006
	10 Hz-5 kHz		0.10 + 0.04	0.10 + 0.04	0.10 + 0.04	0.015 + 0.006
	5 kHz-10 kHz		0.20 + 0.25	0.20 + 0.25	0.20 + 0.25	0.030 + 0.006
2.000000 A	3 Hz-5 Hz		1.10 + 0.06	1.10 + 0.06	1.10 + 0.06	0.100 + 0.006
	5 Hz-10 Hz		0.35 + 0.06	0.35 + 0.06	0.35 + 0.06	0.035 + 0.006
	10 Hz-5 kHz		0.15 + 0.06	0.15 + 0.06	0.15 + 0.06	0.015 + 0.006
	5 kHz-10 kHz		0.35 + 0.70	0.35 + 0.70	0.35 + 0.70	0.030 + 0.006

	10.00000 A ^[6]	3 Hz-5 Hz	1.10 + 0.08	1.10 + 0.10	1.10 + 0.10	0.100 + 0.008
		5 Hz-10 Hz	0.35 + 0.08	0.35 + 0.10	0.35 + 0.10	0.035 + 0.008
		10 Hz-5 kHz	0.15 + 0.08	0.15 + 0.10	0.15 + 0.10	0.015 + 0.008

Additional Low Frequency Errors (% of reading)				Additional Crest Factor Errors (non-sine wave) ^[7]	
Frequency	AC Filter			Crest Factor	Error (% of reading)
	Slow	Medium	Fast		
10 Hz-20 Hz	0	0.74	--	1 - 2	0.05
20 Hz-40 Hz	0	0.22	--	2 - 3	0.2
40 Hz-100 Hz	0	0.06	0.73	3 - 4	0.4
100 Hz- 200 Hz	0	0.01	0.22	4 - 5	0.5
200 Hz-1 kHz	0	0	0.18		
>1 kHz	0	0	0		

[1] Specifications are for 90-minute warm-up, slow ac filter and sinewave input.

[2] 10% overrange on all ranges except ACV 750 V and ACI 10 A ranges.

[3] Relative to calibration standards.

[4] Specifications are for sinewave input >5% of range. For inputs from 1% to 5% of range and <50 kHz, add 0.1% of range additional error. For 50 kHz to 100 kHz, add 0.13% of range.

[5] ACV 750 range limited to 8×10^7 Volt-Hz. When the input exceeds 300 V rms, add 0.7 mV error for each additional volt.

[6] For continuous current > DC 7A or AC 7A rms, 30 seconds ON and 30 seconds OFF.

[7] When the frequency is lower than 100 Hz, the specification of slow filter is only for sine wave input.

[8] Specifications are for sinewave input >5% of range. For inputs from 1% to 5% of range, add 0.1% of range additional error. Specifications are typical values for 200 uA, 2 mA, 2 A and 10 A ranges when frequency is >1 kHz.

Measuring Characteristics

True RMS AC Voltage	
Measurement Method	AC-coupled True-RMS -- measure the ac component of input with up to 400 V DC bias on any range.
Crest Factor	≤ 5 at full range
Input Impedance	1 MΩ ± 2%, in parallel with <150 pF capacitance on any range
Input Protection	750 V rms on all ranges
AC Filter Bandwidth	Slow: 3 Hz – 300 kHz
	Medium: 20 Hz – 300 kHz
	Fast: 200 Hz – 300 kHz
CMRR (common mode rejection ratio)	70 dB, for the 1 kΩ unbalance in LO lead, <60 Hz common mode signal frequency, ±500 VDC peak maximum.
True RMS AC Current	
Measurement Method	Direct coupled to the fuse and shunt; AC-coupled True RMS measurement (measure the AC component).
Crest Factor	≤ 3 at full range
Max. Input	DC + AC current peak value <300% of range. Current with DC current component <10 A rms.
Shunt Resistor	100 Ω for 200 uA, 2 mA
	1 Ω for 20 mA, 200 mA
	0.01 Ω for 2 A, 10 A
Input Protection	Externally accessible 500 mA, 250 V high speed fuse at the rear panel for 200 uA, 2 mA, 20 mA and 200 mA ranges. Internal 10 A, 250 V high speed fuse for 2 A and 10 A ranges.
Settling Time Considerations	
The default measurement delay of the multimeter can ensure the correctness of the first readings of most of the measurements. Make sure the RC circuit of input terminal has been fully settled (about 1 s) before accurate measurement.	

Applying >300 Vrms (or >5 Arms) will cause self-heating in signal-conditioning components and the errors are included in the instrument specifications. Internal temperature changes due to self-heating may cause additional error on lower ac voltage ranges. The additional error will be less than 0.02% of reading and will generally dissipate within a few minutes.

Frequency and Period Characteristics

Accuracy Specifications: \pm (% of reading)^{[1][2]}

Function	Range	Frequency Range	24 Hour ^[3] $T_{CAL} \text{ } ^\circ\text{C} \pm 1^\circ\text{C}$	90 Day $T_{CAL} \text{ } ^\circ\text{C} \pm 5^\circ\text{C}$	1 Year $T_{CAL} \text{ } ^\circ\text{C} \pm 5^\circ\text{C}$	Temperature Coefficient 0°C to ($T_{CAL} \text{ } ^\circ\text{C} - 5^\circ\text{C}$) ($T_{CAL} \text{ } ^\circ\text{C} + 5^\circ\text{C}$) to 50°C
Frequency, Period	200 mV to 750 V	3 Hz-5 Hz	0.07	0.07	0.07	0.005
		5 Hz-10 Hz	0.04	0.04	0.04	0.005
		10 Hz-40 Hz	0.02	0.02	0.02	0.001
		40 Hz-300 kHz	0.005	0.006	0.007	0.001
		300 kHz-1 MHz	0.005	0.006	0.007	0.001

Additional Low Frequency Errors: (% of reading)

Frequency	Gate Time (Resolution)			
	1 s (0.1 ppm)	0.1 s (1 ppm)	0.01 s (10 ppm)	0.001 s (100 ppm)
3 Hz-5 Hz	0	0.12	0.12	0.12
5 Hz-10 Hz	0	0.17	0.17	0.17
10 Hz-40 Hz	0	0.20	0.20	0.20
40 Hz-100 Hz	0	0.06	0.21	0.21
100 Hz-300 Hz	0	0.03	0.21	0.21
300 Hz-1 kHz	0	0.01	0.07	0.07
>1 kHz	0	0	0.02	0.02

[1] Specifications are for 90 minutes warm-up and 1 s gate time.

[2] For frequency ≤ 300 kHz, the specification is for AC input voltage of 10% to 110% of range. For frequency > 300 kHz, the specification is for AC input voltage of 20% to 110% of range. The maximum input is limited to 750 V rms or 8×10^7 Volts-Hz (whichever is less). 200 mV range is full range input or input that is larger than the full range. For 20 mV to 200 mV inputs, multiply % of reading error by 10.

[3] Relative to calibration standards.

Measuring Characteristics

Frequency and Period	
Measurement Method	Reciprocal-counting technique, AC-coupled input using the AC voltage function.
Input Impedance	1 M Ω \pm 2%, in parallel with < 150 pF capacitance on any range
Input Protection	750 V rms on all ranges
Measurement Considerations	
All frequency counters are susceptible to error when measuring low-voltage, low-frequency signals. Shielding inputs from external noise pickup is critical for minimizing measurement errors.	
Settling Considerations	
Errors will occur when attempting to measure the frequency or period of an input following a dc offset voltage change. The input blocking RC time constant must be allowed to fully settle (about 1 s) before the most accurate measurements are possible.	

Capacitance Characteristics

Accuracy Specifications: \pm (% of reading + % of range)^{[1][2]}

Function	Range ^[2]	Test Current	1Year $T_{CAL} \text{ } ^\circ\text{C} \pm 5^\circ\text{C}$	Temperature Coefficient $0^\circ\text{C to } (T_{CAL} \text{ } ^\circ\text{C} - 5^\circ\text{C})$ $(T_{CAL} \text{ } ^\circ\text{C} + 5^\circ\text{C}) \text{ to } 50^\circ\text{C}$
Capacitance	2.000 nF	200 nA	2 + 2.5	0.05+0.05
	20.00 nF	2 μ A	1 + 0.3	0.05+0.01
	200.0 nF	10 μ A	1 + 0.3	0.01+0.01
	2.000 μ F	100 μ A	1 + 0.3	0.01+0.01
	20.00 μ F	1 mA	1 + 0.3	0.01+0.01
	200.0 μ F	1 mA	1 + 0.3	0.01+0.01
	2.000 mF	1 mA	1 + 0.3	0.01+0.01
	20.00 mF	1 mA	1 + 0.3	0.01+0.01
	100.0 mF	1 mA	3 + 0.2	0.05+0.02

[1] Specifications are for 90 minutes warm-up and REL operation. Additional errors may be caused by non-film capacitors.

[2] Specifications are for 1% to 110% of range on 2 nF range and 10% to 110% of range on all other ranges.

Measuring Characteristics

Capacitance Measurement	
Measurement Method	Apply constant current into the capacitance, and measure the voltage changing rate.
Connection Type	2-wire
Measurement Considerations	
Since small capacitance measurements are susceptible to error caused by external noise, shielding inputs from external noise pickup is critical for minimizing measurement errors.	

Temperature Characteristics

Accuracy Specifications ^[1]

Function	Probe Type	Type	Optimum Range	1 Year $T_{CAL} \text{ } ^\circ\text{C} \pm 5^\circ\text{C}$	Temperature Coefficient $0^\circ\text{C to } (T_{CAL} \text{ } ^\circ\text{C} - 5^\circ\text{C})$ $(T_{CAL} \text{ } ^\circ\text{C} + 5^\circ\text{C}) \text{ to } 50^\circ\text{C}$
Temperature	RTD ^[2] (R_0 is within 49Ω and $2.1 \text{ k}\Omega$)	$\alpha=0.00385$	$-200^\circ\text{C to } 660^\circ\text{C}$	0.16°C	0.01°C
		$\alpha=0.00389$	$-200^\circ\text{C to } 660^\circ\text{C}$	0.17°C	0.01°C
		$\alpha=0.00391$	$-200^\circ\text{C to } 660^\circ\text{C}$	0.14°C	0.01°C
		$\alpha=0.00392$	$-200^\circ\text{C to } 660^\circ\text{C}$	0.15°C	0.01°C
	Thermal Resistance	$2.2 \text{ k}\Omega$	$-40^\circ\text{C to } 150^\circ\text{C}$	0.08°C	0.002°C
		$3 \text{ k}\Omega$	$-40^\circ\text{C to } 150^\circ\text{C}$	0.08°C	0.002°C
		$5 \text{ k}\Omega$	$-40^\circ\text{C to } 150^\circ\text{C}$	0.08°C	0.002°C
		$10 \text{ k}\Omega$	$-40^\circ\text{C to } 150^\circ\text{C}$	0.08°C	0.002°C
		$30 \text{ k}\Omega$	$-40^\circ\text{C to } 150^\circ\text{C}$	0.08°C	0.002°C
	Thermocouple ^[3]	B	$0^\circ\text{C to } 1820^\circ\text{C}$	0.76°C	0.14°C
		E	$-270^\circ\text{C to } 1000^\circ\text{C}$	0.5°C	0.02°C
		J	$-210^\circ\text{C to } 1200^\circ\text{C}$	0.5°C	0.02°C
		K	$-270^\circ\text{C to } 1372^\circ\text{C}$	0.5°C	0.03°C
		N	$-270^\circ\text{C to } 1300^\circ\text{C}$	0.5°C	0.04°C
R		$-270^\circ\text{C to } 1768.1^\circ\text{C}$	0.5°C	0.09°C	
S		$-270^\circ\text{C to } 1768.1^\circ\text{C}$	0.6°C	0.11°C	
T		$-270^\circ\text{C to } 400^\circ\text{C}$	0.5°C	0.03°C	

[1] Specifications are for 90 minutes warm-up. Probe error excluded.

[2] Specification is for 4WR resistance measurement or 2WR resistance measurement using REL operation for sensor.

[3] Relative to cold junction temperature, accuracy is based on ITS-90. Built-in cold junction temperature refers to the temperature inside the banana jack and its accuracy is $\pm 2.5^\circ\text{C}$.

Measuring Characteristics**Measurement Considerations**

The built-in cold junction temperature tracks the temperature inside the banana jack. The change of temperature in banana jack might cause additional error. When using the built-in cold junction compensation, connect the sensor terminal of the thermocouple to the banana jack and warm it up for more than 3 minutes to minimize the error.

Measurement Rate

Measurement Rate ^[1]

Function	Setting	Integration Time	Readings/s 50Hz (60Hz)
DC Voltage	0.006 PLC Integration Time	100 (100) us	10000 (10000)
DC Current	0.02 PLC	400 (333) us	2500 (3000)
2-wire Resistance	0.06 PLC	1.2 (1) ms	833 (1000)
4-wire Resistance	0.2 PLC	4 (3.33) ms	250 (300)
	1 PLC	20 (16.7) ms	50 (60)
	2 PLC	40 (33.3) ms	25 (30)
	10 PLC	200 (167) ms	5 (6)
	100 PLC	2 (1.67) s	0.5 (0.6)
AC Voltage	3Hz AC Filter		0.2
AC Current ^[2]	20 Hz		1.5
	200 Hz		10
	200 Hz		50 ^[3]
Frequency and Period ^[4]	1s Gate Time		1
	0.1 s		10
	0.01 s		80
	0.001 s		500
Capacitance ^[5]			25

[1] Auto trigger, zero trigger delay, auto zero off, auto range off, math function off and external interface off.

- [2] Use the default delay setup rate (the default trigger delay).
- [3] The maximum rate available when trigger delay is set to 0.
- [4] 20V range, fast filter, 1kHz input.
- [5] Measure 20nF capacitance on 200nF range. The measurement period changes with the capacitance under test. The maximum measurement period on 100mF is 4s (typical value).

Other Measuring Characteristics

Trigger and Storage	
Trigger	Pre-trigger or Delayed-trigger, Internal Trigger or External Trigger, Rising Edge Trigger or Falling Edge Trigger
Time Base Resolution	33.333 us, 0.01% Accuracy
Trigger Delay	0 to 3600 s available (about 33 μ s step)
Sample Timer	0 to 3600 s available (about 33 μ s step)
Internal Trigger Accuracy	\pm 1% of range
Reading Hold Sensitivity	0.01%, 0.1%, 1% or 10% of reading
Single Trigger Samples	1 to 50000
External Trigger Input	Level: 5 V TTL compatible
	Impedance: >30 k Ω in parallel with 500 pF
	Delay: < 50 μ s
	Jitter: < 50 μ s (ACV, ACI, FREQ and PREIOD <2 ms)
	Polarity: rising edge, falling edge available
	Maximum Rate: 300/s
	Minimum Pulse Width: 2 μ s
VMC Output	Level: 5 V TTL compatible
	Output Impedance: 100 Ω , typical
	Output Polarity: Negative
	Pulse Width: about 2 μ s
History Record and Storage	

Volatile Memory	512k reading history data record
Non-volatile Memory	10 sets history data storage (5000 readings/group) 5 sets sensor data storage (5000 readings/group) 10 sets instrument setup storage 5 sets any sensor setup storage Support USB storage device backup of data in internal memory.

General Specifications

Display	256×64 LCD, dual display, Chinese/English menu and online help.
Power Supply	AC 100 V – 120 V, 45 Hz – 440 Hz AC 200 V – 240 V, 45 Hz – 66 Hz Detect the power frequency automatically at power-on, 400 Hz defaults to 50 Hz
Power Consumption	25 VA Max
Working Environment	Full accuracy for 0°C to 50°C Full accuracy to 80% R.H. at 40°C Non-coagulation
Storage Temperature	-40°C to 70°C
Operation Altitude	Up to 2000m
Safety	IEC 61010-1; EN 61010-1; UL 61010-1; CAN/CSA-C22.2 No. 61010-1 Measurement CAT I 1000V/CAT II 300V Pollution Degree 2
EMC	EN 61326-1
Weight	About 3.2 kg (without package)
Dimension	(height×width×length): 107.0 mm×231.6 mm×290.5 mm
Remote Interface	GPIB, 10/100Mbit LAN, USB 2.0 Full Speed Device & Host (support USB storage device), RS-232C
Programming Language	SCPI
LXI Compatibility	LXI Class C, Version 1.2
Warm-up Time	90 minutes

Chapter 7 Appendix

Appendix A: DM3068 Accessories

	Description	Order Number
Model	DM3068 (6 ½, dual-display)	DM3068
Standard Accessories	Power Cord conforming to the standard of the country	-
	Two Test Leads (black and red)	-
	Two Alligator Clips (black and red)	-
	USB Cable	CB-USB-150
	Four Spare Fuses: 2 AC, 250 V, T250 mA fuses 2 AC, 250 V, T125 mA fuses	-
	Quick Guide	-
	Resource CD (User's Guide and Application Software)	-
Optional Accessories	Kelvin Test Clip	-
	RS232 Cable	-
	Rack Mount Kit	RM-DM-3

Note: All the standard or optional accessories can be ordered from you local **RIGOL** Office.

Appendix B: Warranty

RIGOL warrants that its products mainframe and accessories will be free from defects in materials and workmanship within the warranty period.

If a product is proven to be defective within the respective period, **RIGOL** guarantees the free replacement or repair of products which are approved defective. To get repair service, please contact with your nearest **RIGOL** sales and service office.

RIGOL does not provide any other warranty items except the one being provided by this summary and the warranty statement. The warranty items include but not being subjected to the hint guarantee items related to tradable characteristic and any particular purpose. **RIGOL** will not take any responsibility in cases regarding to indirect, particular and ensuing damage.

Index

2WR	2-14	LAN	2-71
4WR	2-14	Level Trigger	2-61
AC Current	2-11	Line	2-31
AC Filter	2-45	local mode	2-61
AC Voltage	2-7	Manual IP	2-72
Any Sensor	2-26	Math	2-50
Aperture Time	2-48	MEAS_CSV	2-66
Auto Trigger	2-61	MeasData	2-66
Auto Zero	2-43	MIRR_CFG	2-66
AutoIP	2-72	None	2-76
Brightness	2-77	Odd	2-76
Capacitance	2-17	Offset Compensation	2-44
Continuity	2-19	Period	2-23
Contrast	2-77	Power On Setting	2-79
Current source	2-47	Preset	2-37
Curve	2-31	Print	2-76
DC Current	2-9	remote mode	2-61
DC Impedance	2-42	Resistance	2-14
DC Voltage	2-5	RTD	2-33
Default Gateway	2-73	S No.	2-63
Default Setting	2-79	Secondary Function Key	2-38
Delay	2-63	SEN_CSV	2-66
DHCP	2-72	Sensor	2-66
Diode	2-21	SensorData	2-66
DNS	2-73	Short-Circuit Resistance	2-46
Even	2-76	Single Trigger	2-61
External Trigger	2-61	Slope	2-63
Frequency	2-23	Subnet Mask	2-72
Front Switch	2-79	SysSetting	2-66
Gate time	2-48	TC	2-33
Integration time	2-41	Temperature sensor	2-33
Invert	2-77	THERM	2-33
IP Address	2-72	Trigger Output	2-64