

# **RIGOL**

## **Quick Guide**

English

中文

# **MSO8000 Series Digital Oscilloscope**

**Aug. 2019**

**RIGOL (SUZHOU) TECHNOLOGIES INC.**



---

# Guaranty and Declaration

## Copyright

© 2019 **RIGOL** (SUZHOU) TECHNOLOGIES INC. All Rights Reserved.

## Trademark Information

**RIGOL** is a registered trademark of **RIGOL** (SUZHOU) TECHNOLOGIES INC.

## Publication Number

QGA26102-1110

## Notices

- **RIGOL** products are covered by P.R.C. and foreign patents, issued and pending.
- **RIGOL** reserves the right to modify or change parts of or all the specifications and pricing policies at the company's sole decision.
- Information in this publication replaces all previously released materials.
- Information in this publication is subject to change without notice.
- **RIGOL** shall not be liable for either incidental or consequential losses in connection with the furnishing, use, or performance of this manual, as well as any information contained.
- Any part of this document is forbidden to be copied, photocopied, or rearranged without prior written approval of **RIGOL**.

## Product Certification

**RIGOL** guarantees that this product conforms to the national and industrial standards in China as well as the ISO9001:2015 standard and the ISO14001:2015 standard. Other international standard conformance certifications are in progress.

## Contact Us

If you have any problem or requirement when using our products or this manual, please contact **RIGOL**.

E-mail: [service@rigol.com](mailto:service@rigol.com)

Website: [www.rigol.com](http://www.rigol.com)

## General Safety Summary

1. Only the exclusive power cord designed for the instrument and authorized for use within the local country could be used.
2. Ensure that the instrument is safely grounded.
3. Observe all terminal ratings.
4. Use proper overvoltage protection.
5. Do not operate without covers.
6. Do not insert objects into the air outlet.
7. Use the proper fuse.
8. Avoid circuit or wire exposure.
9. Do not operate the instrument with suspected failures.
10. Provide adequate ventilation.
11. Do not operate in wet conditions.
12. Do not operate in an explosive atmosphere.
13. Keep instrument surfaces clean and dry.
14. Prevent electrostatic impact.
15. Handle with caution.

## Safety Notices and Symbols

### Safety Notices in this Manual:



#### **WARNING**

Indicates a potentially hazardous situation or practice which, if not avoided, will result in serious injury or death.



#### **CAUTION**

Indicates a potentially hazardous situation or practice which, if not avoided, could result in damage to the product or loss of important data.

### Safety Terms on the Product:

**DANGER** It calls attention to an operation, if not correctly performed, could result in injury or hazard immediately.

**WARNING** It calls attention to an operation, if not correctly performed, could result in potential injury or hazard.

**CAUTION** It calls attention to an operation, if not correctly performed, could result in damage to the product or other devices connected to the product.

**Safety Symbols on the Product:**Hazardous  
VoltageSafety  
WarningProtective Earth  
Terminal

Chassis Ground



Test Ground

## Care and Cleaning

### Care

Do not store or leave the instrument where it may be exposed to direct sunlight for long periods of time.

### Cleaning

Clean the instrument regularly according to its operating conditions.

1. Disconnect the instrument from all power sources.
2. Clean the external surfaces of the instrument with a soft cloth dampened with mild detergent or water. When cleaning the LCD, take care to avoid scarifying it.

**CAUTION**

To avoid damage to the instrument, do not expose it to caustic liquids.

**WARNING**

To avoid short-circuit resulting from moisture or personal injuries, ensure that the instrument is completely dry before connecting it to the power supply.

## Document Overview

This manual gives you a quick review about the front and rear panel of MSO8000 series, the user interface, and the basic operation method.

**Tip**

For the latest version of this manual, download it from the official website of **RIGOL** ([www.rigol.com](http://www.rigol.com)).

## Format Conventions in this Manual

### 1. Key

The key on the front panel is denoted by the format of "Key Name (Bold) + Text Box". For example, **Utility** denotes the "Utility" key.









### 2. Menu

The menu items are denoted by the format of "Menu Word (Bold) + Character Shading". For example, **System** denotes the "System" menu item under **Utility**.

### 3. Operation Procedures

→ denotes the next step of operation. For example, **Utility** → **System** denotes that first press **Utility**, and then press the **System** softkey.

### 4. Knob

Label	Knob	Label	Knob
<b>Horizontal SCALE</b> 	Horizontal Time Base Knob	<b>Vertical SCALE</b> 	Vertical Scale Knob
<b>Horizontal POSITION</b> 	Horizontal Position Knob	<b>Vertical OFFSET</b> 	Vertical Offset Knob
<b>Wave Vertical SCALE</b> 	Waveform Vertical Scale Knob	<b>Trigger LEVEL</b> 	Trigger Level Knob
<b>Wave Vertical POSITION</b> 	Waveform Vertical Position Knob		Multifunction Knob

## Content Conventions in this Manual

MSO8000 series includes the following models. Unless otherwise specified, this manual takes MSO8204 as an example to illustrate the functions and operation methods of MSO8000 series digital oscilloscope.

Model	Max. Analog Bandwidth	No. of Analog Channels	No. of Function/Arbitrary Waveform Generator Channels	No. of Digital Channels
MSO8064	600 MHz	4	2 (Opt.)	16 (Required to purchase the probe)
MSO8104	1 GHz	4	2 (Opt.)	16 (Required to purchase the probe)
MSO8204	2 GHz	4	2 (Opt.)	16 (Required to purchase the probe)

## General Inspection

### 1. Inspect the packaging

If the packaging has been damaged, do not dispose the damaged packaging or cushioning materials until the shipment has been checked for completeness and has passed both electrical and mechanical tests.

The consigner or carrier shall be liable for the damage to the instrument resulting from shipment. **RIGOL** would not be responsible for free maintenance/rework or replacement of the instrument.

### 2. Inspect the instrument

In case of any mechanical damage, missing parts, or failure in passing the electrical and mechanical tests, contact your **RIGOL** sales representative.

### 3. Check the accessories

Please check the accessories according to the packing lists. If the accessories are damaged or incomplete, please contact your **RIGOL** sales representative.

## Product Overview

MSO8000 series is a medium and high-end mixed signal digital oscilloscope designed on the basis of the ASIC chip (**RIGOL** self-owns its intellectual property right) and UltraVision II technical platform developed by **RIGOL**. Integrating 7 independent instruments into one, the MSO8000 series is equipped with the analog bandwidth of up to 2 GHz, extremely high memory depth of 500 Mpts, sound waveform display effects, excellent waveform capture rate, and powerful data analysis functions. Many of its specifications have reached the top level in the industry. Meanwhile, it supports the real-time eye diagram measurement and jitter analysis. Its cost-effective features and high performance make it prominent as the 2 GHz mixed signal digital oscilloscope.

For descriptions of the front panel, refer to Figure 1 and Table 1; for descriptions of the rear panel, refer to Figure 2 and Table 2; and for descriptions of the main interface (display screen), refer to Figure 3 and Table 3.

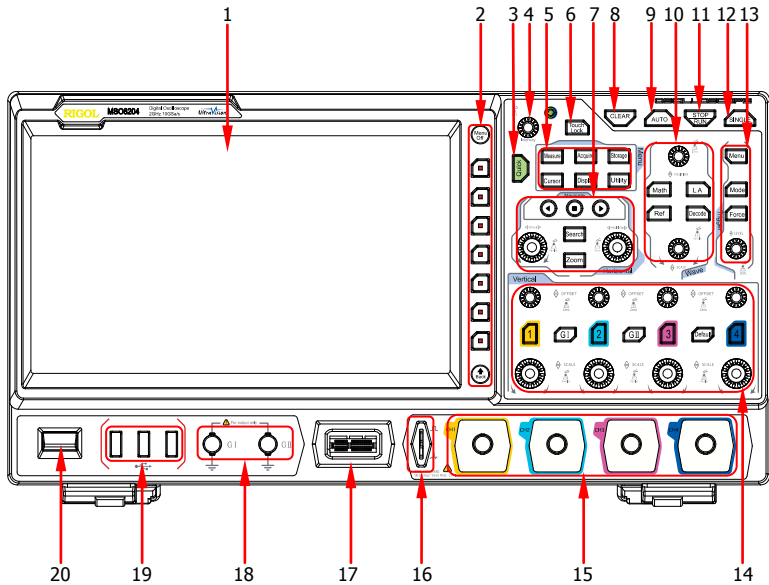

Figure 1 Front Panel

Table 1 Front Panel Description

No.	Description	No.	Description
1	Capacitive Touch Screen	11	RUN/STOP Key
2	Function Menu Operation Keys	12	Single Trigger Control Key
3	Quick Key (Shortcut Key)	13	Trigger Control System
4	Multifunction Knob	14	Vertical Control System
5	Common Operation Keys	15	Analog Channel Input Terminals
6	Touch Lock Key	16	Probe Compensation Signal Output Terminal/Ground Terminal
7	Horizontal Control System	17	Digital Channel Input Interface
8	CLEAR Key	18	Dual-channel Function/Arbitrary Waveform Generator Output Terminals <sup>[1]</sup>
9	Auto Waveform Display Key	19	USB HOST Interface
10	Waveform Control System	20	Power Key

**Note:**<sup>[1]</sup> This port function needs to be activated by purchasing the MSO8000-AWG option.



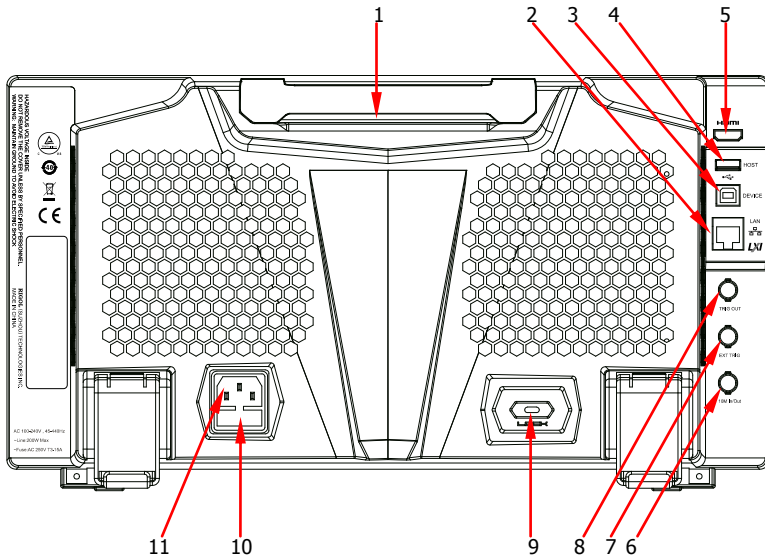

Figure 2 Rear Panel

Table 2 Rear Panel Description

No.	Description
1	Handle
2	LAN Interface
3	USB DEVICE Interface
4	USB HOST Interface
5	HDMI Video Output
6	Reference Clock Input/Output
7	EXT Trigger Input
8	Trigger Output Interface
9	Kensington Security Lock Hole
10	Fuse
11	AC Power Cord Connector

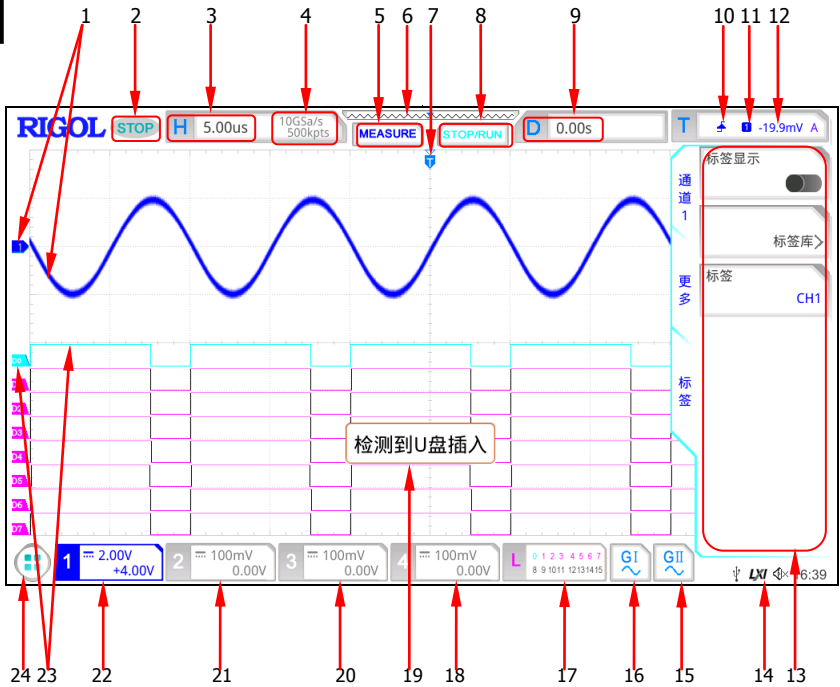

Figure 3 User Interface

Table 3 User Interface Icons

No.	Description	No.	Description
1	Analog Channel Label and Waveform	13	Operation Menu
2	Operating Status	14	Notification Area
3	Horizontal Time Base	15	Arbitrary Waveform Generator 2 Waveform Label
4	Sample Rate and Memory Depth	16	Arbitrary Waveform Generator 1 Waveform Label
5	Auto Measurement Label	17	Digital Channel Status Area
6	Waveform Memory	18	CH4 Status Label
7	Trigger Position	19	Message Box
8	RUN/STOP Label	20	CH3 Status Label
9	Horizontal Position	21	CH2 Status Label
10	Trigger Type	22	CH1 Status Label
11	Trigger Source	23	Digital Channel Label and Waveform
12	Trigger Level/Threshold Level	24	Function Navigation

## To Prepare for Use

### To Adjust the Supporting Legs

Adjust the supporting legs properly to use them as stands to tilt the oscilloscope upwards for stable placement of the oscilloscope as well as better operation and observation, as shown in Figure 4.

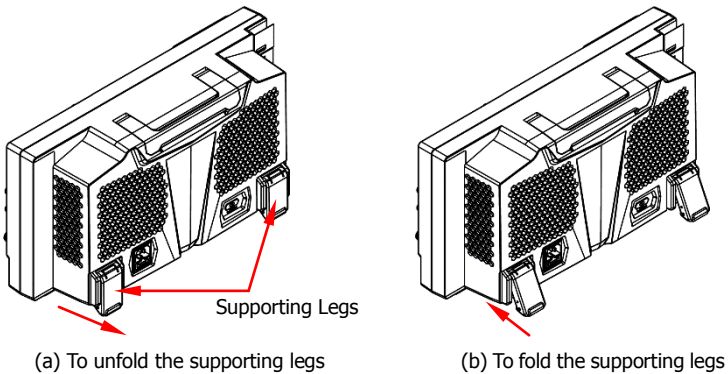

Figure 4 To Adjust the Supporting Legs

### To Connect to AC Power

The input AC power requirements of the oscilloscope are 100~240 V, 45~440 Hz. Please use the power cord provided in the accessories to connect the oscilloscope to the AC power source via the power cord connector, as shown in Figure 5.

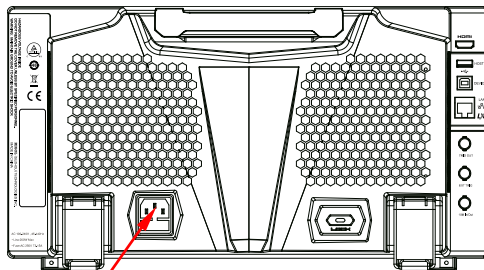



Figure 5 To Connect to AC Power

## Turn-on Checkout

When the oscilloscope is connected to power, press the Power key  at the lower-left corner of the front panel to start the oscilloscope. (You can also press **Utility** → **System** → **Power status**, and select "Switch On". After the instrument is connected to power source, it will start directly.) During the start-up process, the oscilloscope performs a series of self-tests. After the self-test, the welcome screen is displayed.

## To Set the System Language

MSO8000 series oscilloscope supports multiple system languages. You can press **Utility** → **Language** to set the system language.

## To Connect the Probe

**RIGOL** provides the passive probe, the active probe, and the logic probe for MSO8000 series. For specific probe models, please refer to *MSO8000 Series Datasheet*. For detailed technical information of the probes, please refer to the specified Probe User's Guide.

### Connect the passive probe:

1. Connect the BNC terminal of the probe to an analog channel input terminal of the oscilloscope on the front panel, as shown in Figure 6.
2. Connect the ground alligator clip or spring of the probe to the circuit ground terminal, and then connect the probe tip to the circuit point to be tested.

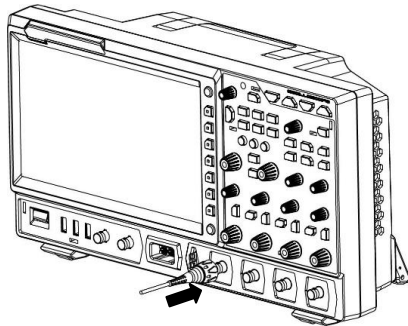

Figure 6 To Connect the Passive Probe

After you connect the passive probe, check the probe function and probe

compensation adjustment before making measurements. For detailed procedures, refer to "**Function Inspection**" and the "**Probe Compensation**" sections introduced in this manual.

### Connect the active probe:

Take RP7150 (the active differential probe) as an example.

1. Connect the probe head to the preamp of the active probe, as shown in Figure 7.

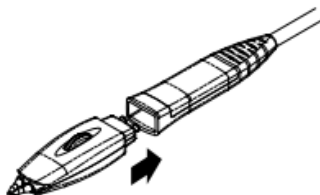

Figure 7 To Connect the Probe Head to the Preamp of the Active Probe

2. Connect the other end of the preamp to an analog channel input terminal of the oscilloscope on the front panel, as shown in Figure 8. Note that you should push the probe to the end to ensure that it is tightly connected.

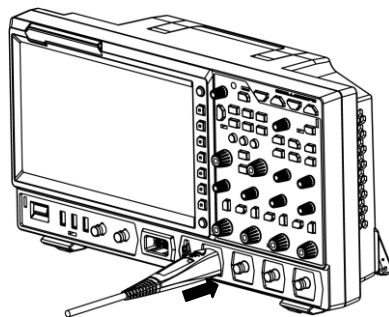

Figure 8 To Connect the Active Probe

3. Use the probe auxiliary equipment to connect the probe front to the circuit under test. For details about the probes, refer to *RP7000 Series Active Probe User's Guide*.

After connecting the active probe, you can perform probe calibration and offset voltage adjustment if necessary. For detailed procedures, refer to the descriptions of the active probe in user's guide.

### Connect the logic probe:

1. Connect the output terminal of the logic probe to the digital channel input terminal on the front panel of the oscilloscope in the correct direction, as shown in Figure 9.
2. Connect the other terminal of the logic probe to the signal terminal under test. **RIGOL's** MSO8000 series has a configuration of a logic probe RPL2316. To apply to different application scenarios, RPL2316 provides three connection methods to connect the signal under test. For details, refer to *RPL2316 Logic Probe User's Guide*.

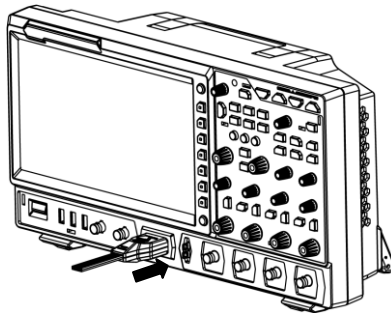

Figure 9 To Connect the Logic Probe

### Note:

- Before you connect the logic probe to the signal under test, connect logic probe's adapter provided in the accessories to its corresponding channel group.
- The digital channel input terminal does not support hot plugging. Please do not insert or pull out the logic probe when the instrument is in power-on state.

## Function Inspection

1. Press **Default** on the front panel, and then a prompt message "Restore default?" is displayed. Press or tap **OK** to restore the oscilloscope to its factory default settings.
2. Connect the ground alligator clip of the probe to the "Ground Terminal" as shown in Figure 10 below.
3. Use the probe to connect the input terminal of CH1 of the oscilloscope and the "Compensation Signal Output Terminal" of the probe, as shown in Figure 10.

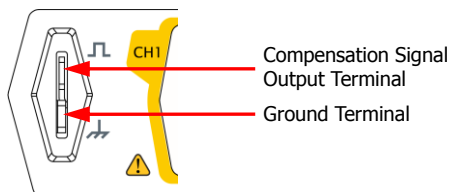

Figure 10 To Use the Compensation Signal

4. Set the probe attenuation to 10X, and then press **AUTO**.
5. Observe the waveform on the display. In normal condition, the square waveform as shown in Figure 11 should be displayed.

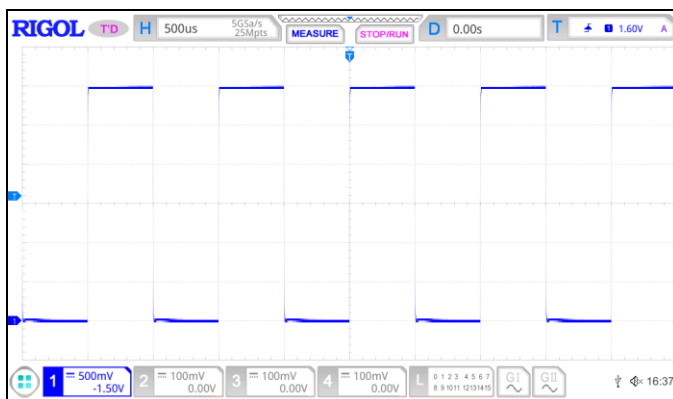

Figure 11 Square Waveform Signal

6. Use the same method to test the other channels. If the square waveforms actually shown do not match that in the figure above, please perform "**Probe Compensation**" introduced in this manual.

**WARNING**

To avoid electric shock when using the probe, please make sure that the insulated wire of the probe is in good condition. Do not touch the metallic part of the probe when the probe is connected to high voltage source.

## Probe Compensation

When the probes are used for the first time, you should compensate the probes to make them match the input channels of the oscilloscope. Non-compensated or poorly compensated probes may cause measurement inaccuracy or errors. The probe compensation procedures are as follows:

1. Perform Step 1, 2, 3 and 4 specified in "**Function Inspection**".
2. Check the displayed waveforms and compare them with Figure 12.

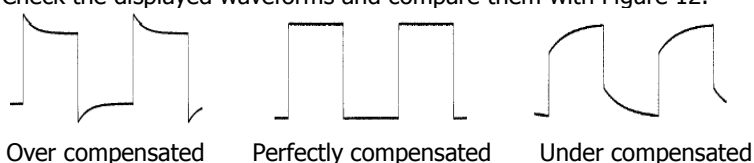

Figure 12 Probe Compensation

3. Use a nonmetallic screwdriver to adjust the low-frequency compensation adjustment hole on the probe until the waveform is displayed as "Perfectly compensated" in the figure above.

## Touch Screen Operation

MSO8000 series provides a 10.1-inch super large capacitive touch screen, which supports multi-touch and gesture operation. It has strong waveform display capability and excellent user experience. It features great convenience, high flexibility, and great sensitivity. The actions supported by the touch screen controls include tapping, pinching&stretching, dragging as well as rectangle drawing.

### Tap

Use one finger to touch the symbol or characters on the screen slightly, as shown in Figure 13. The actions supported by the tap action include:

- Tap and operate the menus on the menu.
- Tap the function navigation icon  at the lower-left corner of the touch screen to enable the function navigation.
- Tap the displayed numeric keypad to set the parameters.
- Tap the virtual keypad to set the label name and the filename.
- Tap close button at the upper-right corner of the message box to close it.
- Tap and operate the windows on the screen.





Figure 13 Tap Gesture

## Pinch&Stretch

Pinch or stretch two points on the screen with two fingers to zoom in or out the waveform. To zoom in the waveform, first pinch the two fingers and then stretch the fingers; to zoom out the waveform, first stretch the two fingers, and then pinch the fingers together, as shown in Figure 14. The actions supported by the pinch action include:

- Pinching&stretching in the horizontal direction can adjust the horizontal time base of the waveform.
- Pinching&stretching in the vertical direction can adjust the vertical scale of the waveform.

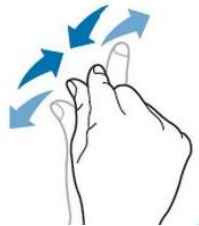

Figure 14 Pinch&amp;Stretch Gesture

## Drag

Use one finger to select the object, and then drag the object to a destination place, as shown in Figure 15. The actions supported by the drag action include:

- Drag the waveform to change its position or offset.
- Drag the window controls to change the positions of the controls (e.g. numeric keypad).
- Drag the marker to change the position of the marker.

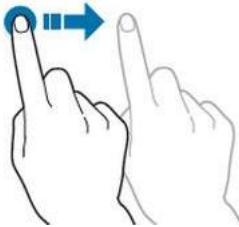

Figure 15 Drag Gesture

## Rectangle Drawing

Enable the function navigation, and then tap the "Draw rect" icon to switch to the rectangle drawing mode. Drag to draw a rectangle on the screen, as shown in Figure 16. The actions supported by the rectangle drawing include:

- Select "Trigger zone A":
  - Draw the region for Trigger zone A;
  - Open Trigger zone A;
  - Open the "Zone trig" menu.
- Select "Trigger zone B":
  - Draw the area for Trigger zone B;
  - Open Trigger zone B;
  - Open the "Zone trig" menu.
- Select "Histogram":
  - Draw the region for the histogram;
  - Open the "Histogram" menu.
- Select "Horizontal zoom": expands the waveforms in the horizontal direction.
- Select "Vertical zoom": expands the waveforms in the vertical direction.
- Select "waveform zoom": expands the waveforms both in the horizontal and vertical direction.

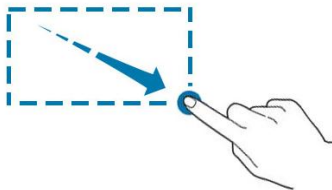



Figure 16 Rectangle Drawing Gesture

## To Use the Built-in Help System

The help system of this oscilloscope provides instructions for all the function keys on the front panel and their corresponding menu keys. The steps for opening the built-in help system are as follows:

1. Press **Utility** → **System** → **Help**, and then the "Help" menu is displayed on the screen. You can also use the touch screen function, tap the function navigation icon  at the lower-left corner of the touch screen to enable the function navigation. Tap the "Help" icon, and then the "Help" menu is displayed on the screen.
2. Press **Help**, and then the help information is displayed on the screen, as shown in Figure 17. The help interface mainly consists of two sections. The left section lists "Help Options", and the right section is the "Help Display Area".

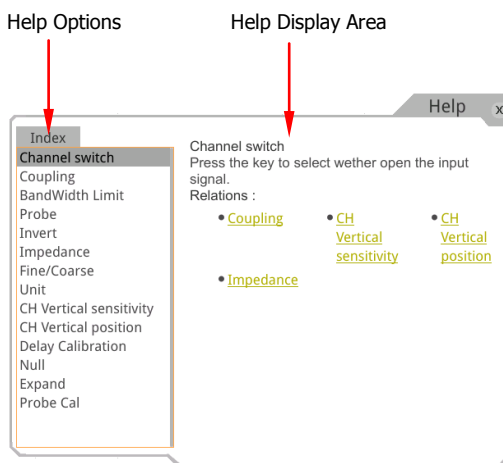



Figure 17 Help Information

After opening the help interface, you can get its help information in the "Help Display Area" through the following three methods:

### Method 1:

For the keys, you can directly press the front-panel keys (except the Power key , the **Menu Off** key and **Back** key) to obtain the help information. For the buttons, you can rotate the knob or press down the knob to get the help information (except the multifunction knob ). As the function of rotating the

knob is different from that of pressing down the knob, these two operations will give you different help information.



**Method 2:**

In the "Help Options", rotate the multifunction knob  to switch among the help options to get the corresponding help information.

**Method 3:**

Enable the touch screen and tap the desired help option to get the corresponding help information.

**Tip**

- Help information for other keys and buttons:
  - Power key : powers on/off the instrument.
  - **Menu Off** key: displays or hides menus. By default, menus are displayed. If menus are hidden, pressing this key can display the menus again.
  - **Back** key: returns to the previous menu or the last set function menu.
  - Multifunction knob : In non-menu-operation mode, rotate this knob to adjust the brightness of waveform display. When you operate on the menu, this knob is illuminated. For the menu item that has multiple parameters under it, when you press the menu softkey, rotate the knob to select the parameter item, then press down the knob to select it (sometimes, the specified parameter item can be selected by rotating the knob). It can also be used to modify parameters, input a filename, etc.
- If the menu item is grayed out, you cannot press the corresponding front-panel menu key to obtain the help information. What you can do is only to follow the above Method 2 or 3 to get the help information.



# Parameter Setting Method

For the MSO8000 series, you can use the multifunction knob or enable the touch screen to set the parameters of MSO8000 series. The common parameter setting methods are as follows:



## Method 1:

For the parameters with the sign , rotate the multifunction knob  on the front panel directly to select the parameter item or modify the parameter value.

## Method 2:

For the parameters with the sign , rotate the multifunction knob  on the front panel and press it down to select the parameter item or modify the parameter value.

## Method 3:

For the parameters with  displayed on the menu, rotate the multifunction knob  on the front panel directly to set the parameter, or press down the multifunction knob  or the specified menu softkey, and then the numeric keypad is shown in Figure 18 below.

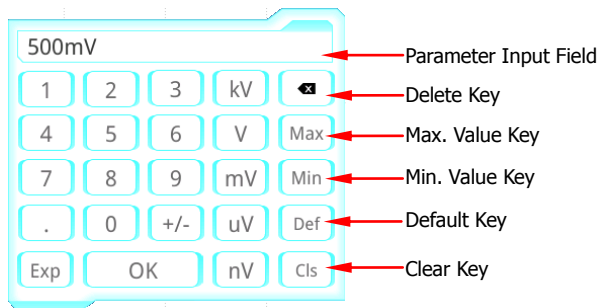



Figure 18 Numeric Keypad

In the numeric keypad, rotate the multifunction knob  to select the parameter, then press down the knob to select it. Then input the value or the unit. You can also enable the touch screen and tap the value or unit in the numeric keypad to input them. After you input all the values and select the desired units, the numeric keypad is turned off automatically. This indicates that you have completed parameter setting. Besides, after you have input the

values, you can also press **OK** directly to close the numeric keypad. At this time, the unit of the parameter is the default unit. In the numeric keypad, you can also perform the following operations:

- Delete the parameter value that has been input.
- Set the parameter to a maximum or minimum value (sometimes, the maximum or minimum value are the specified one for the current state).
- Set the parameter to a default value.
- Clear the parameter input field.

**Method 4:**

For the parameters without the above signs, press the desired menu softkey to switch between the parameter items. This method is applicable to the parameters with only two available options.

**Tip**

The above method is commonly used for the parameter settings of the oscilloscope. For other methods of parameter settings, refer to details in relevant chapters of *MSO8000 User's Guide*.

## Fuse Replacement

If you need to replace the fuse, use only the specified fuse (AC 250 V, T3.15 A; 5.2 mm×20 mm) and perform the following operations, as shown in Figure 19:

1. Turn off the instrument, cut off the power, and remove the power cord.
2. Use a small straight slotted screwdriver to pry out the fuse holder.
3. Take out the fuse.
4. Replace the old fuse with a specified fuse.
5. Install the fuse holder.

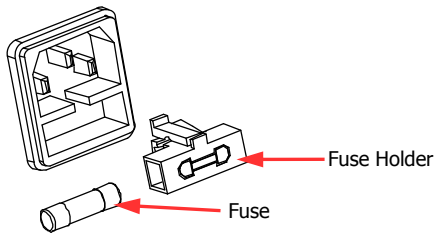

Figure 19 Fuse Replacement



### **WARNING**

To avoid electric shock, please ensure that the instrument has been turned off, the power source has been cut off, and the fuse to be used conforms to the fuse rating.

# Remote Control

MSO8000 series digital oscilloscope can be connected to the PC via the USB, LAN, or GPIB interface to set up communication and realize remote control through the PC. The remote control can be realized by using SCPI (Standard Commands for Programmable Instruments) commands. MSO8000 series digital oscilloscope supports three ways of remote control: user-defined programming, PC software (e.g. **RIGOL** Ultra Sigma), and Web Control.

## More Product Information

### 1. Obtain the device information

Press **Utility** → **System** → **About** to obtain the information of the instrument, such as the manufacturer, model, serial number, hardware version number, etc. You can also open the "Help" menu, and then press **About** to obtain the device information.

### 2. View the option information and the option installation

The instrument is installed with the trial versions of the options before leaving factory. When you power on the instrument for the first time after leaving factory, the trial time is about 2,160 minutes. Open the "Help" menu, and then press **Option list** to view the options currently installed on the oscilloscope and their information. Press **Option setup** to install the option. For detailed setting methods, refer to descriptions in *MSO8000 User's Guide*.

For more information about this instrument, refer to the relevant manuals by logging in to the official website of **RIGOL** ([www.rigol.com](http://www.rigol.com)) to download them.

*MSO8000 User's Guide*: introduces the functions of the instrument and the operation methods, remote control methods, possible failures and solutions in using the instrument, the technical specifications, and order information.

*MSO8000 Programming Guide*: provides detailed descriptions of SCPI commands and programming examples of the instrument.

*MSO8000 Datasheet*: provides the main features and technical specifications of the instrument.