

# **RIGOL**

## **Programming Guide**

### **MSO8000 Series Digital Oscilloscope**

**Jul. 2019**

**RIGOL (SUZHOU) TECHNOLOGIES INC.**



# Guaranty and Declaration

## Copyright

© 2019 **RIGOL** (SUZHOU) TECHNOLOGIES INC. All Rights Reserved.

## Trademark Information

**RIGOL** is a registered trademark of **RIGOL** (SUZHOU) TECHNOLOGIES INC.

## Publication Number

PGA26103-1110

## Software Version

00.00.00.04.00

Software upgrade might change or add product features. Please acquire the latest version of the manual from **RIGOL** website or contact **RIGOL** to upgrade the software.

## Notices

- **RIGOL** products are covered by P.R.C. and foreign patents, issued and pending.
- **RIGOL** reserves the right to modify or change parts of or all the specifications and pricing policies at the company's sole decision.
- Information in this publication replaces all previously released materials.
- Information in this publication is subject to change without notice.
- **RIGOL** shall not be liable for either incidental or consequential losses in connection with the furnishing, use, or performance of this manual, as well as any information contained.
- Any part of this document is forbidden to be copied, photocopied, or rearranged without prior written approval of **RIGOL**.

## Product Certification

**RIGOL** guarantees that this product conforms to the national and industrial standards in China as well as the ISO9001:2015 standard and the ISO14001:2015 standard. Other international standard conformance certifications are in progress.

## Contact Us

If you have any problem or requirement when using our products or this manual, please contact **RIGOL**.

E-mail: [service@rigol.com](mailto:service@rigol.com)

Website: [www.rigol.com](http://www.rigol.com)

# Document Overview

This manual is your guide to programming **RIGOL** MSO8000 series digital oscilloscope. MSO8000 series can communicate with the PC via the USB, LAN, or GPIB (requiring to work with **RIGOL**'s USB-GPIB interface converter) interface.

## Main Topics in this Manual:

### Chapter 1 SCPI Command Overview

This chapter introduces the syntax, symbols, parameters, and abbreviation rules of the SCPI commands.

### Chapter 2 Command System

This chapter introduces the syntax, function, parameters, and descriptions of each command.

### Chapter 3 Programming Examples

This chapter illustrates how to control the MSO8000 series digital oscilloscope by programming in Excel, LabVIEW, Visual Basic, and Visual C++.

#### Tip

For the latest version of this manual, download it from the official website of **RIGOL** ([www.rigol.com](http://www.rigol.com)).

## Format Conventions in this Manual:

### 1. Key

The key on the front panel is denoted by the format of "Key Name (Bold) + Text Box" in the manual. For example, **Utility** denotes the "Utility" key.

### 2. Menu

The menu items are denoted by the format of "Menu Word (Bold) + Character Shading". For example, **System** denotes the "System" menu item under **Utility**.

### 3. Operation Procedures:

"→" denotes the next step of operation. For example, **Utility** → **System** denotes that first press **Utility**, and then press the **System** softkey.

## Content Conventions in this Manual:

MSO8000 series includes the following models. Unless otherwise specified, this manual takes MSO8104 as an example to illustrate the functions and operation methods of MSO8000 series.

Model	Max. Analog Bandwidth	No. of Analog Channels	No. of Function/Arbitrary Waveform Generator Channels	No. of Digital Channels
MSO8064	600 MHz	4	2 (Opt.)	16 (Required to purchase the probe)
MSO8104	1 GHz	4	2 (Opt.)	16 (Required to purchase the probe)
MSO8204	2 GHz	4	2 (Opt.)	16 (Required to purchase the probe)

# Contents

<b>Guaranty and Declaration .....</b>	<b>I</b>
<b>Document Overview .....</b>	<b>II</b>
<b>Chapter 1 SCPI Command Overview .....</b>	<b>1-1</b>
Syntax .....	1-1
Symbol Description .....	1-1
Parameter Type .....	1-2
Command Abbreviation .....	1-2
<b>Chapter 2 Command System.....</b>	<b>2-1</b>
:AUTOscale .....	2-2
:CLEar.....	2-2
:RUN.....	2-2
:STOP .....	2-2
:SINGle.....	2-3
:TFORce.....	2-3
:ACQuire Commands.....	2-4
:ACQuire:AVERages.....	2-4
:ACQuire:MDEPth.....	2-4
:ACQuire:TYPE .....	2-5
:ACQuire:SRATe?.....	2-6
:ACQuire:LA:SRATe? .....	2-6
:ACQuire:LA:MDEPth? .....	2-6
:ACQuire:AALias.....	2-6
:BUS<n> Commands.....	2-7
:BUS<n>:MODE .....	2-7
:BUS<n>:DISPlay .....	2-8
:BUS<n>:FORMat .....	2-8
:BUS<n>:EVENT .....	2-8
:BUS<n>:EVENT:FORMat.....	2-9
:BUS<n>:EVENT:VIEW .....	2-9
:BUS<n>:LABel .....	2-9
:BUS<n>:DATA? .....	2-10
:BUS<n>:EEXPort .....	2-10
:BUS<n>:POSition .....	2-11
:BUS<n>:THReshold.....	2-11
:BUS<n>:PARAllel.....	2-12
:BUS<n>:RS232 (Option) .....	2-16
:BUS<n>:IIC (Option).....	2-21
:BUS<n>:SPI (Option) .....	2-23
:BUS<n>:CAN (Option) .....	2-29
:BUS<n>:FLEXray (Option) .....	2-31
:BUS<n>:LIN (Option) .....	2-33
:BUS<n>:IIS (Option).....	2-35
:BUS<n>:M1553 (Option) .....	2-38
:CHANnel<n> Commands .....	2-39
:CHANnel<n>:BWLimit.....	2-39
:CHANnel<n>:COUPLing .....	2-40
:CHANnel<n>:DISPlay .....	2-40
:CHANnel<n>:INVert .....	2-40
:CHANnel<n>:OFFSet .....	2-41
:CHANnel<n>:TCALibrate.....	2-41
:CHANnel<n>:SCALe .....	2-42
:CHANnel<n>:IMPedance.....	2-42
:CHANnel<n>:CStArt .....	2-43
:CHANnel<n>:PROBe.....	2-43

:CHANnel<n>:PROBe:DELAy .....	2-43
:CHANnel<n>:PROBe:BIAS .....	2-44
:CHANnel<n>:UNITs .....	2-44
:CHANnel<n>:VERNier .....	2-44
:CLOCK Commands .....	2-46
:CLOCK:METhod .....	2-46
:CLOCK:TYPE .....	2-46
:CLOCK:RATE .....	2-47
:CLOCK:PLL:ORDer .....	2-47
:CLOCK:PLL:BW .....	2-47
:CLOCK:EXTChan .....	2-48
:COUNter Commands .....	2-49
:COUNter:CURRent? .....	2-49
:COUNter:CURRent? .....	2-49
:COUNter:ENABle .....	2-49
:COUNter:SOURce .....	2-49
:COUNter:MODE .....	2-50
:COUNter:NDIGits .....	2-50
:COUNter:TOTAlize:ENABle .....	2-50
:COUNter:TOTAlize:CLear .....	2-51
:CURSor Commands .....	2-52
:CURSor:MODE .....	2-53
:CURSor:MANual .....	2-54
:CURSor:TRACk .....	2-60
:CURSor:XY .....	2-65
:DISPlay Commands .....	2-68
:DISPlay:CLear .....	2-68
:DISPlay:TYPE .....	2-68
:DISPlay:GRADing:TIME .....	2-69
:DISPlay:WBRightness .....	2-69
:DISPlay:GRID .....	2-69
:DISPlay:GBRightness .....	2-70
:DISPlay:DATA? .....	2-70
:DISPlay:RULers .....	2-70
:DISPlay:COLor .....	2-71
:DVM Commands .....	2-72
:DVM:CURRent? .....	2-72
:DVM:ENABle .....	2-72
:DVM:SOURce .....	2-72
:DVM:MODE .....	2-73
:EYE Commands .....	2-74
:EYE:ENABle .....	2-74
:EYE:SOURce .....	2-74
:EYE:MEASure:ENABle .....	2-75
:EYE:MEASure:ITEM .....	2-75
:HISTogram Commands .....	2-76
:HISTogram:DISPlay .....	2-76
:HISTogram:TYPE .....	2-76
:HISTogram:SOURce .....	2-77
:HISTogram:SIZE .....	2-77
:HISTogram:STATic .....	2-77
:HISTogram:RESet .....	2-78
:HISTogram:BLIMit .....	2-78
:HISTogram:LLIMit .....	2-78
:HISTogram:RLIMit .....	2-78
:HISTogram:TLIMit .....	2-79
IEEE488.2 Common Commands .....	2-80
*CLS .....	2-80

*ESE .....	2-80
*ESR? .....	2-80
*IDN? .....	2-81
*OPC.....	2-81
*SAV .....	2-81
*RCL .....	2-81
*RST .....	2-81
*SRE .....	2-82
*STB? .....	2-82
*TST? .....	2-82
*WAI.....	2-82
:JITter Commands.....	2-83
:JITter:ENABle.....	2-83
:JITter:SOURce .....	2-83
:JITter:HISTogram:APPLY .....	2-84
:JITter:TREND:APPLY .....	2-84
:JITter:MEASure:TYPE .....	2-84
:JITter:MEASure:ITEM .....	2-85
:JITter:MEASure:STATistic:ITEM .....	2-85
:JITter:MEASure:ENABle .....	2-85
:JITter:SLOPe .....	2-86
:LA Commands .....	2-87
:LA:STATe .....	2-87
:LA:ACTive.....	2-88
:LA:AUTOsort.....	2-88
:LA:DELeTe .....	2-88
:LA:DIgital:DISPlay .....	2-89
:LA:DIgital:POSition .....	2-89
:LA:DIgital:LABel .....	2-90
:LA:POD<n>:DISPlay .....	2-90
:LA:DISPlay .....	2-90
:LA:POD<n>:THReshold.....	2-91
:LA:SIZE .....	2-91
:LA:TCALibrate.....	2-92
:LA:GROUp:APPend .....	2-92
:LAN Commands .....	2-93
:LAN:DHCP .....	2-93
:LAN:AUTOip .....	2-94
:LAN:GATeway .....	2-94
:LAN:DNS .....	2-94
:LAN:MAC? .....	2-95
:LAN:DSErver? .....	2-95
:LAN:MANual .....	2-95
:LAN:IPADdress .....	2-96
:LAN:SMASk .....	2-96
:LAN:STATus? .....	2-96
:LAN:VISA?.....	2-97
:LAN:MDNS .....	2-97
:LAN:HOST:NAME .....	2-97
:LAN:DESCRiption .....	2-97
:LAN:APPLY.....	2-98
:MASK Commands .....	2-99
:MASK:ENABle .....	2-99
:MASK:SOURce .....	2-99
:MASK:OPERate .....	2-100
:MASK:MDISplay.....	2-100
:MASK:X.....	2-101
:MASK:Y.....	2-101

:MASK:CREate.....	2-101
:MASK:RESet.....	2-101
:MATH<n> Commands.....	2-102
:MATH<n>:DISPlay.....	2-103
:MATH<n>:OPERator.....	2-103
:MATH<n>:SOURce1.....	2-104
:MATH<n>:SOURce2.....	2-104
:MATH<n>:LSOURce1.....	2-104
:MATH<n>:LSOURce2.....	2-105
:MATH<n>:SCALe.....	2-105
:MATH<n>:OFFSet.....	2-106
:MATH<n>:INVert.....	2-106
:MATH<n>:RESet.....	2-106
:MATH<n>:FFT:SOURce.....	2-107
:MATH<n>:FFT:WINDow.....	2-107
:MATH<n>:FFT:UNIT.....	2-107
:MATH<n>:FFT:SCALe.....	2-108
:MATH<n>:FFT:OFFSet.....	2-108
:MATH<n>:FFT:HSCale.....	2-108
:MATH<n>:FFT:HCENter.....	2-109
:MATH<n>:FFT:FREQuency:START.....	2-109
:MATH<n>:FFT:FREQuency:END.....	2-109
:MATH<n>:FFT:SEARch:ENABLE.....	2-110
:MATH<n>:FFT:SEARch:NUM.....	2-110
:MATH<n>:FFT:SEARch:THReshold.....	2-110
:MATH<n>:FFT:SEARch:EXCurSION.....	2-111
:MATH<n>:FFT:SEARch:ORDer.....	2-111
:MATH<n>:FILTer:TYPE.....	2-111
:MATH<n>:FILTer:W1.....	2-112
:MATH<n>:FILTer:W2.....	2-113
:MATH<n>:SENSitivity.....	2-113
:MATH<n>:DISTance.....	2-113
:MATH<n>:THReshold1.....	2-114
:MATH<n>:THReshold2.....	2-114
:MATH<n>:THReshold3.....	2-115
:MATH<n>:THReshold4.....	2-115
:MEASure Commands.....	2-116
:MEASure:SOURce.....	2-116
:MEASure:COUNter:ENABLE.....	2-117
:MEASure:COUNter:SOURce.....	2-117
:MEASure:COUNter:VALue?.....	2-118
:MEASure:CLEar.....	2-118
:MEASure:THReshold:SOURce.....	2-118
:MEASure:THReshold:DEFault.....	2-118
:MEASure:MODE.....	2-118
:MEASure:AMSource.....	2-119
:MEASure:SETup:MAX.....	2-119
:MEASure:SETup:MID.....	2-120
:MEASure:SETup:MIN.....	2-120
:MEASure:SETup:PSA.....	2-120
:MEASure:SETup:PSB.....	2-121
:MEASure:SETup:DSA.....	2-121
:MEASure:SETup:DSB.....	2-122
:MEASure:STATistic:DISPlay.....	2-122
:MEASure:STATistic:RESet.....	2-122
:MEASure:STATistic:ITEM.....	2-122
:MEASure:ITEM.....	2-123
:MEASure:AREA.....	2-124



:MEASure:CREGion:CAX .....	2-124
:MEASure:CREGion:CBX .....	2-125
:MEASure:CATegory .....	2-125
:POWer Commands.....	2-126
:POWer:TYPE.....	2-126
:POWer:CURRentsource.....	2-126
:POWer:VOLTagesource .....	2-127
:POWer:QUALity:FREQREFerence .....	2-127
:POWer:REFLevel:METHod .....	2-127
:POWer:REFLevel:PERCent:HIGH .....	2-128
:POWer:REFLevel:PERCent:LOW .....	2-128
:POWer:REFLevel:PERCent:MID .....	2-128
:Quick Command .....	2-129
:Quick:OPERation.....	2-129
:RECORD Commands .....	2-130
:RECORD:ENABle .....	2-130
:RECORD:START.....	2-130
:RECORD:PLAY .....	2-131
:RECORD:CURRent .....	2-131
:RECORD:FRAMES.....	2-131
:REFerence Commands .....	2-132
:REFerence:DISPlay .....	2-132
:REFerence:SOURce .....	2-132
:REFerence:VSCale.....	2-133
:REFerence:VOFFset.....	2-133
:REFerence:RESet .....	2-134
:REFerence:CURRent .....	2-134
:REFerence:SAVE .....	2-134
:REFerence:COLor .....	2-134
:REFerence:LABel:ENABle .....	2-135
:REFerence:LABel:CONTent.....	2-135
:SAVE and :Load Commands .....	2-136
:SAVE:CSV .....	2-136
:SAVE:CSV:LENGth.....	2-136
:SAVE:FORMat .....	2-137
:SAVE:IMAGe .....	2-137
:SAVE:IMAGe:TYPE .....	2-137
:SAVE:IMAGe:INVert .....	2-138
:SAVE:IMAGe:COLor.....	2-138
:SAVE:SETup.....	2-138
:SAVE:WAVEform .....	2-139
:SAVE:STATus?.....	2-139
:LOAD:SETup.....	2-139
:SEARch Commands .....	2-140
:SEARch:STATe .....	2-140
:SEARch:MODE .....	2-141
:SEARch:EVENT .....	2-141
:SEARch:EDGE:SLOPe .....	2-141
:SEARch:EDGE:SOURce .....	2-142
:SEARch:PULSe:POLarity .....	2-142
:SEARch:PULSe:QUALifier.....	2-142
:SEARch:PULSe:SOURce.....	2-143
:SEARch:RUNT:POLarity .....	2-143
:SEARch:RUNT:QUALifier .....	2-143
:SEARch:RUNT:SOURce .....	2-144
:SEARch:SLOPe:POLarity .....	2-144
:SEARch:SLOPe:QUALifier.....	2-145
:SEARch:SLOPe:SOURce.....	2-145

[:SOURce[<n>]] Commands .....	2-146
[:SOURce[<n>]]:FREQuency[:FIXed] .....	2-147
[:SOURce[<n>]]:PHASe[:ADJust] .....	2-147
[:SOURce[<n>]]:PHASe:INITiate .....	2-148
[:SOURce[<n>]]:FUNCTion[:SHAPe] .....	2-148
[:SOURce[<n>]]:FUNCTion:RAMP:SYMMetry .....	2-149
[:SOURce[<n>]]:VOLTage[:LEVel][:IMMediate][:AMPLitude] .....	2-149
[:SOURce[<n>]]:VOLTage[:LEVel][:IMMediate]:OFFSet .....	2-150
[:SOURce[<n>]]:PULSe:DCYCLE .....	2-150
[:SOURce[<n>]]:MOD:TYPE .....	2-151
[:SOURce[<n>]]:MOD:AM[:DEPTH] .....	2-152
[:SOURce[<n>]]:MOD:AM:INTernal:FREQuency .....	2-152
[:SOURce[<n>]]:MOD:FM:INTernal:FREQuency .....	2-152
[:SOURce[<n>]]:MOD:AM:INTernal:FUNCTion .....	2-153
[:SOURce[<n>]]:MOD:FM:INTernal:FUNCTion .....	2-153
[:SOURce[<n>]]:MOD:FM[:DEVlation] .....	2-154
[:SOURce[<n>]]:SWEep:TYPE .....	2-154
[:SOURce[<n>]]:SWEep:STIME .....	2-155
[:SOURce[<n>]]:SWEep:BTIME .....	2-155
[:SOURce[<n>]]:BURSt:TYPE .....	2-155
[:SOURce[<n>]]:BURSt:CYCLes .....	2-156
[:SOURce[<n>]]:BURSt:DELay .....	2-156
[:SOURce[<n>]]:APPLY? .....	2-157
[:SOURce[<n>]]:APPLY:NOISe .....	2-157
[:SOURce[<n>]]:APPLY:PULSe .....	2-157
[:SOURce[<n>]]:APPLY:RAMP .....	2-157
[:SOURce[<n>]]:APPLY:SINusoid .....	2-157
[:SOURce[<n>]]:APPLY:SQUare .....	2-157
[:SOURce[<n>]]:APPLY:USER .....	2-157
[:SOURce[<n>]]:OUTPut[<n>][:STATe] .....	2-158
[:SOURce[<n>]]:OUTPut[<n>]:IMPedance .....	2-159
:SYSTem Commands .....	2-160
:SYSTem:AOUTput .....	2-161
:SYSTem:AUTClear .....	2-161
:SYSTem:AUTOscale .....	2-161
:SYSTem:BEEPer .....	2-162
:SYSTem:DATE .....	2-162
:SYSTem:ERRor[:NEXT]? .....	2-162
:SYSTem:GAMount? .....	2-162
:SYSTem:RClock .....	2-163
:SYSTem:GPIB .....	2-163
:SYSTem:KEY:PRESSs .....	2-163
:SYSTem:KEY:INCRease .....	2-165
:SYSTem:KEY:DECRease .....	2-165
:SYSTem:LANGUage .....	2-165
:SYSTem:PON .....	2-166
:SYSTem:PSTatus .....	2-166
:SYSTem:OPTion:INSTall .....	2-166
:SYSTem:OPTion:UNINStall .....	2-167
:SYSTem:OPTion:STATUs? .....	2-167
:SYSTem:PWDClear .....	2-168
:SYSTem:RAMount? .....	2-168
:SYSTem:RESet .....	2-168
:SYSTem:SETup .....	2-168
:SYSTem:SSAVER:TIME .....	2-168
:SYSTem:TIME .....	2-169
:SYSTem:LOCKed .....	2-169
:SYSTem:MODules? .....	2-169

:TIMebase Commands .....	2-170
:TIMebase:DELAy:ENABLe .....	2-170
:TIMebase:DELAy:OFFSet .....	2-170
:TIMebase:DELAy:SCALe .....	2-171
:TIMebase[:MAIN]:OFFSet .....	2-171
:TIMebase[:MAIN]:SCALe .....	2-172
:TIMebase:MODE .....	2-172
:TIMebase:HREFerence:MODE .....	2-172
:TIMebase:HREFerence:POSition .....	2-173
:TIMebase:VERNier .....	2-173
:TRIGger Commands .....	2-174
:TRIGger:MODE .....	2-175
:TRIGger:COUPLing .....	2-175
:TRIGger:STATus? .....	2-175
:TRIGger:SWEEp .....	2-176
:TRIGger:HOLDoff .....	2-176
:TRIGger:NREJect .....	2-177
:TRIGger:EDGE .....	2-177
:TRIGger:PULSe .....	2-179
:TRIGger:SLOPe .....	2-181
:TRIGger:VIDeo .....	2-184
:TRIGger:PATtern .....	2-187
:TRIGger:DURation .....	2-189
:TRIGger:TIMeout .....	2-192
:TRIGger:RUNT .....	2-194
:TRIGger:WINDows .....	2-197
:TRIGger:DELAy .....	2-200
:TRIGger:SHOLd .....	2-204
:TRIGger:NEDGE .....	2-208
:TRIGger:RS232 (Option) .....	2-210
:TRIGger:IIC (Option) .....	2-213
:TRIGger:CAN (Option) .....	2-217
:TRIGger:SPI (Option) .....	2-220
:TRIGger:FLEXray (Option) .....	2-225
:TRIGger:IIS (Option) .....	2-227
:TRIGger:LIN (Option) .....	2-231
:TRIGger:M1553 (Option) .....	2-234
:WAVEform Commands .....	2-236
:WAVEform:SOURce .....	2-237
:WAVEform:MODE .....	2-238
:WAVEform:FORMat .....	2-238
:WAVEform:POINts .....	2-239
:WAVEform:DATA? .....	2-239
:WAVEform:XINCrement? .....	2-240
:WAVEform:XORigin? .....	2-240
:WAVEform:XREFerence? .....	2-240
:WAVEform:YINCrement? .....	2-241
:WAVEform:YORigin? .....	2-241
:WAVEform:YREFerence? .....	2-241
:WAVEform:STARt .....	2-242
:WAVEform:STOP .....	2-242
:WAVEform:PREAmble? .....	2-242
<b>Chapter 3 Programming Examples .....</b>	<b>3-1</b>
Programming Preparations .....	3-2
Excel Programming Example .....	3-3
LabVIEW Programming Example .....	3-7
Visual Basic Programming Example .....	3-11
Visual C++ Programming Example .....	3-13



# Chapter 1 SCPI Command Overview

SCPI (Standard Commands for Programmable Instruments) is a standardized instrument programming language that is built upon the existing standard IEEE 488.1 and IEEE 488.2 and conforms to various standards, such as the floating point operation rule in IEEE 754 standard, ISO 646 7-bit coded character set for information interchange (equivalent to ASCII programming). The SCPI commands provide a hierarchical tree structure, and consist of multiple subsystems. Each command subsystem consists of one root keyword and one or more sub-keywords.

Contents in this chapter:

- [Syntax](#)
- [Symbol Description](#)
- [Parameter Type](#)
- [Command Abbreviation](#)

## Syntax

The command line usually starts with a colon; the keywords are separated by colons, and following the keywords are the parameter settings available. The command ending with a quotation mark indicates querying a certain function. The keywords of the command and the first parameter is separated by a space.

For example,

```
:ACQuire:TYPE <type>  
:ACQuire:TYPE?
```

ACQuire is the root keyword of the command, and TYPE is the second-level keyword. The command line starts with a colon, and different levels of keywords are also separated by colons. <type> indicates a settable parameter. The command ending with a quotation mark indicates querying a certain function. The command keywords ":ACQuire:TYPE" and the parameter <type> are separated by a space.

In some commands with parameters, "," is often used to separate multiple parameters. For example, :SYSTem:DATE <year>,<month>,<day>.

## Symbol Description

The following symbols are not sent with the commands.

- 1. Braces { }**  
The contents enclosed in the braces are parameter options. Parameters are usually separated by the vertical bar "|". When using the command, you must select one of the parameters.
- 2. Vertical Bar |**  
The vertical bar is used to separate multiple parameters. When using the command, you must select one of the parameters.
- 3. Square Brackets [ ]**  
The contents in the square brackets can be omitted.
- 4. Angle Brackets < >**  
The parameter enclosed in the angle brackets must be replaced by an effective value.

## Parameter Type

### 1. Bool

The parameter can be set to ON, OFF, 1, or 0. For example,

```
:SYSTem:BEEPer <bool>
```

```
:SYSTem:BEEPer?
```

Wherein,

<bool> can be set to `{{1|ON}|{0|OFF}}`.

The query returns 1 or 0.

### 2. Discrete

The parameter can be any of the values listed. For example,

```
:ACQuire:TYPE <type>
```

```
:ACQuire:TYPE?
```

Wherein,

<type> can be set to NORMAL, AVERages, or PEAK.

The query returns NORM, AVER, or PEAK.

### 3. Integer

Unless otherwise specified, the parameter can be any integer (NR1 format) within the effective value range.

**Note:** Do not set the parameter to a decimal, otherwise, errors will occur.

For example,

```
:DISPlay:GBRightness <brightness>
```

```
:DISPlay:GBRightness?
```

Wherein, <brightness> can be set to an integer ranging from 1 to 100.

The query returns an integer ranging from 1 to 100.

### 4. Real

The parameter can be any real number within the effective value range, and this command accepts parameter input in decimal (NR2 format) and scientific notation (NR3 format). For example,

```
:TRIGger:TIMEout:TIME <time>
```

```
:TRIGger:TIMEout:TIME?
```

Wherein, <time> can be set to any real number ranging from 1.6E-8 (i.g. 16 ns) to 1E+1 (i.g. 10 s).

The query returns a real number in scientific notation.

### 5. ASCII String

The parameter can be the combinations of ASCII characters.

For example,

```
:SYSTem:OPTion:INSTall <license>
```

Wherein, <license> can be set to

```
MSO8000-PWR@3AEBC07E6C31F82B78A1C401DC2E3AC2CC9431B57F60D1E1CB712F8682C93609A6  
05F8577BFDE920373062BE226289A27C134E2C91BF80CB00F8011AC181FD40.
```

## Command Abbreviation

All the commands are case-insensitive. They can all be in upper case or in lower case. If abbreviation is used, you must input all the capital letters in the command. For example,

```
:DISPlay:GBRightness?
```

can be abbreviated as

```
:DISP:GBR?
```

## Chapter 2 Command System

This chapter introduces the syntax, functions, parameters, and usage of each MSO8000 command. For this oscilloscope, only CH1 is enabled by default.

### Contents in this chapter:

- ◆ [:AUToscale](#)
- ◆ [:CLEAr](#)
- ◆ [:RUN](#)
- ◆ [:STOP](#)
- ◆ [:SINGle](#)
- ◆ [:TFORce](#)
- ◆ [:ACQuire Commands](#)
- ◆ [:BUS<n> Commands](#)
- ◆ [:CHANnel<n> Commands](#)
- ◆ [:CLOCK Commands](#)
- ◆ [:COUNter Commands](#)
- ◆ [:CURSor Commands](#)
- ◆ [:DISPlay Commands](#)
- ◆ [:DVM Commands](#)
- ◆ [:EYE Commands](#)
- ◆ [:HISTogram Commands](#)
- ◆ [IEEE488.2 Common Commands](#)
- ◆ [:JITTer Commands](#)
- ◆ [:LA Commands](#)
- ◆ [:LAN Commands](#)
- ◆ [:MASK Commands](#)
- ◆ [:MATH<n> Commands](#)
- ◆ [:MEASure Commands](#)
- ◆ [:POWER Commands](#)
- ◆ [:Quick Command](#)
- ◆ [:RECORD Commands](#)
- ◆ [:REFerence Commands](#)
- ◆ [:SAVE and :Load Commands](#)
- ◆ [:SEARCh Commands](#)
- ◆ [\[:SOURce\[<n>\]\] Commands](#)
- ◆ [:SYSTem Commands](#)
- ◆ [:TIMEbase Commands](#)
- ◆ [:TRIGger Commands](#)

◆ [:WAVEform Commands](#)

**Note:**

1. Unless otherwise specified, the descriptions in this manual all take MSO8104 as an example.
2. For the parameter setting command (time, frequency, amplitude, etc.), the digital oscilloscope can only recognize the numbers, unable to recognize the unit sent together with them. The unit of the parameter is a default one. For the default units of various parameters, refer to the descriptions for the specified command.

## :AUToscale

**Syntax** :AUToscale

**Description** Enables the waveform auto setting function. The oscilloscope will automatically adjust the vertical scale, horizontal time base, and trigger mode according to the input signal to realize optimal waveform display. This command functions the same as the **AUTO** key on the front panel.

- Remarks**
- When the AUTO function is disabled, this command is invalid. For details, refer to :SYSTem:AUToscale.
  - When the pass/fail test is enabled, the AUTO function runs normally, but the pass/fail test function is forced to be disabled.
  - When the waveform recording function is enabled or the recorded waveforms are played back, the AUTO function runs normally, but the recording or playing function is forced to be disabled.

## :CLEar

**Syntax** :CLEar

**Description** Clears all the waveforms on the screen. This command functions the same as the **CLEAR** key on the front panel.

## :RUN

## :STOP

**Syntax** :RUN  
:STOP

**Description** The :RUN command starts the oscilloscope and the :STOP command stops the oscilloscope. This command functions the same as the **RUN/STOP** key on the front panel.

- Remarks** When the waveform recording function is enabled, the **RUN/STOP** key on the front panel is disabled.



## :SINGle

**Syntax** :SINGle

**Description** Sets the trigger mode of the oscilloscope to "Single". This command functions the same as either of the following two operation: press **SINGLE** on the front panel; or send the [:TRIGger:SWEEp SINGLE](#) command.

- Remarks**
- In the single trigger mode, the oscilloscope performs a single trigger when the trigger conditions are met and then it stops.
  - When the waveform recording function is enabled or the recorded waveforms are played back, this command is invalid.
  - For the single trigger, you can use the [:TFORce](#) command to generate one trigger by force.

## :TFORce

**Syntax** :TFORce

**Description** Generates a trigger signal forcibly. This command is only applicable to the normal and single trigger modes (refer to the [:TRIGger:SWEEp](#) command). This command functions the same as the **FORCE** key in the trigger control area of the front panel.

## :ACQUIRE Commands

The :ACQUIRE commands are used to set the memory depth of the oscilloscope, the acquisition mode, the average times, as well as query the current sample rate.

### Command List<sup>[1]</sup>:

- ◆ [:ACQUIRE:AVERAGES](#)
- ◆ [:ACQUIRE:MDEPTH](#)
- ◆ [:ACQUIRE:TYPE](#)
- ◆ [:ACQUIRE:SRATE?](#)
- ◆ [:ACQUIRE:LA:SRATE?](#)
- ◆ [:ACQUIRE:AALIAS](#)

**Note<sup>[1]</sup>:** In the "Command List" in this manual, the query commands and the parameters in the setting commands are omitted. You can refer to the complete introductions of the commands in the body of the text based on the keywords listed here.

## :ACQUIRE:AVERAGES

**Syntax** :ACQUIRE:AVERAGES <count>

:ACQUIRE:AVERAGES?

**Description** Sets or queries the number of averages in the average acquisition mode.

### Parameter

Name	Type	Range	Default
<count>	Integer	2 <sup>n</sup> (n is an integer, and its range is from 1 to 16)	2

### Remarks

- You can send the [:ACQUIRE:TYPE](#) command to set the acquisition mode.
- In the average acquisition mode, greater number of averages can lower the noise and increase the vertical resolution; but will also slow the response of the displayed waveform to the waveform changes.

### Return Format

The query returns an integer ranging from 2 to 65536.

### Example

```
:ACQUIRE:AVERAGES 128 /*Sets the average times to 128.*/
:ACQUIRE:AVERAGES? /*The query returns 128.*/
```

## :ACQUIRE:MDEPTH

**Syntax** :ACQUIRE:MDEPTH <mdep>

:ACQUIRE:MDEPTH?

**Description** Sets or queries the memory depth of the oscilloscope (i.g. the number of waveform points that can be stored through the sampling in a single trigger). The default unit is pts.

### Parameter

Name	Type	Range	Default
<mdep>	Discrete	{AUTO 1k 10k 100k 1M 10M 25M 50M 100M 125M 250M 500M 1000 10000 100000 1000000 10000000 25000000 50000000 100000000 125000000 250000000 500000000 1e3 1e4 1e5 1e6 1e7 2.5e7 5e7 1e8 1.25e8 2.5e8 5e8}	AUTO

- Remarks**
- When "AUTO" is selected, the oscilloscope selects the memory depth automatically according to the current sample rate.
  - The maximum memory depth for the single channel is 500 M; the maximum memory depth for the dual-channel is 250 M; and the maximum memory depth for the four-channel is 125 M.

**Return Format** The query returns the memory depth in scientific notation.

**Example** :ACQUIRE:MDEPTH 1M /\*Sets the memory depth to 1M.\*/  
:ACQUIRE:MDEPTH? /\*The query returns 1.000000E+6.\*/\*

## :ACQUIRE:TYPE

**Syntax** :ACQUIRE:TYPE <type>

:ACQUIRE:TYPE?

**Description** Sets or queries the acquisition mode of the oscilloscope.

Parameter	Name	Type	Range	Default
	<type>	Discrete	{NORMAL AVERAGES PEAK HRESOLUTION}	NORMAL

- Remarks**
- **NORMAL:** In this mode, the oscilloscope samples the signal at a specified fixed time interval to rebuild the waveform. For most of the waveforms, using this mode can produce the optimal display effects.
  - **AVERAGES:** In this mode, the oscilloscope averages the waveforms from multiple samples to reduce the random noise of the input signal and improve the vertical resolution. Greater number of averages can lower the noise and increase the vertical resolution; while at the same time, it will slow the response of the displayed waveform to the waveform changes.
  - **PEAK:** indicates the peak detection. In this mode, the oscilloscope samples the maximum and minimum value of the signal at the fixed sampling interval to acquire the signal envelope or the narrow pulses that might be lost. In this mode, signal aliasing can be prevented, but the noise displayed would be larger.
  - **HRESOLUTION:** the oscilloscope averages the neighbouring points of the sampled waveform to reduce the random noise on the input signal and display smoother waveform on the screen. This mode is usually used when the sample rate of the digital converter is greater than the storage rate of the sample storage.

**Return Format** The query returns NORM, AVER, PEAK, or HRES.

**Example** :ACQUIRE:TYPE AVERAGES /\*Sets the acquisition mode to AVERAGES.\*/  
:ACQUIRE:TYPE? /\*The query returns AVER.\*/\*

**:ACQUIRE:SRATE?**

**Syntax** :ACQUIRE:SRATE?

**Description** Queries the current sample rate. The default unit is Sa/s.

- Remarks**
- Sample rate indicates the frequency of the signal sampling, i.g. the number of waveform points sampled per second.
  - The formula below describes the relationship among sample rate, memory depth, and waveform length:  

$$\text{memory depth} = \text{sample rate} \times \text{waveform length}$$
 Wherein, the memory depth is set by the [:ACQUIRE:MDEPTH](#) command. The waveform length is obtained by multiplying the horizontal time base (set by the [:TIMEBASE\[:MAIN\]:SCALE](#) command) by the number of grids in the horizontal direction. For MSO8000, the number of grids in the horizontal direction is 10.

**Return Format** The query returns the sample rate in scientific notation.

**Example** :ACQUIRE:SRATE? /\*The query returns 2.500000E+9.\*/

**:ACQUIRE:LA:SRATE?**

**Syntax** :ACQUIRE:LA:SRATE?

**Description** Queries the current LA sample rate. The default unit is Sa/s.

**Return Format** The query returns the sample rate in scientific notation.

**Example** :ACQUIRE:LA:SRATE? /\*The query returns 1.250000E+9.\*/

**:ACQUIRE:LA:MDEPTH?**

**Syntax** :ACQUIRE:LA:MDEPTH?

**Description** Queries the current LA memory depth.

**Return Format** The query returns the memory depth in scientific notation.

**Example** :ACQUIRE:LA:MDEPTH? /\*The query returns 1.250000E+4.\*/

**:ACQUIRE:AALIAS**

**Syntax** :ACQUIRE:AALIAS <bool>  
:ACQUIRE:AALIAS?

**Description** Enables or disables the anti-aliasing function of the oscilloscope; or queries the on/off status of the anti-aliasing function.

Parameter	Name	Type	Range	Default
	<bool>	Bool	{{1 ON}} {{0 OFF}}	0 OFF

**Return Format** The query returns 1 or 0.

**Example** :ACQUIRE:AALIAS ON /\*Enables the anti-aliasing function.\*/  
:ACQUIRE:AALIAS? /\*The query returns 1.\*/

## :BUS<n> Commands

The :BUS<n> commands are used to execute the decoding-related settings and operations.

### Command List:

- ◆ [:BUS<n>:MODE](#)
- ◆ [:BUS<n>:DISPlay](#)
- ◆ [:BUS<n>:FORMat](#)
- ◆ [:BUS<n>:EVENT](#)
- ◆ [:BUS<n>:EVENT:FORMat](#)
- ◆ [:BUS<n>:EVENT:VIEW](#)
- ◆ [:BUS<n>:LABel](#)
- ◆ [:BUS<n>:DATA?](#)
- ◆ [:BUS<n>:EEXPort](#)
- ◆ [:BUS<n>:POSition](#)
- ◆ [:BUS<n>:THReshold](#)
- ◆ [:BUS<n>:PARAllel](#)
- ◆ [:BUS<n>:RS232 \(Option\)](#)
- ◆ [:BUS<n>:IIC \(Option\)](#)
- ◆ [:BUS<n>:SPI \(Option\)](#)
- ◆ [:BUS<n>:CAN \(Option\)](#)
- ◆ [:BUS<n>:FLEXray \(Option\)](#)
- ◆ [:BUS<n>:LIN \(Option\)](#)
- ◆ [:BUS<n>:IIS \(Option\)](#)
- ◆ [:BUS<n>:M1553 \(Option\)](#)

### :BUS<n>:MODE

**Syntax** :BUS<n>:MODE <mode>

:BUS<n>:MODE?

**Description** Sets or queries the decoding type of the specified decoding bus.

Parameter	Name	Type	Range	Default
	<n>	Discrete	{1 2 3 4}	---
	<mode>	Discrete	{PARAllel RS232 SPI IIC IIS LIN CAN FLEXray M1553}	PARAllel

**Remarks** Except PARAllel, all the other decodings are options. Only when the specified option is installed, can the command is available.

**Return Format** The query returns PAR, RS232, SPI, IIC, IIS, LIN, CAN, FLEX, or M1553.

**Example** :BUS1:MODE SPI /\*Sets the type of the decoding bus to SPI.\*/  
:BUS1:MODE? /\*The query returns SPI.\*/

**:BUS<n>:DISPlay****Syntax** :BUS<n>:DISPlay <bool>

:BUS&lt;n&gt;:DISPlay?

**Description** Enables or disables the specified decoding bus; or queries the on/off display status of the specified decoding bus.

Parameter	Name	Type	Range	Default
	<n>	Discrete	{1 2 3 4}	---
	<bool>	Bool	{{1 ON} {0 OFF}}	0 OFF

**Return Format** The query returns 1 or 0.

**Example** :BUS1:DISPlay ON /\*Enables the decoding bus.\*/  
 :BUS1:DISPlay? /\*The query returns 1.\*/\*

**:BUS<n>:FORMat****Syntax** :BUS<n>:FORMat <fmt>

:BUS&lt;n&gt;:FORMat?

**Description** Sets or queries the display format of decoding data of the specified decoding bus.

Parameter	Name	Type	Range	Default
	<n>	Discrete	{1 2 3 4}	---
	<fmt>	Discrete	{HEX ASCii DEC BIN}	ASCii

**Remarks** HEX indicates Hexadecimal; DEC indicates Decimal; BIN indicates Binary.**Return Format** The query returns HEX, ASC, DEC, or BIN.

**Example** :BUS1:FORMat HEX /\*Sets the display format of the bus to HEX.\*/  
 :BUS1:FORMat? /\*The query returns HEX.\*/\*

**:BUS<n>:EVENT****Syntax** :BUS<n>:EVENT <bool>

:BUS&lt;n&gt;:EVENT?

**Description** Enables or disables the event table of the specified decoding bus; or queries the on/off status of the specified decoding bus event table.

Parameter	Name	Type	Range	Default
	<n>	Discrete	{1 2 3 4}	---
	<bool>	Bool	{{1 ON} {0 OFF}}	0 OFF

**Remarks** Before using the command, enable the specified decoding bus.**Return Format** The query returns 1 or 0.

**Example** :BUS1:EVENT ON /\*Enables the event table of the specified decoding bus.\*/  
 :BUS1:EVENT? /\*The query returns 1.\*/\*

**:BUS<n>:EVENT:FORMat**

**Syntax** :BUS<n>:EVENT:FORMat <format>

:BUS<n>:EVENT:FORMat?

**Description** Sets or queries the display format of the specified decoding bus event table.

**Parameter**

Name	Type	Range	Default
<n>	Discrete	{1 2 3 4}	---
<format>	Discrete	{HEX AScii DEC BIN}	AScii

**Remarks** HEX indicates Hexadecimal; DEC indicates Decimal; BIN indicates Binary.

**Return Format** The query returns HEX, ASC, DEC, or BIN.

**Example** :BUS1:EVENT:FORMat HEX

/\*Sets the display format of the specified decoding bus event table to HEX.\*/

:BUS1:EVENT:FORMat? /\*The query returns HEX.\*/

**:BUS<n>:EVENT:VIEW**

**Syntax** :BUS<n>:EVENT:VIEW <packet>

:BUS<n>:EVENT:VIEW?

**Description** Sets or queries the data page of the specified decoding bus event table.

**Parameter**

Name	Type	Range	Default
<n>	Discrete	{1 2 3 4}	---
<packet>	Discrete	{PACKets DEtails PAYLoad}	PACKets

**Remarks**

- PACKets: displays time, data, and error information in the specified event table.
- DETails: displays the detailed data of the specified row in the event table.
- PAYLoad: displays all the data of the specified column in the event table.
- When different views are selected, the export format of the data list will be changed accordingly.

**Return Format** The query returns PACK, DET, or PAYL.

**Example** :BUS1:EVENT:VIEW DETails /\*Sets the data page of the decoding bus event table to DETails.\*/

:BUS1:EVENT:VIEW? /\*The query returns DET.\*/

**:BUS<n>:LABel**

**Syntax** :BUS<n>:LABel <bool>

:BUS<n>:LABel?

**Description** Enables or disables the label of the specified decoding bus; or queries the on/off status of the label of the specified decoding bus.

Parameter	Name	Type	Range	Default
	<n>	Discrete	{1 2 3 4}	---
	<bool>	Bool	{{1 ON} {0 OFF}}	0 OFF

**Remarks** Before using the command, enable the specified decoding bus.

**Return Format** The query returns 1 or 0.

**Example** :BUS1:LABel ON /\*Enables the label of the specified decoding bus.\*/  
:BUS1:LABel? /\*The query returns 1.\*/\*

## :BUS<n>:DATA?

**Syntax** :BUS<n>:DATA?

**Description** Reads the data in the decoding event table.

Parameter	Name	Type	Range	Default
	<n>	Discrete	{1 2 3 4}	---

**Return Format** The query returns the data in the decoding event table with the following formats.  
#9000000072PAL,  
Time,Data,,  
-1us,0,,  
-990.3ns,1,,  
-503.2ns,0,,  
9.2ns,1,,  
497.2ns,0,

Wherein, "#9000000072" is the TMC data block header, which is followed by the data in the event table. The 9-digit data following #9 in the data block header indicates the number of bytes of the effective data. "PAL" indicates the decoding type. The available decoding type can also be RS232, I2C, SPI, or CAN. The data are separated by commas, and will automatically go to the next line according to the line length limit in the decoding list. The data value is related to the numeral system that you have set.

**Note:** You can save all the data (except TMC data block header and decoding type, e.g. #9000000072PAL) as the "\*.csv" file and view the data in the form of a list.

## :BUS<n>:EEXPort

**Syntax** :BUS<n>:EEXPort

**Description** Exports the decoding information in the specified decoding bus event table in CSV form.

Parameter	Name	Type	Range	Default
	<n>	Discrete	{1 2 3 4}	---

**Example** :BUS1:EEXPort C:/123.csv  
/\*Exports the decoding information in the bus event table to the local Disk C,  
with the filename 123.csv.\*/\*



**:BUS<n>:POsition**

**Syntax** :BUS<n>:POsition <pos>

:BUS<n>:POsition?

**Description** Sets or queries the vertical position of the bus on the screen.

**Parameter**

Name	Type	Range	Default
<n>	Discrete	{1 2 3 4}	---
<pos>	Integer	-167 to +217	Related to the channel offset

**Return Format** The query returns an integer ranging from -167 to +217.

**Example** :BUS1:POsition 200 /\*Sets the vertical position of the bus to 200.\*/  
:BUS1:POsition? /\*The query returns 200.\*/\*

**:BUS<n>:THReshold**

**Syntax** :BUS<n>:THReshold <value>,<type>

:BUS<n>:THReshold? <type>

**Description** Sets or queries the threshold of the specified decoding source.

**Parameter**

Name	Type	Range	Default
<n>	Discrete	{1 2 3 4}	---
<value>	Real	(-5×VerticalScale-OFFSet) to (5×VerticalScale-OFFSet)	0
<type>	Discrete	{PAL TX RX SCL SDA CS CLK MISO MOSI LIN CAN CANSUB1}	---

- Remarks**
- For VerticalScale, refer to the [:CHANnel<n>:SCALE](#) command. For OFFSet, refer to the [:CHANnel<n>:OFFSet](#) command.
  - For RS232 decoding, only when the Rx source is enabled, can you set the threshold.
  - For SPI decoding, only when the MOSI source is enabled, can you set the threshold.

**Return Format** The query returns the threshold of the specified decoding source in scientific notation.

**Example** :BUS1:THReshold 2.4,PAL /\*Sets the threshold of the PAL decoding source to 2.4 V.\*/  
:BUS1:THReshold? PAL /\*The query returns 2.400000E0.\*/\*

## :BUS<n>:PARAllel

The :BUS<n>:PARAllel commands are used to set relevant parameters for Parallel decoding.

### Command List:

- ◆ [:BUS<n>:PARAllel:CLK](#)
- ◆ [:BUS<n>:PARAllel:SLOPe](#)
- ◆ [:BUS<n>:PARAllel:WIDTh](#)
- ◆ [:BUS<n>:PARAllel:BITX](#)
- ◆ [:BUS<n>:PARAllel:SOURce](#)
- ◆ [:BUS<n>:PARAllel:POLarity](#)
- ◆ [:BUS<n>:PARAllel:NREJect](#)
- ◆ [:BUS<n>:PARAllel:NRTIME](#)

### :BUS<n>:PARAllel:CLK

**Syntax** :BUS<n>:PARAllel:CLK <source>

:BUS<n>:PARAllel:CLK?

**Description** Sets or queries the clock source of the Parallel decoding.

Parameter	Name	Type	Range	Default
	<n>	Discrete	{1 2 3 4}	---
	<source>	Discrete	{D0 D1 D2 D3 D4 D5 D6 D7 D8  D9 D10 D11 D12 D13 D14 D15  CHANnel1 CHANnel2 CHANnel3 CHANnel4  OFF}	OFF

**Return Format** The query returns D0, D1, D2, D3, D4, D5, D6, D7, D8, D9, D10, D11, D12, D13, D14, D15, CHAN1, CHAN2, CHAN3, CHAN4, or OFF.

**Example** :BUS1:PARAllel:CLK D0 /\*Sets the clock source of the Parallel decoding to D0.\*/  
:BUS1:PARAllel:CLK? /\*The query returns D0.\*/\*

### :BUS<n>:PARAllel:SLOPe

**Syntax** :BUS<n>:PARAllel:SLOPe <slope>

:BUS<n>:PARAllel:SLOPe?

**Description** Sets or queries the edge type of the clock channel when being sampled by Parallel decoding on the data channel.

Parameter	Name	Type	Range	Default
	<n>	Discrete	{1 2 3 4}	---
	<slope>	Discrete	{POSitive NEGative BOTH}	POSitive

**Remarks** If no clock channel is selected, the instrument will sample when the channel data jumps during the decoding.

**Return Format** The query returns POS, NEG, or BOTH.

**Example** :BUS1:PARAllel:SLOPe BOTH /\*Sets the Parallel decoding to sample on any edge of the clock channel.\*/  
 :BUS1:PARAllel:SLOPe? /\*The query returns BOTH.\*/\*

### :BUS<n>:PARAllel:WIDTh

**Syntax** :BUS<n>:PARAllel:WIDTh <wid>  
 :BUS<n>:PARAllel:WIDTh?

**Description** Sets or queries the data width of the parallel bus, i.g. the number of bits per frame.

Parameter	Name	Type	Range	Default
	<n>	Discrete	{1 2 3 4}	---
	<wid>	Integer	0 to 20	1

- Remarks**
- After you send this command to set the data width of the bus, send the [:BUS<n>:PARAllel:BITX](#) and [:BUS<n>:PARAllel:SOURce](#) command to select the bit respectively and set the channel source for the bit.
  - Only when the bus source is set to User, can this command be valid.

**Return Format** The query returns an integer ranging from 0 to 20.

**Example** :BUS1:PARAllel:WIDTh 16 /\*Sets the data width of Parallel decoding to 16.\*/  
 :BUS1:PARAllel:WIDTh? /\*The query returns 16.\*/\*

### :BUS<n>:PARAllel:BITX

**Syntax** :BUS<n>:PARAllel:BITX <bit>  
 :BUS<n>:PARAllel:BITX?

**Description** Sets or queries the data bit that the parallel bus requires to set for the channel source.

Parameter	Name	Type	Range	Default
	<n>	Discrete	{1 2 3 4}	---
	<bit>	Integer	0 to (data width - 1)	0

- Remarks**
- The data width is set by the [:BUS<n>:PARAllel:WIDTh](#) command.
  - After selecting the desired bit, send the [:BUS<n>:PARAllel:SOURce](#) command to set the channel source for the bit.
  - The data bit should be smaller than or equal to the data width.

**Return Format** The query returns the current data bits in integer. Its unit is Hz.

**Example** :BUS1:PARAllel:BITX 2 /\*Sets the current bit to 2.\*/  
 :BUS1:PARAllel:BITX? /\*The query returns 2.\*/\*

**:BUS<n>:PARAllel:SOURce**

**Syntax** :BUS<n>:PARAllel:SOURce <src>  
:BUS<n>:PARAllel:SOURce?

**Description** Sets or queries the channel source of the currently selected data bit.

Parameter	Name	Type	Range	Default
	<n>	Discrete	{1 2 3 4}	---
	<src>	Discrete	{D0 D1 D2 D3 D4 D5 D6 D7 D8 D9 D10 D11 D12 D13 D14 D15 CHANnel1 CHANnel2 CHANnel3 CHANnel4}	Related to the selected bit

**Remarks** Before sending this command, send the [:BUS<n>:PARAllel:BITX](#) command to select the desired data bit.

**Return Format** The query returns D0, D1, D2, D3, D4, D5, D6, D7, D8, D9, D10, D11, D12, D13, D14, D15, CHAN1, CHAN2, CHAN3, or CHAN4.

**Example** :BUS1:PARAllel:SOURce CHANnel2 /\*Sets the channel source of the current bit to CHANnel2.\*/  
:BUS1:PARAllel:SOURce? /\*The query returns CHAN2.\*/\*

**:BUS<n>:PARAllel:POLarity**

**Syntax** :BUS<n>:PARAllel:POLarity <pol>  
:BUS<n>:PARAllel:POLarity?

**Description** Sets or queries the data polarity of Parallel decoding.

Parameter	Name	Type	Range	Default
	<n>	Discrete	{1 2 3 4}	---
	<pol>	Discrete	{NEGative POSitive}	POSitive

**Remarks** ➤ NEGative: indicates the negative polarity.  
➤ POSitive: indicates the positive polarity.

**Return Format** The query returns NEG or POS.

**Example** :BUS1:PARAllel:POLarity NEGative /\*Sets the data polarity of Parallel decoding to NEGative.\*/  
:BUS1:PARAllel:POLarity? /\*The query returns NEG.\*/\*

**:BUS<n>:PARAllel:NREJect**

**Syntax** :BUS<n>:PARAllel:NREJect <bool>  
:BUS<n>:PARAllel:NREJect?

**Description** Enables or disables the noise rejection function of Parallel decoding; or queries the status of the noise rejection function of Parallel decoding.

Parameter	Name	Type	Range	Default
	<n>	Discrete	{1 2 3 4}	---
	<bool>	Bool	{{1 ON} {0 OFF}}	0 OFF

- Remarks**
- Noise rejection can remove the data that last not enough time on the bus and eliminate the burst glitch in the actual circuit.
  - When the noise rejection is enabled, send the [:BUS<n>:PARAllel:NRTIME](#) command to set the required rejection time.

**Return Format** The query returns 1 or 0.

**Example** :BUS1:PARAllel:NREJect ON /\*Enables the noise rejection function.\*/  
:BUS1:PARAllel:NREJect? /\*The query returns 1.\*/\*

### :BUS<n>:PARAllel:NRTIME

**Syntax** :BUS<n>:PARAllel:NRTIME <time>  
:BUS<n>:PARAllel:NRTIME?

**Description** Sets or queries the noise rejection time of Parallel decoding. The default unit is s.

Parameter	Name	Type	Range	Default
	<n>	Discrete	{1 2 3 4}	---
	<time>	Real	0 ns to 1 s	0.00 s

**Return Format** The query returns the noise rejection time in scientific notation.

**Example** :BUS1:PARAllel:NRTIME 0.01 /\*Sets the noise rejection time to 10 ms.\*/  
:BUS1:PARAllel:NRTIME? /\*The query returns 1.000000E-2.\*/\*

## :BUS<n>:RS232 (Option)

The :BUS<n>:RS232 commands are used to set relevant parameters for RS232 decoding.

### Command List:

- ◆ [:BUS<n>:RS232:TX](#)
- ◆ [:BUS<n>:RS232:RX](#)
- ◆ [:BUS<n>:RS232:POLarity](#)
- ◆ [:BUS<n>:RS232:ENDian](#)
- ◆ [:BUS<n>:RS232:BAUD](#)
- ◆ [:BUS<n>:RS232:DBITs](#)
- ◆ [:BUS<n>:RS232:SBITs](#)
- ◆ [:BUS<n>:RS232:PARity](#)
- ◆ [:BUS<n>:RS232:PACKet](#)
- ◆ [:BUS<n>:RS232:PEND](#)

### :BUS<n>:RS232:TX

**Syntax** :BUS<n>:RS232:TX <source>

:BUS<n>:RS232:TX?

**Description** Sets or queries the TX channel source of RS232 decoding.

Parameter	Name	Type	Range	Default
	<n>	Discrete	{1 2 3 4}	---
	<source>	Discrete	{D0 D1 D2 D3 D4 D5 D6 D7 D8  D9 D10 D11 D12 D13 D14 D15  CHANnel1 CHANnel2 CHANnel3 CHANnel4 OFF}	OFF

**Return Format** The query returns D0, D1, D2, D3, D4, D5, D6, D7, D8, D9, D10, D11, D12, D13, D14, D15, CHAN1, CHAN2, CHAN3, CHAN4, or OFF.

**Example** :BUS1:RS232:TX D0 /\*Sets the TX channel source of RS232 decoding to D0.\*/  
:BUS1:RS232:TX? /\*The query returns D0.\*/\*

### :BUS<n>:RS232:RX

**Syntax** :BUS<n>:RS232:RX <source>

:BUS<n>:RS232:RX?

**Description** Sets or queries the RX channel source of RS232 decoding.

Parameter	Name	Type	Range	Default
	<n>	Discrete	{1 2 3 4}	---
	<source>	Discrete	{D0 D1 D2 D3 D4 D5 D6 D7 D8  D9 D10 D11 D12 D13 D14 D15  CHANnel1 CHANnel2 CHANnel3 CHANnel4 OFF}	OFF

**Return** The query returns D0, D1, D2, D3, D4, D5, D6, D7, D8, D9, D10, D11, D12, D13, D14,

**Format** D15, CHAN1, CHAN2, CHAN3, CHAN4, or OFF.

**Example** :BUS1:RS232:RX D0 /\*Sets the RX channel source of RS232 decoding to D0.\*/  
:BUS1:RS232:RX? /\*The query returns D0.\*/

### :BUS<n>:RS232:POLarity

**Syntax** :BUS<n>:RS232:POLarity <pol>  
:BUS<n>:RS232:POLarity?

**Description** Sets or queries the polarity of RS232 decoding.

Parameter	Name	Type	Range	Default
	<n>	Discrete	{1 2 3 4}	---
	<pol>	Discrete	{POSitive NEGative}	NEGative

- Remarks**
- The RS232 standard uses "Negative Logic", i.g. high level is Logic 0 and low level is Logic 1. Therefore, when the parameter <pol> is set to NEGative, it indicates that the polarity is set to negative logic, i.g. Normal polarity. When the parameter <pol> is set to POSitive, it indicates that the polarity is set to positive logic, i.g. Inverted polarity.
  - In the RS232 decoding, the start bit of data packet indicates when to start data transmission. It is determined by the polarity. When <pol> is set to "POSitive", the start bit is 0; when "NEGative", the start bit is 1.

**Return Format** The query returns POS or NEG.

**Example** :BUS1:RS232:POLarity POSitive /\*Sets the polarity of RS232 decoding to POSitive.\*/  
:BUS1:RS232:POLarity? /\*The query returns POS.\*/

### :BUS<n>:RS232:ENDian

**Syntax** :BUS<n>:RS232:ENDian <endian>  
:BUS<n>:RS232:ENDian?

**Description** Sets or queries the endian of data transmission in RS232 decoding.

Parameter	Name	Type	Range	Default
	<n>	Discrete	{1 2 3 4}	---
	<endian>	Discrete	{MSB LSB}	LSB

- Remarks**
- LSB: indicates Least Significant Bit transmission sequence, i.g. the lowest bit of the data is transmitted first.
  - MSB: indicates Most Significant Bit transmission sequence, i.g. the highest bit of the data is transmitted first.

**Return Format** The query returns LSB or MSB.

**Example** :BUS1:RS232:ENDian MSB /\*Sets the transmission order of RS232 decoding to MSB.\*/  
:BUS1:RS232:ENDian? /\*The query returns MSB.\*/

**:BUS<n>:RS232:BAUD**

**Syntax** :BUS<n>:RS232:BAUD <baud>

:BUS<n>:RS232:BAUD?

**Description** Sets or queries the baud rate of data transmission in RS232 decoding. The default unit is bps.

Parameter	Name	Type	Range	Default
	<n>	Discrete	{1 2 3 4}	---
	<baud>	Integer	1 bps to 20 Mbps	9600 bps

**Remarks** If the baud rate is set to a value with "M", then "A" should be added at the end of the value. For example, if you send 5 M, you need to send 5 MA.

**Return Format** The query returns an integer ranging from 1 bps to 20 Mbps.

**Example** :BUS1:RS232:BAUD 4800 /\*Sets the baud rate of data transmission in RS232 decoding to 4800 bps.\*  
:BUS1:RS232:BAUD? /\*The query returns 4800.\*

**:BUS<n>:RS232:DBITs**

**Syntax** :BUS<n>:RS232:DBITs <bits>

:BUS<n>:RS232:DBITs?

**Description** Sets or queries the data width of RS232 decoding.

Parameter	Name	Type	Range	Default
	<n>	Discrete	{1 2 3 4}	---
	<bits>	Discrete	{5 6 7 8 9}	8

**Return Format** The query returns 5, 6, 7, 8, or 9.

**Example** :BUS1:RS232:DBITs 7 /\*Sets the data width of RS232 decoding to 7.\*  
:BUS1:RS232:DBITs? /\*The query returns 7.\*

**:BUS<n>:RS232:SBITs**

**Syntax** :BUS<n>:RS232:SBITs <stop bits>

:BUS<n>:RS232:SBITs?

**Description** Sets or queries the stop bits of each frame of data in RS232 decoding.

Parameter	Name	Type	Range	Default
	<n>	Discrete	{1 2 3 4}	---
	<stop bits>	Discrete	{1 1.5 2}	1

**Return Format** The query returns 1, 1.5, or 2.

**Example** :BUS1:RS232:SBITs 2 /\*Sets the stop bits of RS232 decoding to 2.\*  
:BUS1:RS232:SBITs? /\*The query returns 2.\*



**:BUS<n>:RS232:PARity**

**Syntax** :BUS<n>:RS232:PARity <parity>

:BUS<n>:RS232:PARity?

**Description** Sets or queries the odd-even check mode of data transmission in RS232 decoding.

Parameter	Name	Type	Range	Default
	<n>	Discrete	{1 2 3 4}	---
	<parity>	Discrete	{NONE ODD EVEN}	NONE

- Remarks**
- NONE: indicates that there is no parity bit in data transmission.
  - ODD: indicates the odd parity bit. The total count of occurrences of 1 in the data bit and check bit is an odd number. For example, when 0x55 (01010101) is sent, "1" should be added to the check bit.
  - EVEN: indicates the even parity bit. The total count of occurrences of 1 in the data bit and check bit is an even number. For example, when 0x55 (01010101) is sent, "0" should be added to the check bit.

**Return Format** The query returns NONE, ODD, or EVEN.

**Example** :BUS1:RS232:PARity ODD /\*Sets the odd-even check mode of data transmission in RS232 decoding to ODD.\*/  
 :BUS1:RS232:PARity? /\*The query returns ODD.\*/

**:BUS<n>:RS232:PACKet**

**Syntax** :BUS<n>:RS232:PACKet <bool>

:BUS<n>:RS232:PACKet?

**Description** Enables or disables the packet end during data transmission; or queries the status of packet end during data transmission.

Parameter	Name	Type	Range	Default
	<n>	Discrete	{1 2 3 4}	---
	<bool>	Bool	{{1 ON} {0 OFF}}	0 OFF

**Remarks** When enabled, several data blocks will be combined based on the packet end.

**Return Format** The query returns 1 or 0.

**Example** :BUS1:RS232:PACKet ON /\*Enables the packet end during data transmission.\*/  
 :BUS1:RS232:PACKet? /\*The query returns 1.\*/

**:BUS<n>:RS232:PEND**

**Syntax** :BUS<n>:RS232:PEND <package end>

:BUS<n>:RS232:PEND?

**Description** Sets or queries the packet end type during data transmission.

Parameter	Name	Type	Range	Default
	<n>	Discrete	{1 2 3 4}	---
	<package end>	Discrete	{NULL LF CR SP}	NULL

**Remarks** The parameters are represented in hexadecimal as follows:

NULL: 00

LF: 0A

CR: 0D

SP: 20

**Return Format** The query returns NULL, LF, CR, or SP.

**Example** :BUS1:RS232:PEND LF /\*Sets the packet end to 0A.\*/  
:BUS1:RS232:PEND? /\*The query returns LF.\*/

## :BUS<n>:IIC (Option)

The :BUS<n>:IIC commands are used to set relevant parameters for I2C decoding.

### Command List:

- ◆ [:BUS<n>:IIC:SCLK:SOURce](#)
- ◆ [:BUS<n>:IIC:SDA:SOURce](#)
- ◆ [:BUS<n>:IIC:ADDRess](#)

### :BUS<n>:IIC:SCLK:SOURce

**Syntax** :BUS<n>:IIC:SCLK:SOURce <source>

:BUS<n>:IIC:SCLK:SOURce?

**Description** Sets or queries the clock source of I2C decoding.

Parameter	Name	Type	Range	Default
	<n>	Discrete	{1 2 3 4}	---
	<source>	Discrete	{D0 D1 D2 D3 D4 D5 D6 D7 D8 D9 D10 D11 D12 D13 D14 D15 CHANnel1 CHANnel2 CHANnel3 CHANnel4}	CHANnel1

**Return Format** The query returns D0, D1, D2, D3, D4, D5, D6, D7, D8, D9, D10, D11, D12, D13, D14, D15, CHAN1, CHAN2, CHAN3, or CHAN4.

**Example** :BUS1:IIC:SCLK:SOURce D0 /\*Sets the clock source of I2C decoding to D0.\*/  
:BUS1:IIC:SCLK:SOURce? /\*The query returns D0.\*/\*

### :BUS<n>:IIC:SDA:SOURce

**Syntax** :BUS<n>:IIC:SDA:SOURce <source>

:BUS<n>:IIC:SDA:SOURce?

**Description** Sets or queries the data channel source of I2C decoding.

Parameter	Name	Type	Range	Default
	<n>	Discrete	{1 2 3 4}	---
	<source>	Discrete	{D0 D1 D2 D3 D4 D5 D6 D7 D8 D9 D10 D11 D12 D13 D14 D15 CHANnel1 CHANnel2 CHANnel3 CHANnel4}	CHANnel1

**Return Format** The query returns D0, D1, D2, D3, D4, D5, D6, D7, D8, D9, D10, D11, D12, D13, D14, D15, CHAN1, CHAN2, CHAN3, or CHAN4.

**Example** :BUS1:IIC:SDA:SOURce D0 /\*Sets the data channel source of I2C decoding to D0.\*/  
:BUS1:IIC:SDA:SOURce? /\*The query returns D0.\*/\*

**:BUS<n>:IIC:ADDRess**

**Syntax** :BUS<n>:IIC:ADDRess <addr>

:BUS<n>:IIC:ADDRess?

**Description** Sets or queries the address mode of I2C decoding.

**Parameter**

Name	Type	Range	Default
<n>	Discrete	{1 2 3 4}	---
<addr>	Discrete	{NORMal RW}	NORMal

- Remarks**
- NORMal: indicates that the address width does not include the R/W bit.
  - RW: indicates that the address width includes the R/W bit.

**Return Format** The query returns NORM or RW.

**Example** :BUS1:IIC:ADDRess RW /\*Sets the address of I2C decoding to include the R/W bit.\*/  
:BUS1:IIC:ADDRess? /\*The query returns RW.\*/\*

## :BUS<n>:SPI (Option)

The :BUS<n>:SPI commands are used to set relevant parameters for SPI decoding.

### Command List:

- ◆ [:BUS<n>:SPI:SCLK:SOURce](#)
- ◆ [:BUS<n>:SPI:SCLK:SLOPe](#)
- ◆ [:BUS<n>:SPI:MISO:SOURce](#)
- ◆ [:BUS<n>:SPI:MISO:POLarity](#)
- ◆ [:BUS<n>:SPI:MOSI:SOURce](#)
- ◆ [:BUS<n>:SPI:MOSI:POLarity](#)
- ◆ [:BUS<n>:SPI:DBITs](#)
- ◆ [:BUS<n>:SPI:ENDian](#)
- ◆ [:BUS<n>:SPI:MODE](#)
- ◆ [:BUS<n>:SPI:TIMEout:TIME](#)
- ◆ [:BUS<n>:SPI:SS:SOURce](#)
- ◆ [:BUS<n>:SPI:SS:POLarity](#)

### :BUS<n>:SPI:SCLK:SOURce

**Syntax** :BUS<n>:SPI:SCLK:SOURce <source>  
:BUS<n>:SPI:SCLK:SOURce?

**Description** Sets or queries the clock source of SPI decoding.

Parameter	Name	Type	Range	Default
<n>		Discrete	{1 2 3 4}	---
<source>		Discrete	{D0 D1 D2 D3 D4 D5 D6 D7 D8 D9 D10 D11 D12 D13 D14 D15 CHANnel1 CHANnel2 CHANnel3 CHANnel4}	CHANnel1

**Return Format** The query returns D0, D1, D2, D3, D4, D5, D6, D7, D8, D9, D10, D11, D12, D13, D14, D15, CHAN1, CHAN2, CHAN3, or CHAN4.

**Example** :BUS1:SPI:SCLK:SOURce D0 /\*Sets the clock source of SPI decoding to D0.\*/  
:BUS1:SPI:SCLK:SOURce? /\*The query returns D0.\*/\*

**:BUS<n>:SPI:SCLK:SLOPe**

**Syntax** :BUS<n>:SPI:SCLK:SLOPe <slope>

:BUS<n>:SPI:SCLK:SLOPe?

**Description** Sets or queries the clock edge type of SPI decoding.

Parameter	Name	Type	Range	Default
	<n>	Discrete	{1 2 3 4}	---
	<slope>	Discrete	{POSitive NEGative}	POSitive

**Return Format** The query returns POS or NEG.

**Example** :BUS1:SPI:SCLK:SLOPe NEGative /\*Sets the clock edge type of SPI decoding to NEGative.\*/  
:BUS1:SPI:SCLK:SLOPe? /\*The query returns NEG.\*/

**:BUS<n>:SPI:MISO:SOURce**

**Syntax** :BUS<n>:SPI:MISO:SOURce <source>

:BUS<n>:SPI:MISO:SOURce?

**Description** Sets or queries the MISO data source of SPI decoding.

Parameter	Name	Type	Range	Default
	<n>	Discrete	{1 2 3 4}	---
	<source>	Discrete	{D0 D1 D2 D3 D4 D5 D6 D7 D8 D9 D10 D11 D12 D13 D14 D15 CHANnel1 CHANnel2 CHANnel3 CHANnel4 OFF}	OFF

**Return Format** The query returns D0, D1, D2, D3, D4, D5, D6, D7, D8, D9, D10, D11, D12, D13, D14, D15, CHAN1, CHAN2, CHAN3, CHAN4, or OFF.

**Example** :BUS1:SPI:MISO:SOURce D0 /\*Sets the MISO data source of SPI decoding to D0.\*/  
:BUS1:SPI:MISO:SOURce? /\*The query returns D0.\*/

**:BUS<n>:SPI:MISO:POLarity**

**Syntax** :BUS<n>:SPI:MISO:POLarity <polarity>

:BUS<n>:SPI:MISO:POLarity?

**Description** Sets or queries the polarity of MISO data line of SPI decoding.

Parameter	Name	Type	Range	Default
	<n>	Discrete	{1 2 3 4}	---
	<polarity>	Discrete	{HIGH LOW}	LOW

**Remarks** ➤ HIGH: indicates that low level is 1, and high level is 0.  
➤ LOW: indicates that high level is 1, and low level is 0.

**Return Format** The query returns HIGH or LOW.

**Example** :BUS1:SPI:MISO:POLarity HIGH /\*Sets the polarity of MISO data line to HIGH.\*/  
:BUS1:SPI:MISO:POLarity? /\*The query returns HIGH.\*/

**:BUS<n>:SPI:MOSI:SOURce**

**Syntax** :BUS<n>:SPI:MOSI:SOURce <source>

:BUS<n>:SPI:MOSI:SOURce?

**Description** Sets or queries the MOSI data source of SPI decoding.

Parameter	Name	Type	Range	Default
	<n>	Discrete	{1 2 3 4}	---
	<source>	Discrete	{D0 D1 D2 D3 D4 D5 D6 D7 D8 D9 D10 D11 D12 D13 D14 D15 CHANnel1 CHANnel2 CHANnel3 CHANnel4 OFF}	OFF

**Return Format** The query returns D0, D1, D2, D3, D4, D5, D6, D7, D8, D9, D10, D11, D12, D13, D14, D15, CHAN1, CHAN2, CHAN3, CHAN4, or OFF.

**Example** :BUS1:SPI:MOSI:SOURce D0 /\*Sets the MOSI data source of SPI decoding to D0.\*/  
:BUS1:SPI:MOSI:SOURce? /\*The query returns D0.\*/\*

**:BUS<n>:SPI:MOSI:POLarity**

**Syntax** :BUS<n>:SPI:MOSI:POLarity <polarity>

:BUS<n>:SPI:MOSI:POLarity?

**Description** Sets or queries the polarity of MOSI data line of SPI decoding.

Parameter	Name	Type	Range	Default
	<n>	Discrete	{1 2 3 4}	---
	<polarity>	Discrete	{HIGH LOW}	LOW

- Remarks**
- High: indicates that low level is 1, and high level is 0.
  - Low: indicates that high level is 1, and low level is 0.

**Return Format** The query returns HIGH or LOW.

**Example** :BUS1:SPI:MOSI:POLarity HIGH /\*Sets the polarity of MOSI data line to HIGH.\*/  
:BUS1:SPI:MOSI:POLarity? /\*The query returns HIGH.\*/\*

**:BUS<n>:SPI:DBITs**

**Syntax** :BUS<n>:SPI:DBITs <width>

:BUS<n>:SPI:DBITs?

**Description** Sets or queries the data width of SPI decoding.

Parameter	Name	Type	Range	Default
	<n>	Discrete	{1 2 3 4}	---
	<width>	Integer	4 to 32	8

**Return Format** The query returns an integer ranging from 4 to 32.

**Example** :BUS1:SPI:DBITs 10 /\*Sets the data width of SPI decoding to 10.\*/  
:BUS1:SPI:DBITs? /\*The query returns 10.\*/\*

**:BUS<n>:SPI:ENDian****Syntax** :BUS<n>:SPI:ENDian <endian>

:BUS&lt;n&gt;:SPI:ENDian?

**Description** Sets or queries the endian of data transmission in SPI decoding.

Parameter	Name	Type	Range	Default
	<n>	Discrete	{1 2 3 4}	---
	<endian>	Discrete	{MSB LSB}	MSB

- Remarks**
- MSB: indicates Most Significant Bit transmission sequence, i.g. the highest bit of the data is transmitted first.
  - LSB: indicates Least Significant Bit transmission sequence, i.g. the lowest bit of the data is transmitted first.

**Return Format** The query returns MSB or LSB.

**Example** :BUS1:SPI:ENDian LSB /\*Sets the endian of data transmission of SPI decoding to LSB.\*/

:BUS1:SPI:ENDian? /\*The query returns LSB.\*/

**:BUS<n>:SPI:MODE****Syntax** :BUS<n>:SPI:MODE <mode>

:BUS&lt;n&gt;:SPI:MODE?

**Description** Sets or queries the decode mode of SPI decoding.

Parameter	Name	Type	Range	Default
	<n>	Discrete	{1 2 3 4}	---
	<mode>	Discrete	{CS TIMEout}	TIMEout

- Remarks**
- CS: indicates chip select. CS: contains a chip select line (CS). You can perform frame synchronization according to CS.
  - TIMEout: indicates timed out. You can perform frame synchronization according to the timeout. At this time, you can send the [:BUS<n>:SPI:TIMEout:TIME](#) command to set the timeout value.

**Return Format** The query returns CS or TIM.

**Example** :BUS1:SPI:MODE CS /\*Sets the decode mode of SPI decoding to CS.\*/

:BUS1:SPI:MODE? /\*The query returns CS.\*/



**:BUS<n>:SPI:TIMEout:TIME**

**Syntax** :BUS<n>:SPI:TIMEout:TIME <time>

:BUS<n>:SPI:TIMEout:TIME?

**Description** Sets or queries the timeout value of SPI decoding. The default unit is s.

Parameter	Name	Type	Range	Default
	<n>	Discrete	{1 2 3 4}	---
	<time>	Real	8 ns to 10 s	1 $\mu$ s

- Remarks**
- The timeout must be greater than the maximum clock pulse width and less than the idle time between frames.
  - This setting command is only valid in timeout mode.

**Return Format** The query returns the timeout value in scientific notation.

**Example** :BUS1:SPI:TIMEout:TIME 0.000005 /\*Sets the timeout value to 5  $\mu$ s.\*/  
:BUS1:SPI:TIMEout:TIME? /\*The query returns 5.000000E-6.\*/\*

**:BUS<n>:SPI:SS:SOURce**

**Syntax** :BUS<n>:SPI:SS:SOURce <source>

:BUS<n>:SPI:SS:SOURce?

**Description** Sets or queries the source channel of the CS line of SPI decoding.

Parameter	Name	Type	Range	Default
	<n>	Discrete	{1 2 3 4}	---
	<source>	Real	{D0 D1 D2 D3 D4 D5 D6 D7 D8 D9 D10 D11 D12 D13 D14 D15 CHANnel1 CHANnel2 CHANnel3 CHANnel4}	CHANnel1

**Return Format** The query returns D0, D1, D2, D3, D4, D5, D6, D7, D8, D9, D10, D11, D12, D13, D14, D15, CHAN1, CHAN2, CHAN3, or CHAN4.

**Example** :BUS1:SPI:SS:SOURce D0 /\*Sets the source channel of CS line of SPI decoding to D0.\*/  
:BUS1:SPI:SS:SOURce? /\*The query returns D0.\*/\*

**:BUS<n>:SPI:SS:POLarity****Syntax** :BUS<n>:SPI:SS:POLarity <polarity>

:BUS&lt;n&gt;:SPI:SS:POLarity?

**Description** Sets or queries the polarity of the CS line of SPI decoding.**Parameter**

Name	Type	Range	Default
<n>	Discrete	{1 2 3 4}	---
<polarity>	Discrete	{HIGH LOW}	LOW

- Remarks**
- HIGH: indicates that the oscilloscope samples data of the source channel of data line on the specified edge of the clock signal when the CS signal is high level.
  - LOW: indicates that the oscilloscope samples data of the source channel of data line on the specified edge of the clock signal when the CS signal is low level.

**Return Format** The query returns HIGH or LOW.

**Example** :BUS1:SPI:SS:POLarity HIGH /\*Sets the polarity of CS line of SPI decoding to HIGH.\*/  
:BUS1:SPI:SS:POLarity? /\*The query returns HIGH.\*/

## :BUS<n>:CAN (Option)

The :BUS<n>:CAN commands are used to set relevant parameters for CAN decoding.

### Command List:

- ◆ [:BUS<n>:CAN:SOURce](#)
- ◆ [:BUS<n>:CAN:STYPe](#)
- ◆ [:BUS<n>:CAN:BAUD](#)
- ◆ [:BUS<n>:CAN:SPOint](#)

### :BUS<n>:CAN:SOURce

**Syntax** :BUS<n>:CAN:SOURce <source>  
:BUS<n>:CAN:SOURce?

**Description** Sets or queries the source channel of CAN decoding.

Parameter	Name	Type	Range	Default
	<n>	Discrete	{1 2 3 4}	---
	<source>	Discrete	{D0 D1 D2 D3 D4 D5 D6 D7 D8 D9 D10 D11 D12 D13 D14 D15 CHANnel1 CHANnel2 CHANnel3 CHANnel4}	CHANnel1

**Return Format** The query returns D0, D1, D2, D3, D4, D5, D6, D7, D8, D9, D10, D11, D12, D13, D14, D15, CHAN1, CHAN2, CHAN3, or CHAN4.

**Example** :BUS1:CAN:SOURce D0 /\*Sets the source channel of CAN decoding to D0.\*/  
:BUS1:CAN:SOURce? /\*The query returns D0.\*/\*

### :BUS<n>:CAN:STYPe

**Syntax** :BUS<n>:CAN:STYPe <stype>  
:BUS<n>:CAN:STYPe?

**Description** Sets or queries the signal type of CAN decoding.

Parameter	Name	Type	Range	Default
	<n>	Discrete	{1 2 3 4}	---
	<stype>	Discrete	{TX RX CANH CANL DIFFerential}	RX

- Remarks**
- TX: indicates the Transmit signal from the CAN bus transceiver.
  - RX: indicates the Receive signal from the CAN bus transceiver.
  - CANH: indicates the actual CAN\_H bus signal.
  - CANL: indicates the actual CAN\_L bus signal.
  - DIFFerential: indicates the CAN differential bus signal connected to an analog channel by using a differential probe. Connect the differential probe's positive lead to the CAN\_H bus signal and connect the negative lead to the CAN\_L bus signal.

**Return Format** The query returns TX, RX, CANH, CANL, or DIFF.

**Example** :BUS1:CAN:STYPe TX /\*Sets the signal type of CAN decoding to TX.\*/  
:BUS1:CAN:STYPe? /\*The query returns TX.\*/\*

**:BUS<n>:CAN:BAUD**

**Syntax** :BUS<n>:CAN:BAUD <baud>

:BUS<n>:CAN:BAUD?

**Description** Sets or queries the signal rate of CAN decoding. The default unit is bps.

Parameter	Name	Type	Range	Default
	<n>	Discrete	{1 2 3 4}	---
	<baud>	Integer	10 kbps to 5 Mbps	1 Mbps

**Remarks** If the baud rate is set to a value with "M", then "A" should be added at the end of the value. For example, if you send 5 M, you need to send 5 MA.

**Return Format** The query returns an integer ranging from 10 kbps to 5 Mbps.

**Example** :BUS1:CAN:BAUD 120000 /\*Sets the signal rate of CAN decoding to 120000 bps.\*/  
:BUS1:CAN:BAUD? /\*The query returns 120000.\*/

**:BUS<n>:CAN:SPOint**

**Syntax** :BUS<n>:CAN:SPOint <spoint>

:BUS<n>:CAN:SPOint?

**Description** Sets or queries the sample point position of CAN decoding (expressed in %).

Parameter	Name	Type	Range	Default
	<n>	Discrete	{1 2 3 4}	---
	<spoint>	Integer	10 to 90	50

**Remarks** Sample point is a point within a bit's time. The oscilloscope samples the bit level at this point. The sample point position is expressed as the ratio of "time from the bit start to the sample point" to "bit time", in %.

**Return Format** The query returns an integer ranging from 10 to 90.

**Example** :BUS1:CAN:SPOint 70 /\*Sets the sample point position of CAN decoding to 70%.\*/  
:BUS1:CAN:SPOint? /\*The query returns 70.\*/

## :BUS<n>:FLEXray (Option)

The :BUS<n>:FLEXray commands are used to set the relevant parameters for FLEXray decoding.

### Command List:

- ◆ [:BUS<n>:FLEXray:BAUD](#)
- ◆ [:BUS<n>:FLEXray:SOURce](#)
- ◆ [:BUS<n>:FLEXray:SPOint](#)
- ◆ [:BUS<n>:FLEXray:STYPe](#)

### :BUS<n>:FLEXray:BAUD

**Syntax** :BUS<n>:FLEXray:BAUD <baud>  
:BUS<n>:FLEXray:BAUD?

**Description** Sets or queries the signal rate of FlexRay decoding. The default unit is bps.

Parameter	Name	Type	Range	Default
	<n>	Discrete	{1 2 3 4}	---
	<baud>	Discrete	{2500000 5000000 10000000}	10000000

**Return Format** The query returns 2500000, 5000000, or 10000000.

**Example** :BUS1:FLEXray:BAUD 2500000 /\*Sets the signal rate of FlexRay decoding to 2500000 bps.\*/  
:BUS1:FLEXray:BAUD? /\*The query returns 2500000.\*/\*

### :BUS<n>:FLEXray:SOURce

**Syntax** :BUS<n>:FLEXray:SOURce <source>  
:BUS<n>:FLEXray:SOURce?

**Description** Sets or queries the source channel of FlexRay decoding.

Parameter	Name	Type	Range	Default
	<n>	Discrete	{1 2 3 4}	---
	<source>	Discrete	{D0 D1 D2 D3 D4 D5 D6 D7 D8 D9 D10 D11 D12 D13 D14 D15 CHANnel1 CHANnel2 CHANnel3 CHANnel4}	CHANnel1

**Return Format** The query returns D0, D1, D2, D3, D4, D5, D6, D7, D8, D9, D10, D11, D12, D13, D14, D15, CHAN1, CHAN2, CHAN3, or CHAN4.

**Example** :BUS1:FlexRay:SOURce D0 /\*Sets the source channel of FlexRay decoding to D0.\*/  
:BUS1:FlexRay:SOURce? /\*The query returns D0.\*/\*

**:BUS<n>:FLEXray:SPOint****Syntax** :BUS<n>:FLEXray:SPOint <spoint>

:BUS&lt;n&gt;:FLEXray:SPOint?

**Description** Sets or queries the sample point position of FlexRay decoding (expressed in %).

Parameter	Name	Type	Range	Default
	<n>	Discrete	{1 2 3 4}	---
	<spoint>	Integer	10 to 90	50

**Remarks** Sample point is a point within a bit's time. The oscilloscope samples the bit level at this point. The sample point position is expressed as the ratio of "time from the bit start to the sample point" to "bit time", in %.**Return Format** The query returns an integer ranging from 10 to 90.

**Example** :BUS1:FLEXray:SPOint 70 /\*Sets the sample point position of FlexRay decoding to 70%.\*/

:BUS1:FLEXray:SPOint? /\*The query returns 70.\*/

**:BUS<n>:FLEXray:STYPe****Syntax** :BUS<n>:FLEXray:STYPe <stype>

:BUS&lt;n&gt;:FLEXray:STYPe?

**Description** Sets or queries the signal type of FlexRay decoding.

Parameter	Name	Type	Range	Default
	<n>	Discrete	{1 2 3 4}	---
	<stype>	Discrete	{BP BM RT}	BP

**Return Format** The query returns BP, BM, or RT.

**Example** :BUS1:FLEXray:STYPe BM /\*Sets the signal type of FlexRay decoding to BM.\*/

:BUS1:FLEXray:STYPe? /\*The query returns BM.\*/

## :BUS<n>:LIN (Option)

The :BUS<n>:LIN commands are used to set relevant parameters for LIN decoding.

### Command List:

- ◆ [:BUS<n>:LIN:BAUD](#)
- ◆ [:BUS<n>:LIN:POLarity](#)
- ◆ [:BUS<n>:LIN:SOURce](#)
- ◆ [:BUS<n>:LIN:STANdard](#)

### :BUS<n>:LIN:BAUD

**Syntax** :BUS<n>:LIN:BAUD <baud>  
:BUS<n>:LIN:BAUD?

**Description** Sets or queries the baud rate of LIN decoding. The default unit is bps.

Parameter	Name	Type	Range	Default
	<n>	Discrete	{1 2 3 4}	---
	<baud>	Integer	2.4 kbps to 20 Mbps	19200 bps

**Remarks** If the baud rate is set to a value with "M", then "A" should be added at the end of the value. For example, if you send 5 M, you need to send 5 MA.

**Return Format** The query returns an integer ranging from 2.4 kbps to 20 Mbps.

**Example** :BUS1:LIN:BAUD 9600 /\*Sets the baud rate of LIN decoding to 9600 bps.\*/  
:BUS1:LIN:BAUD? /\*The query returns 9600.\*/

### :BUS<n>:LIN:POLarity

**Syntax** :BUS<n>:LIN:POLarity <bool>  
:BUS<n>:LIN:POLarity?

**Description** Sets or queries the parity bit of LIN decoding.

Parameter	Name	Type	Range	Default
	<n>	Discrete	{1 2 3 4}	---
	<bool>	Bool	{{1 ON} {0 OFF}}	0 OFF

**Return Format** The query returns 0 or 1.

**Example** :BUS1:LIN:POLarity ON /\*Sets the parity bit to be included in LIN decoding.\*/  
:BUS1:LIN:POLarity? /\*The query returns 1.\*/

**:BUS<n>:LIN:SOURce**

**Syntax** :BUS<n>:LIN:SOURce <source>

:BUS<n>:LIN:SOURce?

**Description** Sets or queries the source of LIN bus.

Parameter	Name	Type	Range	Default
	<n>	Discrete	{1 2 3 4}	---
	<source>	Discrete	{D0 D1 D2 D3 D4 D5 D6 D7 D8 D9 D10 D11 D12 D13 D14 D15 CHANnel1 CHANnel2 CHANnel3 CHANnel4}	CHANnel1

**Return Format** The query returns D0, D1, D2, D3, D4, D5, D6, D7, D8, D9, D10, D11, D12, D13, D14, D15, CHAN1, CHAN2, CHAN3, or CHAN4.

**Example** :BUS1:LIN:SOURce D0 /\*Sets the source of LIN bus to D0.\*/  
:BUS1:LIN:SOURce? /\*The query returns D0.\*/\*

**:BUS<n>:LIN:STANdard**

**Syntax** :BUS<n>:LIN:STANdard <value>

:BUS<n>:LIN:STANdard?

**Description** Sets or queries the version of LIN bus.

Parameter	Name	Type	Range	Default
	<n>	Discrete	{1 2 3 4}	---
	<value>	Discrete	{V1X V2X MIXed}	V1X

**Return Format** The query returns V1X, V2X, or MIX.

**Example** :BUS1:LIN:STANdard V2X /\*Sets the version of LIN bus to V2X.\*/  
:BUS1:LIN:STANdard? /\*The query returns V2X.\*/\*



## :BUS<n>:IIS (Option)

The :BUS<n>:IIS commands are used to set relevant parameters for I2S decoding.

### Command List:

- ◆ [:BUS<n>:IIS:SOURce:CLOCK](#)
- ◆ [:BUS<n>:IIS:SOURce:DATA](#)
- ◆ [:BUS<n>:IIS:SOURce:WSElect](#)
- ◆ [:BUS<n>:IIS:ALIGnment](#)
- ◆ [:BUS<n>:IIS:CLOCK:SLOPe](#)
- ◆ [:BUS<n>:IIS:RWIDth](#)

### :BUS<n>:IIS:SOURce:CLOCK

**Syntax** :BUS<n>:IIS:SOURce:CLOCK <source>

:BUS<n>:IIS:SOURce:CLOCK?

**Description** Sets or queries the clock source of the I2S decoding.

Parameter	Name	Type	Range	Default
	<n>	Discrete	{1 2 3 4}	---
	<source>	Discrete	{D0 D1 D2 D3 D4 D5 D6 D7 D8 D9 D10 D11 D12 D13 D14 D15 CHANnel1 CHANnel2 CHANnel3 CHANnel4}	CHANnel1

**Return Format** The query returns D0, D1, D2, D3, D4, D5, D6, D7, D8, D9, D10, D11, D12, D13, D14, D15, CHAN1, CHAN2, CHAN3, or CHAN4.

**Example** :BUS1:IIS:SOURce:CLOCK D0 /\*Sets the clock source of the I2S decoding to D0.\*/  
:BUS1:IIS:SOURce:CLOCK? /\*The query returns D0.\*/\*

### :BUS<n>:IIS:SOURce:DATA

**Syntax** :BUS<n>:IIS:SOURce:DATA<source>

:BUS<n>:IIS:SOURce:DATA?

**Description** Sets or queries the data source of the I2S decoding.

Parameter	Name	Type	Range	Default
	<n>	Discrete	{1 2 3 4}	---
	<source>	Discrete	{D0 D1 D2 D3 D4 D5 D6 D7 D8 D9 D10 D11 D12 D13 D14 D15 CHANnel1 CHANnel2 CHANnel3 CHANnel4}	CHANnel1

**Return Format** The query returns D0, D1, D2, D3, D4, D5, D6, D7, D8, D9, D10, D11, D12, D13, D14, D15, CHAN1, CHAN2, CHAN3, or CHAN4.

**Example** :BUS1:IIS:SOURce:DATA D0 /\*Sets the data source of the I2S decoding to D0.\*/  
:BUS1:IIS:SOURce:DATA? /\*The query returns D0.\*/\*

**:BUS<n>:IIS:SOURce:WSElect**

**Syntax** :BUS<n>:IIS:SOURce:WSElect <source>

:BUS<n>:IIS:SOURce:WSElect?

**Description** Sets or queries the audio channel of the I2S trigger.

Parameter	Name	Type	Range	Default
	<n>	Discrete	{1 2 3 4}	---
	<source>	Discrete	{D0 D1 D2 D3 D4 D5 D6 D7 D8 D9 D10 D11 D12 D13 D14 D15 CHANnel1 CHANnel2 CHANnel3 CHANnel4}	CHANnel1

**Return Format** The query returns D0, D1, D2, D3, D4, D5, D6, D7, D8, D9, D10, D11, D12, D13, D14, D15, CHAN1, CHAN2, CHAN3, or CHAN4.

**Example** :BUS1:IIS:SOURce:WSElect CHANnel2 /\*Sets the audio channel to CHANnel2.\*/  
:BUS1:IIS:SOURce:WSElect? /\*The query returns CHAN2.\*/\*

**:BUS<n>:IIS:ALIGNment**

**Syntax** :BUS<n>:IIS:ALIGNment <align>

:BUS<n>:IIS:ALIGNment?

**Description** Sets or queries the alignment mode of the I2S decoding.

Parameter	Name	Type	Range	Default
	<n>	Discrete	{1 2 3 4}	---
	<align>	Discrete	{IIS RJ LJ}	IIS

- Remarks**
- IIS: first sends MSB of each sample data and then sends LSB.
  - RJ: data transmission (MSB first) is right-justified to the WS transition.
  - LJ: data transmission (MSB first) begins at the edge of the WS transition.

**Return Format** The query returns IIS, RJ, or LJ.

**Example** :BUS1:IIS:ALIGNment RJ /\*Sets the alignment mode of the I2S decoding to RJ.\*/  
:BUS1:IIS:ALIGNment? /\*The query returns RJ.\*/\*

**:BUS<n>:IIS:CLOCK:SLOPe**

**Syntax** :BUS<n>:IIS:CLOCK:SLOPe <slope>

:BUS<n>:IIS:CLOCK:SLOPe?

**Description** Sets or queries the clock edge type of I2S decoding.

Parameter	Name	Type	Range	Default
	<n>	Discrete	{1 2 3 4}	---
	<slope>	Discrete	{NEGative POSitive}	POSitive

**Return Format** The query returns POS or NEG.

**Example** :BUS1:IIS:CLOCK:SLOPe NEGative /\*Sets the clock edge of I2S decoding to NEGative.\*/  
:BUS1:IIS:CLOCK:SLOPe? /\*The query returns NEG.\*/\*

**:BUS<n>:IIS:RWIDth****Syntax** :BUS<n>:IIS:RWIDth <val>

:BUS&lt;n&gt;:IIS:RWIDth?

**Description** Sets or queries the word size of the I2S decoding.**Parameter**

Name	Type	Range	Default
<n>	Discrete	{1 2 3 4}	---
<val>	Integer	4 to 32	8

**Return Format**

The query returns an integer ranging from 4 to 32.

**Example**

:BUS1:IIS:RWIDth 5

/\*Sets the word size of I2S decoding to 5.\*/

:BUS1:IIS:RWIDth?

/\*The query returns 5.\*/

## :BUS<n>:M1553 (Option)

The :BUS<n>:M1553 commands are used to set relevant parameters for the M1553 decoding.

### Command List:

◆ [:BUS<n>:M1553:SOURce](#)

### :BUS<n>:M1553:SOURce

**Syntax** :BUS<n>:M1553:SOURce <source>

:BUS<n>:M1553:SOURce?

**Description** Sets or queries the source of the M1553 decoding.

Parameter	Name	Type	Range	Default
	<n>	Discrete	{1 2 3 4}	---
	<source>	Discrete	{CHANnel1 CHANnel2 CHANnel3 CHANnel4}	CHANnel1

**Return Format** The query returns CHAN1, CHAN2, CHAN3, or CHAN4.

**Example** :BUS1:M1553:SOURce CHANnel2

/\*Sets the source of the M1553 decoding to CHANnel2.\*/

:BUS1:M1553:SOURce?

/\*The query returns CHAN2.\*/

## :CHANnel<n> Commands

The :CHANnel<n> commands are used to set or query the bandwidth limit, coupling, vertical scale, vertical offset, and other vertical system parameters of the analog channel.

### Command List:

- ◆ [:CHANnel<n>:BWLimit](#)
- ◆ [:CHANnel<n>:COUPling](#)
- ◆ [:CHANnel<n>:DISPlay](#)
- ◆ [:CHANnel<n>:INVert](#)
- ◆ [:CHANnel<n>:OFFSet](#)
- ◆ [:CHANnel<n>:TCALibrate](#)
- ◆ [:CHANnel<n>:SCALe](#)
- ◆ [:CHANnel<n>:IMPedance](#)
- ◆ [:CHANnel<n>:CStArt](#)
- ◆ [:CHANnel<n>:PROBe](#)
- ◆ [:CHANnel<n>:PROBe:DELay](#)
- ◆ [:CHANnel<n>:PROBe:BIAS](#)
- ◆ [:CHANnel<n>:UNITs](#)
- ◆ [:CHANnel<n>:VERNier](#)

### :CHANnel<n>:BWLimit

**Syntax** :CHANnel<n>:BWLimit <type>

:CHANnel<n>:BWLimit?

**Description** Sets or queries the bandwidth limit of the specified channel.

Parameter	Name	Type	Range	Default
	<n>	Discrete	{1 2 3 4}	1
	<type>	Discrete	Refer to <b>Remarks</b>	OFF

- Remarks**
- The range of <type> is related to the instrument model.  
MSO8064: {20M|OFF}
  - MSO8104: {20M|250M|OFF}
  - 20M, 250M: When you enable the bandwidth limit and limit it to 20 MHz or 250 MHz, the high frequency components found in the signal under test that are greater than 20 MHz or 250 MHz are attenuated.
  - OFF: disables the bandwidth limit function. The high-frequency components in the signal under test can pass through the channel.

**Return Format** The query returns 20M, 250M, or OFF.

**Example** :CHANnel1:BWLimit 20M /\*Enables the 20 MHz bandwidth limit.\*/  
:CHANnel1:BWLimit? /\*The query returns 20M.\*/\*

**:CHANnel<n>:COUPling****Syntax** :CHANnel<n>:COUPling <coupling>

:CHANnel&lt;n&gt;:COUPling?

**Description** Sets or queries the coupling mode of the specified channel.

Parameter	Name	Type	Range	Default
	<n>	Discrete	{1 2 3 4}	1
	<coupling>	Discrete	{AC DC GND}	DC

- Remarks**
- AC: the DC components of the signal under test are blocked.
  - DC: both DC and AC components of the signal under test can pass through the channel.
  - GND: the DC and AC components of the signal under test are both blocked.

**Return Format** The query returns AC, DC, or GND.

**Example** :CHANnel1:COUPling AC /\*Selects the AC coupling mode.\*/  
 :CHANnel1:COUPling? /\*The query returns AC.\*/

**:CHANnel<n>:DISPlay****Syntax** :CHANnel<n>:DISPlay <bool>

:CHANnel&lt;n&gt;:DISPlay?

**Description** Turns on or off the specified channel; or queries the on/off status of the specified channel.

Parameter	Name	Type	Range	Default
	<n>	Discrete	{1 2 3 4}	1
	<bool>	Bool	{{1 ON} {0 OFF}}	0 OFF

**Return Format** The query returns 1 or 0.

**Example** :CHANnel1:DISPlay ON /\*Enables CH1.\*/  
 :CHANnel1:DISPlay? /\*The query returns 1.\*/

**:CHANnel<n>:INVert****Syntax** :CHANnel<n>:INVert <bool>

:CHANnel&lt;n&gt;:INVert?

**Description** Turns on or off the waveform invert for the specified channel; or queries the on/off status of the waveform invert for the specified channel.

Parameter	Name	Type	Range	Default
	<n>	Discrete	{1 2 3 4}	1
	<bool>	Bool	{{1 ON} {0 OFF}}	0 OFF

**Remarks** When the waveform invert is turned off, the waveform is displayed normally; when the waveform invert is turned on, the voltage values of the displayed waveform are inverted.

**Return Format** The query returns 1 or 0.

**Example** :CHANnel1:INVert ON /\*Enables the waveform invert for CH1.\*/  
:CHANnel1:INVert? /\*The query returns 1.\*/\*

## :CHANnel<n>:OFFSet

**Syntax** :CHANnel<n>:OFFSet <offset>  
:CHANnel<n>:OFFSet?

**Description** Sets or queries the vertical offset of the specified channel. The default unit is V.

Parameter	Name	Type	Range	Default
	<n>	Discrete	{1 2 3 4}	1
	<offset>	Real	Related to vertical scale and input impedance when the input impedance is 1 M $\Omega$ : $\pm 1$ V (1 mV/div to 50 mV/div). $\pm 30$ V (51 mV/div to 260 mV/div) $\pm 100$ V (265 mV/div to 10 V/div)  When the input impedance is 50 $\Omega$ : $\pm 1$ V (1 mV/div to 100 mV/div) $\pm 4$ V (102 mV/div to 1 V/div)	0 V

**Return Format** The query returns the vertical offset in scientific notation.

**Example** :CHANnel1:OFFSet 0.01 /\*Sets the vertical offset of CH1 to 10 mV.\*/  
:CHANnel1:OFFSet? /\*The query returns 1E-2.\*/\*

## :CHANnel<n>:TCALibrate

**Syntax** :CHANnel<n>:TCALibrate <val>  
:CHANnel<n>:TCALibrate?

**Description** Sets or queries the delay calibration time (used to calibrate the zero offset of the corresponding channel) of the specified channel. The default unit is s.

Parameter	Name	Type	Range	Default
	<n>	Discrete	{1 2 3 4}	1
	<val>	Real	-100 ns to 100 ns	0 s

- Remarks**
- Set the parameter <val> to a specific value at a specified step. If the parameter value is not within the settable range, select the value that is closest to the range automatically. In different horizontal time bases, the step values for the parameter are different.
  - When the horizontal time base is greater than 10  $\mu$ s, the parameter <val> cannot be set.

**Return Format** The query returns the delay calibration time in scientific notation.

**Example** :CHANnel1:TCALibrate 0.0000002 /\*Sets the delay calibration time to 20 ns.\*/  
:CHANnel1:TCALibrate? /\*The query returns 2.000000E-8.\*/\*

**:CHANnel<n>:SCALE**

**Syntax** :CHANnel<n>:SCALE <scale>

:CHANnel<n>:SCALE?

**Description** Sets or queries the vertical scale of the specified channel. The default unit is V.

Parameter	Name	Type	Range	Default
	<n>	Discrete	{1 2 3 4}	1
	<scale>	Real	Related to input impedance and probe ratio: when the input impedance is 1 M $\Omega$ , the probe ratio is 1X: 1 mV to 10 V when the input impedance is 50 $\Omega$ , the probe ratio is 1X: 1 mV to 1 V	100 mV

**Remarks** You can use the [:CHANnel<n>:VERNier](#) command to enable or disable the fine adjustment setting for the vertical scale of the specified channel. By default, the fine adjustment is Off. At this time, you can set the vertical scale at 1-2-5 step, i.g. 10 mV, 20 mV, 50 mV,...100 V. When the fine adjustment is enabled, you can further adjust the vertical scale within a relatively smaller range to improve vertical resolution. If the amplitude of the input waveform is a little bit greater than the full scale under the current scale and the amplitude would be a little bit lower if the next scale is used, fine adjustment can be used to improve the amplitude of waveform display to view signal details.

**Return Format** The query returns the vertical scale in scientific notation.

**Example** :CHANnel1:SCALE 1 /\*Sets the vertical scale of CH1 to 1 V.\*/  
:CHANnel1:SCALE? /\*The query returns 1.\*/

**:CHANnel<n>:IMPedance**

**Syntax** :CHANnel<n>:IMPedance <impedance>

:CHANnel<n>:IMPedance?

**Description** Sets or queries the input impedance of the specified analog channel. The default unit is  $\Omega$ .

Parameter	Name	Type	Range	Default
	<n>	Discrete	{1 2 3 4}	1
	<impedance>	Discrete	{OMEG FIFTy}	OMEG

**Remarks**

- OMEG: 1 M $\Omega$ . This indicates that the input impedance of the oscilloscope is rather high, and the current flowing from the circuit under test to the oscilloscope can be ignored.
- FIFTy: 50  $\Omega$ . This indicates that the oscilloscope shall be matched with a device whose output impedance is 50  $\Omega$ .

**Return Format** The query returns OMEG or FIFT.

**Example** :CHANnel1:IMPedance FIFTy /\*Sets the input impedance of CH1 to FIFTy.\*/  
:CHANnel1:IMPedance? /\*The query returns FIFT.\*/



**:CHANnel<n>:CStArt****Syntax** :CHANnel<n>:CStArt**Description** Starts calibration for the active probe currently connected to the specified analog channel.

Parameter	Name	Type	Range	Default
	<n>	Discrete	{1 2 3 4}	1

**Remarks** This command is only valid when an active probe is correctly connected.**:CHANnel<n>:PROBe****Syntax** :CHANnel<n>:PROBe <atten>

:CHANnel&lt;n&gt;:PROBe?

**Description** Sets or queries the probe ratio of the specified channel.

Parameter	Name	Type	Range	Default
	<n>	Discrete	{1 2 3 4}	1
	<atten>	Discrete	{0.01 0.02 0.05 0.1 0.2 0.5 1 2 5 10 20 50 100 200 500 1000 2000 5000 10000 20000 50000}	1

**Remarks** ➤ Sets the probe ratio. That is, multiply the acquired signal by a specified number (not affect the actual amplitude of the signal).

➤ The set probe ratio affects the settable range of the current vertical scale.

**Return Format** The query returns 0.01, 0.02, 0.05, 0.1, 0.2, 0.5, 1, 2, 5, 10, 20, 50, 100, 200, 500, 1000, 2000, 5000, 10000, 20000, or 50000.**Example** :CHANnel1:PROBe 10 /\*Sets the probe ratio of CH1 to 10X.\*/  
:CHANnel1:PROBe? /\*The query returns 10.\*/**:CHANnel<n>:PROBe:DELAy****Syntax** :CHANnel<n>:PROBe:DELAy <delay>

:CHANnel&lt;n&gt;:PROBe:DELAy?

**Description** Sets or queries the probe delay time of the specified channel.

Parameter	Name	Type	Range	Default
	<n>	Discrete	{1 2 3 4}	1
	<delay>	Real	-100 ns to 100 ns	0 s

**Remarks** ➤ To avoid measurement result errors arising from the transmission delay of the probe cable, the oscilloscope provides the probe delay adjustment function for the active probe.

➤ This command is only valid when an active probe is correctly connected.

**Return Format** The query returns the probe delay time in scientific notation.**Format**

**:CHANnel<n>:PROBe:BIAS**

**Syntax** :CHANnel<n>:PROBe:BIAS <bias>

:CHANnel<n>:PROBe:BIAS?

**Description** Sets or queries the probe bias voltage of the specified channel.

Parameter	Name	Type	Range	Default
	<n>	Discrete	{1 2 3 4}	1
	<bias>	Real	-5 V to 5 V	0 V

- Remarks**
- This function is used to adjust the signal under test that exceeds the input dynamic range of the probe amplifier to an appropriate range to ensure the signal integrity.
  - This command is only valid when an active probe is correctly connected.

**Return** The query returns the probe bias voltage in scientific notation.

**Format**

**:CHANnel<n>:UNITs**

**Syntax** :CHANnel<n>:UNITs <units>

:CHANnel<n>:UNITs?

**Description** Sets or queries the amplitude display unit of the specified analog channel.

Parameter	Name	Type	Range	Default
	<n>	Discrete	{1 2 3 4}	1
	<units>	Discrete	{VOLTage WATT AMPere UNKNown}	VOLTage

**Return** The query returns VOLT, WATT, AMP, or UNKN.

**Format**

**Example** :CHANnel1:UNITs VOLTage /\*Sets the amplitude display unit of CH1 to VOLTage.\*  
:CHANnel1:UNITs? /\*The query returns VOLT.\*

**:CHANnel<n>:VERNier**

**Syntax** :CHANnel<n>:VERNier <bool>

:CHANnel<n>:VERNier?

**Description** Enables or disables the fine adjustment of the vertical scale of the specified analog channel; or queries the on/off status of the fine adjustment function of the vertical scale of the specified analog channel.

Parameter	Name	Type	Range	Default
	<n>	Discrete	{1 2 3 4}	1
	<bool>	Bool	{{1 ON} {0 OFF}}	0 OFF

**Remarks** By default, the fine adjustment is Off. At this time, you can set the vertical scale at 1-2-5 step, i.g. 10 mV, 20 mV, 50 mV, 100 mV...100 V. When the fine adjustment is enabled, you can further adjust the vertical scale within a relatively smaller range to improve vertical resolution. If the amplitude of the input waveform is a little bit greater than the full scale under the current scale and the amplitude would be a little bit lower if the next scale is used, fine adjustment can be used to improve the amplitude of waveform display to view

signal details.

**Return  
Format** The query returns 1 or 0.

**Example** :CHANnel1:VERNier ON /\*Enables the fine adjustment of the vertical scale of CH1.\*/  
:CHANnel1:VERNier? /\*The query returns 1.\*/\*

## :CLOCK Commands

### Command List:

- ◆ [:CLOCK:METHod](#)
- ◆ [:CLOCK:TYPE](#)
- ◆ [:CLOCK:RATE](#)
- ◆ [:CLOCK:PLL:ORDer](#)
- ◆ [:CLOCK:PLL:BW](#)
- ◆ [:CLOCK:EXTChan](#)

### :CLOCK:METHod

**Syntax** :CLOCK:METHod <type>

:CLOCK:METHod?

**Description** Sets or queries the clock recovery method.

Parameter	Name	Type	Range	Default
	<type>	Discrete	{CONSTant PLL EXPLicit}	CONSTant

**Remarks** The clock recovery provides an ideal clock for comparison to actual signal edges.

**Return** The query returns CONS, PLL, or EXPL.

**Format**

**Example** :CLOCK:METHod PLL /\*Sets the clock recovery method to PLL.\*/  
:CLOCK:METHod? /\*The query returns PLL.\*/

### :CLOCK:TYPE

**Syntax** :CLOCK:TYPE <type>

:CLOCK:TYPE?

**Description** Sets or queries the data rate type of the constant clock recovery method.

Parameter	Name	Type	Range	Default
	<type>	Discrete	{AUT SEM MAN}	AUT

**Return** The query returns AUT, SEM, or MAN.

**Format**

**Example** :CLOCK:TYPE AUT  
/\*Sets the data rate type of the constant clock recovery method to AUT.\*/  
:CLOCK:TYPE?  
/\*The query returns AUT.\*/

**:CLOCK:RATE****Syntax** :CLOCK:RATE <val>

:CLOCK:RATE?

**Description** Sets or queries the data rate of the Manual method.**Parameter**

Name	Type	Range	Default
<val>	Integer	1 Mb/s to 4 Gb/s	500 Mb/s

**Return Format**

The query returns the data rate of the Manual method in integer.

**Example**

```
:CLOCK:RATE 10000000      /*Sets the data rate of the Manual method to 10 Mb/s.*/
:CLOCK:RATE?              /*The query returns 10000000.*/
```

**:CLOCK:PLL:ORDER****Syntax** :CLOCK:PLL:ORDER <ord>

:CLOCK:PLL:ORDER?

**Description** Sets or queries the PLL order.**Parameter**

Name	Type	Range	Default
<ord>	Discrete	{ONE TWO}	ONE

**Return Format**

The query returns ONE or TWO.

**Example**

```
:CLOCK:PLL:ORDER TWO      /*Sets the PLL order to TWO.*/
:CLOCK:PLL:ORDER?        /*The query returns TWO.*/
```

**:CLOCK:PLL:BW****Syntax** :CLOCK:PLL:BW <val>

:CLOCK:PLL:BW?

**Description** Sets or queries the PLL loop bandwidth.**Parameter**

Name	Type	Range	Default
<val>	Integer	1 kHz to 1 MHz	300 kHz

**Return Format**

The query returns the PLL loop bandwidth in integer.

**Example**

```
:CLOCK:PLL:BW 100000      /*Sets the PLL loop bandwidth to 100 kHz.*/
:CLOCK:PLL:BW?           /*The query returns 100000.*/
```

**:CLOCK:EXTChan**

**Syntax** :CLOCK:EXTChan <ch>

:CLOCK:EXTChan?

**Description** Sets or queries the source of the external clock recovery method.

Parameter	Name	Type	Range	Default
	<ch>	Discrete	{CHANnel1 CHANnel2 CHANnel3 CHANnel4}	CHANnel2

**Return Format** The query returns CHAN1, CHAN2, CHAN3, or CHAN4.

**Example** :CLOCK:EXTChan CHANnel3

/\*Sets the source of the external clock recovery method to CH3.\*/

:CLOCK:EXTChan?

/\*The query returns CHAN3.\*/

## :COUNTER Commands

### Command List:

- ◆ [:COUNTER:CURRENT?](#)
- ◆ [:COUNTER:ENABLE](#)
- ◆ [:COUNTER:SOURCce](#)
- ◆ [:COUNTER:MODE](#)
- ◆ [:COUNTER:NDIGits](#)
- ◆ [:COUNTER:TOTALize:ENABLE](#)
- ◆ [:COUNTER:TOTALize:CLEAr](#)

### :COUNTER:CURRENT?

**Syntax** :COUNTER:CURRENT?

**Description** Queries the measurement value of the frequency counter.

**Return** The query returns 1.000006E+3.

**Format**

### :COUNTER:ENABLE

**Syntax** :COUNTER:ENABLE <bool>

:COUNTER:ENABLE?

**Description** Enables or disables the frequency counter; or queries the on/off status of the frequency counter.

**Parameter**

Name	Type	Range	Default
<bool>	Bool	{{1 ON}} {{0 OFF}}	0 OFF

**Return** The query returns 1 or 0.

**Format**

**Example** :COUNTER:ENABLE ON /\*Enables the frequency counter.\*/  
:COUNTER:ENABLE? /\*The query returns 1.\*/\*

### :COUNTER:SOURCce

**Syntax** :COUNTER:SOURCce <source>

:COUNTER:SOURCce?

**Description** Sets or queries the source of the frequency counter.

**Parameter**

Name	Type	Range	Default
<source>	Discrete	{D0 D1 D2 D3 D4 D5 D6 D7 D8 D9 D10 D11 D12 D13 D14 D15 CHANnel1 CHANnel2 CHANnel3 CHANnel4 EXT}	CHANnel1

**Return** The query returns D0, D1, D2, D3, D4, D5, D6, D7, D8, D9, D10, D11, D12, D13, D14, D15, CHAN1, CHAN2, CHAN3, CHAN4, or EXT.

**Format**

**Example** :COUNter:SOURce CHANnel2 /\*Sets the source of the frequency counter to CHANnel2.\*/  
:COUNter:SOURce? /\*The query returns CHAN2.\*/

## :COUNter:MODE

**Syntax** :COUNter:MODE <mode>  
:COUNter:MODE?

**Description** Sets or queries the mode of the frequency counter.

Parameter	Name	Type	Range	Default
	<mode>	Discrete	{FREQuency PERiod TOTAlize}	FREQuency

**Return Format** The query returns FREQ, PER, or TOT.

**Example** :COUNter:MODE PERiod /\*Sets the mode of the frequency counter to PERiod.\*/  
:COUNter:MODE? /\*The query returns PER.\*/

## :COUNter:NDIGits

**Syntax** :COUNter:NDIGits <val>  
:COUNter:NDIGits?

**Description** Sets or queries the resolution of the frequency counter.

Parameter	Name	Type	Range	Default
	<val>	Integer	3-6	5

**Remarks** The resolution setting is only available for "Period" and "Frequency", and unavailable for "Totalize".

**Return Format** The query returns an integer ranging from 3 to 6.

**Example** :COUNter:NDIGits 4 /\*Sets the resolution of the frequency counter to 4.\*/  
:COUNter:NDIGits? /\*The query returns 4.\*/

## :COUNter:TOTAlize:ENABLE

**Syntax** :COUNter:TOTAlize:ENABLE <bool>  
:COUNter:TOTAlize:ENABLE?

**Description** Enables or disables the statistical function of the frequency counter; or queries the on/off status of the statistical function of the frequency counter.

Parameter	Name	Type	Range	Default
	<bool>	Bool	{{1 ON} {0 OFF}}	0 OFF

**Remarks** Not available for "Period" and "Frequency".

**Return Format** The query returns 1 or 0.



**Example** :COUNter:TOTAlize:ENABle ON /\*Enables the statistical function of the  
frequency counter.\*/  
:COUNter:TOTAlize:ENABle? /\*The query returns 1.\*/

## **:COUNter:TOTAlize:CLEAr**

**Syntax** :COUNter:TOTAlize:CLEAr

**Description** Clears the total count.

**Description** Available when "Totalize" is selected under "Measure".

## :CURSor Commands

The :CURSor commands are used to measure the X axis values (e.g. Time) and Y axis values (e.g. Voltage) of the waveform on the screen.

### Command List:

- ◆ [:CURSor:MODE](#)
- ◆ [:CURSor:MANual](#)
- ◆ [:CURSor:TRACK](#)
- ◆ [:CURSor:XY](#)

**:CURSor:MODE**

**Syntax** :CURSor:MODE <mode>

:CURSor:MODE?

**Description** Sets or queries the mode of the cursor measurement.

Parameter	Name	Type	Range	Default
	<mode>	Discrete	{OFF MANual TRACk XY MEASure}	OFF

- Remarks**
- OFF: disables the cursor measurement function.
  - MANual: enables the manual mode of cursor measurement.
  - TRACk: enables the track cursor mode.
  - XY: enables the XY cursor measurement mode. This mode is valid when you select "XY" for the horizontal time base.
  - MEASure: enables the measure cursor mode.

**Return Format** The query returns OFF, MAN, TRAC, XY, or MEAS.

**Example**

```
:CURSor:MODE MANual    /*Selects the manual cursor measurement mode.*/
:CURSor:MODE?          /*The query returns MAN.*/
```

## :CURSor:MANual

### Command List:

- ◆ [:CURSor:MANual:TYPE](#)
- ◆ [:CURSor:MANual:SOURce](#)
- ◆ [:CURSor:MANual:TUNit](#)
- ◆ [:CURSor:MANual:VUNit](#)
- ◆ [:CURSor:MANual:CAX](#)
- ◆ [:CURSor:MANual:CBX](#)
- ◆ [:CURSor:MANual:CAY](#)
- ◆ [:CURSor:MANual:CBY](#)
- ◆ [:CURSor:MANual:AXValue?](#)
- ◆ [:CURSor:MANual:AYValue?](#)
- ◆ [:CURSor:MANual:BXValue?](#)
- ◆ [:CURSor:TRACk:BYValue?](#)
- ◆ [:CURSor:MANual:XDELta?](#)
- ◆ [:CURSor:MANual:IXDELta?](#)
- ◆ [:CURSor:MANual:YDELta?](#)

## :CURSor:MANual:TYPE

**Syntax** :CURSor:MANual:TYPE <type>

:CURSor:MANual:TYPE?

**Description** Sets or queries the cursor type in the manual mode of cursor measurement.

Parameter	Name	Type	Range	Default
	<type>	Discrete	{TIME AMPLitude}	TIME

- Remarks**
- TIME: indicates X cursor, which is often used to measure the time parameters.
  - AMPLitude: indicates Y cursor, which is often used to measure the voltage parameters.

**Return Format** The query returns TIME or AMPL.

**Example** :CURSor:MANual:TYPE AMPLitude /\*Sets the cursor type to AMPLitude.\*/  
:CURSor:MANual:TYPE? /\*The query returns AMPL.\*/\*

**:CURSor:MANual:SOURce**

**Syntax** :CURSor:MANual:SOURce <source>

:CURSor:MANual:SOURce?

**Description** Sets or queries the channel source of the manual mode of cursor measurement.

Parameter	Name	Type	Range	Default
	<source>	Discrete	{CHANnel1 CHANnel2 CHANnel3 CHANnel4 MATH1 MATH2 MATH3 MATH4 LA NONE}	CHANnel1

- Remarks**
- Only the currently enabled channel can be selected as the channel source.
  - When LA is selected, the cursor type cannot be set to Y (:CURSor:MANual:TYPE).

**Return Format** The query returns CHAN1, CHAN2, CHAN3, CHAN4, MATH1, MATH2, MATH3, MATH4, LA, or NONE.

**Example** :CURSor:MANual:SOURce CHANnel2 /\*Sets the channel source to CHANnel2.\*/  
:CURSor:MANual:SOURce? /\*The query returns CHAN2.\*/

**:CURSor:MANual:TUNit**

**Syntax** :CURSor:MANual:TUNit <unit>

:CURSor:MANual:TUNit?

**Description** Sets or queries the horizontal unit in the manual mode of cursor measurement.

Parameter	Name	Type	Range	Default
	<unit>	Discrete	{SECond HZ DEGRee PERCent}	SECond

- Remarks**
- SECond: in the measurement results, AX, BX, and  $\Delta X$  are expressed in "s";  $1/\Delta X$  in "Hz".
  - HZ: in the measurement results, AX, BX, and  $\Delta X$  are expressed in "Hz";  $1/\Delta X$  in "s".
  - DEGRee: in the measurement results, AX, BX, and  $\Delta X$  are expressed in "°".
  - PERCent: in the measurement results, AX, BX, and  $\Delta X$  are expressed in percentage.

**Return Format** The query returns SEC, HZ, DEGR, or PERC.

**Example** :CURSor:MANual:TUNit DEGRee /\*Sets the horizontal unit to DEGRee.\*/  
:CURSor:MANual:TUNit? /\*The query returns DEGR.\*/

**:CURSor:MANual:VUNit**

**Syntax** :CURSor:MANual:VUNit <unit>

:CURSor:MANual:VUNit?

**Description** Sets or queries the vertical unit in the manual mode of cursor measurement.

Parameter	Name	Type	Range	Default
	<unit>	Discrete	{SOURce PERCent}	SOUR

- Remarks**
- SOURce: in the measurement results, the unit of AY, BY, and  $\Delta Y$  are automatically set to the unit of the current source.
  - PERCent: in the measurement results, the unit of AY, BY, and  $\Delta Y$  are expressed in percentage.

**Return Format** The query returns SOUR or PERC.

**Example** :CURSor:MANual:VUNit PERCent /\*Sets AY, BY, and  $\Delta Y$  to be expressed in percentage in the measurement results.\*/  
 :CURSor:MANual:VUNit? /\*The query returns PERC.\*/\*

**:CURSor:MANual:CAX**

**Syntax** :CURSor:MANual:CAX <ax>

:CURSor:MANual:CAX?

**Description** Sets or queries the horizontal position of Cursor A in the manual mode of cursor measurement.

Parameter	Name	Type	Range	Default
	<ax>	Integer	0 to 999	400

**Remarks** The horizontal and vertical position of the cursor is defined by the screen pixel coordinate. The range of the screen pixel coordinate is from (0,0) to (999,479). Wherein, (0,0) is a location at the upper-left corner of the screen, and (999,479) is a location at the lower-right corner of the screen. The pixel range in the horizontal direction is from 0 to 999, and the pixel range in the vertical direction is from 0 to 479.

**Return Format** The query returns an integer ranging from 0 to 999.

**Example** :CURSor:MANual:CAX 200 /\*Sets the horizontal position of Cursor A to 200.\*/  
 :CURSor:MANual:CAX? /\*The query returns 200.\*/\*

**:CURSor:MANual:CBX**

**Syntax** :CURSor:MANual:CBX <bx>

:CURSor:MANual:CBX?

**Description** Sets or queries the horizontal position of Cursor B in the manual mode of cursor measurement.

Parameter	Name	Type	Range	Default
	<bx>	Integer	0 to 999	600

**Remarks** The horizontal and vertical position of the cursor is defined by the screen pixel coordinate. The range of the screen pixel coordinate is from (0,0) to (999,479). Wherein, (0,0) is a location at the upper-left corner of the screen, and (999,479) is a location at the lower-right corner of the screen. The pixel range in the horizontal direction is from 0 to 999, and the pixel range in the vertical direction is from 0 to 479.

**Return Format** The query returns an integer ranging from 0 to 999.

**Example** :CURSor:MANual:CBX 200 /\*Sets the horizontal position of Cursor B to 200.\*/  
:CURSor:MANual:CBX? /\*The query returns 200.\*/

**:CURSor:MANual:CAY**

**Syntax** :CURSor:MANual:CAY <ay>

:CURSor:MANual:CAY?

**Description** Sets or queries the vertical position of Cursor A in the manual mode of cursor measurement.

Parameter	Name	Type	Range	Default
	<ay>	Integer	0 to 479	180

**Remarks** ➤ The horizontal and vertical position of the cursor is defined by the screen pixel coordinate. The range of the screen pixel coordinate is from (0,0) to (999,479). Wherein, (0,0) is a location at the upper-left corner of the screen, and (999,479) is a location at the lower-right corner of the screen. The pixel range in the horizontal direction is from 0 to 999, and the pixel range in the vertical direction is from 0 to 479.

➤ When you select LA as the channel source in the manual mode of cursor measurement, this command is invalid.

**Return Format** The query returns an integer ranging from 0 to 479.

**Example** :CURSor:MANual:CAY 200 /\*Sets the vertical position of Cursor A to 200.\*/  
:CURSor:MANual:CAY? /\*The query returns 200.\*/

**:CURSor:MANual:CBY**

**Syntax** :CURSor:MANual:CBY <by>

:CURSor:MANual:CBY?

**Description** Sets or queries the vertical position of Cursor B in the manual mode of cursor measurement.

Parameter	Name	Type	Range	Default
	<by>	Integer	0 to 479	300

- Remarks**
- The horizontal and vertical position of the cursor is defined by the screen pixel coordinate. The range of the screen pixel coordinate is from (0,0) to (999,479). Wherein, (0,0) is a location at the upper-left corner of the screen, and (999,479) is a location at the lower-right corner of the screen. The pixel range in the horizontal direction is from 0 to 999, and the pixel range in the vertical direction is from 0 to 479.
  - When you select LA as the channel source in the manual mode of cursor measurement, this command is invalid.

**Return Format** The query returns an integer ranging from 0 to 479.

**Example** :CURSor:MANual:CBY 200 /\*Sets the vertical position of Cursor B to 200.\*/  
:CURSor:MANual:CBY? /\*The query returns 200.\*/

**:CURSor:MANual:AXValue?**

**Syntax** :CURSor:MANual:AXValue?

**Description** Queries the X value at Cursor A in the manual mode of cursor measurement. The unit is determined by the currently selected horizontal unit.

**Return Format** The query returns the X value at Cursor A in scientific notation.

**:CURSor:MANual:AYValue?**

**Syntax** :CURSor:MANual:AYValue?

**Description** Queries the Y value at Cursor A in the manual mode of cursor measurement. The unit is determined by the currently selected vertical unit.

- Return Format**
- When the channel source is CHANnel1, CHANnel2, CHANnel3, CHANnel4, MATH1, MATH2, MATH3, or MATH4, the query returns the Y value at Cursor A in scientific notation.
  - When the channel source is LA, the query returns a decimal integer that corresponds to the binary or hex weighted sum of the bits (D15-D0) at Cursor A. For the disabled channel, the query returns 0 by default.

**:CURSor:MANual:BXValue?**

**Syntax** :CURSor:MANual:BXValue?

**Description** Queries the X value at Cursor B in the manual mode of cursor measurement. The unit is determined by the currently selected horizontal unit.

**Return Format** The query returns the X value at Cursor B in scientific notation.



**:CURSor:MANual:BYValue?**

**Syntax** :CURSor:MANual:BYValue?

**Description** Queries the Y value at Cursor B in the manual mode of cursor measurement. The unit is determined by the currently selected vertical unit.

- Return Format**
- When the channel source is CHANnel1, CHANnel2, CHANnel3, CHANnel4, MATH1, MATH2, MATH3, or MATH4, the query returns the Y value at Cursor B in scientific notation.
  - When the channel source is LA, the query returns a decimal integer that corresponds to the binary or hex weighted sum of the bits (D15-D0) at Cursor B. For the disabled channel, the query returns 0 by default.

**Example** :CURSor:MANual:BYValue? /\*The query returns -2.000000E+0.\*/

**:CURSor:MANual:XDELta?**

**Syntax** :CURSor:MANual:XDELta?

**Description** Queries the difference ( $\Delta X$ ) between the X value at Cursor A and the X value at Cursor B in the manual mode of cursor measurement. The unit is determined by the currently selected horizontal unit.

**Return Format** The query returns the current difference in scientific notation.

**:CURSor:MANual:IXDELta?**

**Syntax** :CURSor:MANual:IXDELta?

**Description** Queries the reciprocal ( $1/\Delta X$ ) of the absolute difference between the X value at Cursor A and the X value at Cursor B in the manual mode of cursor measurement. The unit is determined by the currently selected horizontal unit.

**Return Format** The query returns  $1/\Delta X$  in scientific notation.

**:CURSor:MANual:YDELta?**

**Syntax** :CURSor:MANual:YDELta?

**Description** Queries the difference ( $\Delta Y$ ) between the Y value at Cursor A and the Y value at Cursor B in the manual mode of cursor measurement. The unit is determined by the currently selected vertical unit.

**Return Format** The query returns the current difference value in scientific notation.

## :CURSor:TRACk

### Command List:

- ◆ [:CURSor:TRACk:SOURce1](#)
- ◆ [:CURSor:TRACk:SOURce2](#)
- ◆ [:CURSor:TRACk:CAX](#)
- ◆ [:CURSor:TRACk:CBX](#)
- ◆ [:CURSor:TRACk:CAY?](#)
- ◆ [:CURSor:TRACk:CBY?](#)
- ◆ [:CURSor:TRACk:AXValue?](#)
- ◆ [:CURSor:TRACk:AYValue?](#)
- ◆ [:CURSor:TRACk:BXValue?](#)
- ◆ [:CURSor:TRACk:BYValue?](#)
- ◆ [:CURSor:TRACk:XDELta?](#)
- ◆ [:CURSor:TRACk:YDELta?](#)
- ◆ [:CURSor:TRACk:IXDELTA?](#)

## :CURSor:TRACk:SOURce1

**Syntax** :CURSor:TRACk:SOURce1 <source>  
:CURSor:TRACk:SOURce1?

**Description** Sets or queries the channel source of Cursor A in the track mode of cursor measurement.

Parameter	Name	Type	Range	Default
	<source>	Discrete	{CHANnel1 CHANnel2 CHANnel3 CHANnel4  MATH1 MATH2 MATH3 MATH4 NONE}	CHANnel1

**Remarks** Only the currently enabled channel can be selected as the channel source.

**Return Format** The query returns CHAN1, CHAN2, CHAN3, CHAN4, MATH1, MATH2, MATH3, MATH4, or NONE.

**Example** :CURSor:TRACk:SOURce1 CHANnel2     /\*Sets the channel source to CHANnel2.\*/  
:CURSor:TRACk:SOURce1?                 /\*The query returns CHAN2.\*/\*

**:CURSor:TRACk:SOURce2**

**Syntax** :CURSor:TRACk:SOURce2 <source>

:CURSor:TRACk:SOURce2?

**Description** Sets or queries the channel source of Cursor B in the track mode of cursor measurement.

Parameter	Name	Type	Range	Default
	<source>	Discrete	{CHANnel1 CHANnel2 CHANnel3 CHANnel4 MATH1 MATH2 MATH3 MATH4 NONE}	CHANnel1

**Remarks** Only the currently enabled channel can be selected as the channel source.

**Return Format** The query returns CHAN1, CHAN2, CHAN3, CHAN4, MATH1, MATH2, MATH3, MATH4, or NONE.

**Example** :CURSor:TRACk:SOURce2 CHANnel2 /\*Sets the channel source to CHANnel2.\*/  
:CURSor:TRACk:SOURce2? /\*The query returns CHAN2.\*/

**:CURSor:TRACk:CAX**

**Syntax** :CURSor:TRACk:CAX <ax>

:CURSor:TRACk:CAX?

**Description** Sets or queries the horizontal position of Cursor A in the track mode of cursor measurement.

Parameter	Name	Type	Range	Default
	<ax>	Integer	0 to 999	400

**Remarks** The horizontal and vertical position of the cursor is defined by the screen pixel coordinate. The range of the screen pixel coordinate is from (0,0) to (999,479). Wherein, (0,0) is a location at the upper-left corner of the screen, and (999,479) is a location at the lower-right corner of the screen. The pixel range in the horizontal direction is from 0 to 999, and the pixel range in the vertical direction is from 0 to 479.

**Return Format** The query returns an integer ranging from 0 to 999.

**Example** :CURSor:TRACk:CAX 200 /\*Sets the horizontal position of Cursor A to 200.\*/  
:CURSor:TRACk:CAX? /\*The query returns 200.\*/

**:CURSor:TRACk:CBX**

**Syntax** :CURSor:TRACk:CBX <bx>

:CURSor:TRACk:CBX?

**Description** Sets or queries the horizontal position of Cursor B in the track mode of cursor measurement.

Parameter	Name	Type	Range	Default
	<bx>	Integer	0 to 999	600

**Remarks** The horizontal and vertical position of the cursor is defined by the screen pixel coordinate. The range of the screen pixel coordinate is from (0,0) to (999,479). Wherein, (0,0) is a location at the upper-left corner of the screen, and (999,479) is a location at the lower-right corner of the screen. The pixel range in the horizontal direction is from 0 to 999, and the pixel range in the vertical direction is from 0 to 479.

**Return Format** The query returns an integer ranging from 0 to 999.

**Example** :CURSor:TRACk:CBX 200 /\*Sets the horizontal position of Cursor B to 200.\*/  
:CURSor:TRACk:CBX? /\*The query returns 200.\*/

**:CURSor:TRACk:CAY?**

**Syntax** :CURSor:TRACk:CAY?

**Description** Queries the vertical position of Cursor A in the track mode of cursor measurement.

**Remarks** The horizontal and vertical position of the cursor is defined by the screen pixel coordinate. The range of the screen pixel coordinate is from (0,0) to (999,479). Wherein, (0,0) is a location at the upper-left corner of the screen, and (999,479) is a location at the lower-right corner of the screen. The pixel range in the horizontal direction is from 0 to 999, and the pixel range in the vertical direction is from 0 to 479.

**Return Format** The query returns an integer.

**:CURSor:TRACk:CBY?**

**Syntax** :CURSor:TRACk:CBY?

**Description** Queries the vertical position of Cursor B in the track mode of cursor measurement.

**Remarks** The horizontal and vertical position of the cursor is defined by the screen pixel coordinate. The range of the screen pixel coordinate is from (0,0) to (999,479). Wherein, (0,0) is a location at the upper-left corner of the screen, and (999,479) is a location at the lower-right corner of the screen. The pixel range in the horizontal direction is from 0 to 999, and the pixel range in the vertical direction is from 0 to 479.

**Return Format** The query returns an integer.

**Example** :CURSor:TRACk:CBY? /\*The query returns 200.\*/

**:CURSor:TRACk:AXValue?**

**Syntax** :CURSor:TRACk:AXValue?

**Description** Queries the X value at Cursor A in the track mode of cursor measurement. The unit is determined by the amplitude unit selected for the currently corresponding channel.

**Return Format** The query returns the X value at Cursor A in scientific notation.

**:CURSor:TRACk:AYValue?**

**Syntax** :CURSor:TRACk:AYValue?

**Description** Queries the Y value at Cursor A in the track mode of cursor measurement. The unit is the same as that selected for the current channel.

**Return Format** The query returns the Y value at Cursor A in scientific notation.

**:CURSor:TRACk:BXValue?**

**Syntax** :CURSor:TRACk:BXValue?

**Description** Queries the X value at Cursor B in the track mode of cursor measurement. The unit is determined by the amplitude unit selected for the currently corresponding channel.

**Return Format** The query returns the X value at Cursor B in scientific notation.

**:CURSor:TRACk:BYValue?**

**Syntax** :CURSor:TRACk:BYValue?

**Description** Queries the Y value at Cursor B in the track mode of cursor measurement. The unit is the same as that selected for the current channel.

**Return Format** The query returns the Y value at Cursor B in scientific notation.

**:CURSor:TRACk:XDELta?**

**Syntax** :CURSor:TRACk:XDELta?

**Description** Queries the difference ( $\Delta X$ ) between the X value at Cursor A and the X value at Cursor B in the track mode of cursor measurement. The default unit is s.

**Return Format** The query returns the current difference in scientific notation.

**:CURSor:TRACk:YDELta?**

**Syntax** :CURSor:TRACk:YDELta?

**Description** Queries the difference ( $\Delta Y$ ) between the Y value at Cursor A and the Y value at Cursor B in the track mode of cursor measurement. The unit is the same as that selected for the current channel.

**Return Format** The query returns the current difference in scientific notation.

**:CURSor:TRACk:IXDELTA?**

**Syntax** :CURSor:TRACk:IXDELTA?

**Description** Queries the reciprocal ( $1/\Delta X$ ) of the absolute difference between the X value at Cursor A and the X value at Cursor B in the track mode of cursor measurement. The default unit is Hz.

**Return Format** The query returns  $1/\Delta X$  in scientific notation.

## :CURSor:XY

The :CURSor:XY command is only available when the horizontal time base mode is set to XY.

### Command List:

- ◆ [:CURSor:XY:AX](#)
- ◆ [:CURSor:XY:BX](#)
- ◆ [:CURSor:XY:AY](#)
- ◆ [:CURSor:XY:BY](#)
- ◆ [:CURSor:XY:AXValue?](#)
- ◆ [:CURSor:XY:AYValue?](#)
- ◆ [:CURSor:XY:BXValue?](#)
- ◆ [:CURSor:XY:BYValue?](#)

### :CURSor:XY:AX

**Syntax** :CURSor:XY:AX <x>  
:CURSor:XY:AX?

**Description** Sets or queries the horizontal position of Cursor A in the XY cursor measurement mode.

Parameter	Name	Type	Range	Default
	<x>	Integer	0 to 479	100

**Remarks** In the XY time base mode, the horizontal and vertical position of the cursor is defined by the pixel coordinate in the XY display region. The range of the screen pixel coordinate is from (0,0) to (479,479). Wherein, (0,0) is a location at the upper-right corner of the screen, and (479,479) is a located the lower-left corner of the screen. The pixel range in the horizontal and vertical direction is from 0 to 479.

**Return Format** The query returns an integer ranging from 0 to 479.

**Example** :CURSor:XY:AX 200 /\*Sets the horizontal position of Cursor A to 200.\*/  
:CURSor:XY:AX? /\*The query returns 200.\*/\*

**:CURSor:XY:BX**

**Syntax** :CURSor:XY:BX <x>

:CURSor:XY:BX?

**Description** Sets or queries the horizontal position of Cursor B in the XY cursor measurement mode.

Parameter	Name	Type	Range	Default
	<x>	Integer	0 to 479	300

**Remarks** In the XY time base mode, the horizontal and vertical position of the cursor is defined by the pixel coordinate in the XY display region. The range of the screen pixel coordinate is from (0,0) to (479,479). Wherein, (0,0) is a location at the upper-right corner of the screen, and (479,479) is a located the lower-left corner of the screen. The pixel range in the horizontal and vertical direction is from 0 to 479.

**Return Format** The query returns an integer ranging from 0 to 479.

**Example** :CURSor:XY:BX 200 /\*Sets the horizontal position of Cursor B to 200.\*/  
:CURSor:XY:BX? /\*The query returns 200.\*/\*

**:CURSor:XY:AY**

**Syntax** :CURSor:XY:AY <y>

:CURSor:XY:AY?

**Description** Sets or queries the vertical position of Cursor A in the XY cursor measurement mode.

Parameter	Name	Type	Range	Default
	<y>	Integer	0 to 479	100

**Remarks** In the XY time base mode, the horizontal and vertical position of the cursor is defined by the pixel coordinate in the XY display region. The range of the screen pixel coordinate is from (0,0) to (479,479). Wherein, (0,0) is a location at the upper-right corner of the screen, and (479,479) is a located the lower-left corner of the screen. The pixel range in the horizontal and vertical direction is from 0 to 479.

**Return Format** The query returns an integer ranging from 0 to 479.

**Example** :CURSor:XY:AY 200 /\*Sets the vertical position of Cursor A to 200.\*/  
:CURSor:XY:AY? /\*The query returns 200.\*/\*



**:CURSor:XY:BY****Syntax** :CURSor:XY:BY <y>

:CURSor:XY:BY?

**Description** Sets or queries the vertical position of Cursor B in the XY cursor measurement mode.**Parameter**

Name	Type	Range	Default
<y>	Integer	0 to 479	300

**Remarks** In the XY time base mode, the horizontal and vertical position of the cursor is defined by the pixel coordinate in the XY display region. The range of the screen pixel coordinate is from (0,0) to (479,479). Wherein, (0,0) is a location at the upper-right corner of the screen, and (479,479) is a located the lower-left corner of the screen. The pixel range in the horizontal and vertical direction is from 0 to 479.**Return Format** The query returns an integer ranging from 0 to 479.**Example** :CURSor:XY:BY 200 /\*Sets the vertical position of Cursor B to 200.\*/  
:CURSor:XY:BY? /\*The query returns 200.\*/**:CURSor:XY:AXValue?****Syntax** :CURSor:XY:AXValue?**Description** Queries the X value at Cursor A in the XY cursor measurement mode. The unit is determined by the amplitude unit selected for the currently corresponding channel.**Return Format** The query returns the X value at Cursor A in scientific notation.**:CURSor:XY:AYValue?****Syntax** :CURSor:XY:AYValue?**Description** Queries the X value at Cursor A in the XY cursor measurement mode. The unit is determined by the amplitude unit selected for the currently corresponding channel.**Return Format** The query returns the Y value at Cursor A in scientific notation.**:CURSor:XY:BXValue?****Syntax** :CURSor:XY:BXValue?**Description** Queries the X value at Cursor B in the XY cursor measurement mode. The unit is determined by the amplitude unit selected for the currently corresponding channel.**Return Format** The query returns the X value at Cursor B in scientific notation.**:CURSor:XY:BYValue?****Syntax** :CURSor:XY:BYValue?**Description** Queries the Y value at Cursor B in the XY cursor measurement mode. The unit is determined by the amplitude unit selected for the currently corresponding channel.**Return Format** The query returns the Y value at Cursor B in scientific notation.

## :DISPlay Commands

The :DISPlay commands can be used to set the displayed type of the waveform, persistence time, intensity, grid type, grid brightness, etc.

### Command List:

- ◆ [:DISPlay:CLEAr](#)
- ◆ [:DISPlay:TYPE](#)
- ◆ [:DISPlay:GRADing:TIME](#)
- ◆ [:DISPlay:WBRightness](#)
- ◆ [:DISPlay:GRID](#)
- ◆ [:DISPlay:GBRightness](#)
- ◆ [:DISPlay:DATA?](#)
- ◆ [:DISPlay:RUlers](#)
- ◆ [:DISPlay:COLor](#)

### :DISPlay:CLEAr

**Syntax** :DISPlay:CLEAr

**Description** Clears all the waveforms on the screen.

- Remarks**
- If the oscilloscope is in the "RUN" state, new waveforms will continue being displayed after being cleared.
  - This command functions the same as the **CLEAR** key on the front panel. You can also send the [:CLEAr](#) command to clear all the waveforms on the screen.

### :DISPlay:TYPE

**Syntax** :DISPlay:TYPE <type>

:DISPlay:TYPE?

**Description** Sets or queries the display type of the waveforms on the screen.

Parameter	Name	Type	Range	Default
	<type>	Discrete	{VECTors DOTS}	VECTors

- Remarks**
- VECTors: The sample points are connected by lines and displayed. In most cases, this mode can provide the most vivid waveform for you to view the steep edge of the waveform (such as square waveform)
  - DOTS: displays the sample points directly. You can directly view each sample point and use the cursor to measure the X and Y values of the sample point.

**Return Format** The query returns VECT or DOTS.

**Example** :DISPlay:TYPE DOTS /\*Selects the dots display mode.\*/  
:DISPlay:TYPE? /\*The query returns DOTS.\*/\*

**:DISPlay:GRADing:TIME**

**Syntax** :DISPlay:GRADing:TIME <time>

:DISPlay:GRADing:TIME?

**Description** Sets or queries the persistence time. The default unit is s.

Parameter	Name	Type	Range	Default
	<time>	Discrete	{MIN 0.1 0.2 0.5 1 2 5 10 INFinite}	MIN

- Remarks**
- MIN: sets the persistence time to its minimum value to view how the waveform changes at a high refresh rate.
  - specified value (e.g. 0.1, 0.2, 0.5, 1, 2, 5, 10): sets the persistence time to any of the above specific value to observe glitch that changes relatively slowly or glitch with low occurrence probability.
  - INFinite: In this mode, the oscilloscope displays the waveform newly acquired without clearing the waveforms acquired formerly. It can be used to measure noise and jitter and to capture incidental events.

**Return Format** The query returns MIN, 0.1, 0.2, 0.5, 1, 2, 5, 10, or INF.

**Example** :DISPlay:GRADing:TIME 0.1 /\*Sets the persistence time to 0.1 s.\*/  
:DISPlay:GRADing:TIME? /\*The query returns 0.1.\*/

**:DISPlay:WBRightness**

**Syntax** :DISPlay:WBRightness <time>

:DISPlay:WBRightness?

**Description** Sets or queries the brightness of the waveforms on the screen, expressed in percentage.

Parameter	Name	Type	Range	Default
	<time>	Integer	1 to 100	40

**Return Format** The query returns an integer ranging from 1 to 100.

**Example** :DISPlay:WBRightness 50 /\*Sets the waveform brightness to 50%.\*/  
:DISPlay:WBRightness? /\*The query returns 50.\*/

**:DISPlay:GRID**

**Syntax** :DISPlay:GRID <grid>

:DISPlay:GRID?

**Description** Sets or queries the display type of the screen grid.

Parameter	Name	Type	Range	Default
	<grid>	Discrete	{FULL HALF NONE IRE}	FULL

- Remarks**
- FULL: turns on the background grid and coordinates.
  - HALF: turns the background grid off and turns the coordinate on.
  - NONE: turns the background grid and coordinate off.
  - IRE: the IRE command is only valid when the trigger type is Video trigger and the

scale is 140 mV.

**Return Format** The query returns FULL, HALF, NONE, or IRE.

**Example** :DISPlay:GRID NONE /\*Turns off the background grid and coordinates.\*/  
:DISPlay:GRID? /\*The query returns NONE.\*/\*

## :DISPlay:GBrightness

**Syntax** :DISPlay:GBrightness <brightness>  
:DISPlay:GBrightness?

**Description** Sets or queries the brightness of the screen grid, expressed in percentage.

Parameter	Name	Type	Range	Default
	<brightness>	Integer	1 to 100	20

**Return Format** The query returns an integer ranging from 1 to 100.

**Example** :DISPlay:GBrightness 60 /\*Sets the screen grid brightness to 60%.\*/  
:DISPlay:GBrightness? /\*The query returns 60.\*/

## :DISPlay:DATA?

**Syntax** :DISPlay:DATA?

**Description** Queries the bitmap data stream of the currently displayed image.

**Return Format** The query returns the binary data stream of the screenshot in ".bmp" format.

## :DISPlay:RULers

**Syntax** :DISPlay:RULers <bool>  
:DISPlay:RULers?

**Description** Enables or disables the ruler display; or queries the on/off status of the ruler.

Parameter	Name	Type	Range	Default
	<bool>	Bool	{{1 ON}} {{0 OFF}}	0 OFF

**Return Format** The query returns 1 or 0.

**Example** :DISPlay:RULers ON /\*Enables the display of the ruler.\*/  
:DISPlay:RULers? /\*The query returns 1.\*/

**:DISPlay:COLor****Syntax** :DISPlay:COLor <val>

:DISPlay:COLor?

**Description** Enables or disables the color grade display; or queries the on/off status of the color grade display.**Parameter**

Name	Type	Range	Default
<bool>	Bool	{{1 ON} {0 OFF}}	0 OFF

**Return Format** The query returns 1 or 0.

**Example** :DISPlay:COLor ON /\*Enables the color grade display.\*/  
 :DISPlay:COLor? /\*The query returns 1.\*/\*

## :DVM Commands

### Command List:

- ◆ [:DVM:CURRent?](#)
- ◆ [:DVM:ENABle](#)
- ◆ [:DVM:SOURce](#)
- ◆ [:DVM:MODE](#)

### :DVM:CURRent?

**Syntax** :DVM:CURRent?

**Description** Queries the current voltage value under test.

### :DVM:ENABle

**Syntax** :DVM:ENABle <bool>

:DVM:ENABle?

**Description** Enables or disables the digital voltmeter; or queries the on/off status of the digital voltmeter.

Parameter	Name	Type	Range	Default
	<bool>	Bool	{{1 ON}} {{0 OFF}}	0 OFF

**Return Format** The query returns 1 or 0.

**Example** :DVM:ENABle ON /\*Enables the digital voltmeter.\*/  
:DVM:ENABle? /\*The query returns 1.\*/\*

### :DVM:SOURce

**Syntax** :DVM:SOURce <source>

:DVM:SOURce?

**Description** Sets or queries the source of the digital voltmeter.

Parameter	Name	Type	Range	Default
	<source>	Discrete	{CHANnel1 CHANnel2 CHANnel3 CHANnel4}	CHANnel1

**Return Format** The query returns CHAN1, CHAN2, CHAN3, or CHAN4.

**Example** :DVM:SOURce CHANnel1 /\*Sets the source of DVM to CHANnel1.\*/  
:DVM:SOURce? /\*The query returns CHAN1.\*/\*

**:DVM:MODE**

**Syntax** :DVM:MODE <mode>

:DVM:MODE?

**Description** Sets or queries the mode of the digital voltmeter.

Parameter	Name	Type	Range	Default
	<mode>	Discrete	{ACRMs DC DCRMs}	ACRMs

- Description**
- ACRMs: displays the root-mean-square value of the acquired data, with the DC component removed.
  - DC: displays the average value of the acquired data.
  - DCRMs: displays the root-mean-square value of the acquired data.

**Return Format** The query returns ACRM, DC, or DCRM.

**Example**

```
:DVM:MODE DC          /*Sets the mode of the digital voltmeter to DC.*/
:DVM:MODE?            /*The query returns DC.*/
```

## :EYE Commands

### Command List:

- ◆ [:EYE:ENABle](#)
- ◆ [:EYE:SOURce](#)
- ◆ [:EYE:MEASure:ENABle](#)
- ◆ [:EYE:MEASure:ITEM](#)

### :EYE:ENABle

**Syntax** :EYE:ENABle <bool>

:EYE:ENABle?

**Description** Enables or disables the eye analysis function; or queries the on/off status of the eye analysis function.

Parameter	Name	Type	Range	Default
	<bool>	Bool	{{1 ON}} {{0 OFF}}	0 OFF

**Return Format** The query returns 1 or 0.

**Example** :EYE:ENABle ON /\*Enables the eye analysis function.\*/  
:EYE:ENABle? /\*The query returns 1.\*/\*

### :EYE:SOURce

**Syntax** :EYE:SOURce <source>

:EYE:SOURce?

**Description** Sets or queries the source of the eye diagram.

Parameter	Name	Type	Range	Default
	<source>	Discrete	{CHANnel1 CHANnel2 CHANnel3 CHANnel4}	CHANnel1

**Return Format** The query returns CHAN1, CHAN2, CHAN3, or CHAN4.

**Example** :DVM:SOURce CHANnel3 /\*Sets the source of eye diagram to CHANnel3.\*/  
:DVM:SOURce? /\*The query returns CHAN3.\*/\*



**:EYE:MEASure:ENABLE**

**Syntax** :EYE:MEASure:ENABLE <bool>

:EYE:MEASure:ENABLE?

**Description** Enables or disables the eye measurement; or queries the on/off status of the eye measurement.

Parameter	Name	Type	Range	Default
	<bool>	Bool	{{1 ON} {0 OFF}}	0 OFF

**Return Format** The query returns 1 or 0.

**Example** :EYE:MEASure:ENABLE ON /\*Enables the eye measurement.\*/  
:EYE:MEASure:ENABLE? /\*The query returns 1.\*/\*

**:EYE:MEASure:ITEM**

**Syntax** :EYE:MEASure:ITEM? <item>

**Description** Queries the measurements of an eye diagram.

Parameter	Name	Type	Range	Default
	<item>	Discrete	{ONE ZERO WIDTH HEIGth AMP CROSSs QFACTor}	--

**Remarks** ONE: indicates "1" level.  
ZERO: indicates "0" level.  
WIDTH: indicates the width of an eye diagram.  
HEIGth: indicates the height of an eye diagram.  
AMP: indicates the amplitude of an eye diagram.  
CROSSs: indicates the crossing percentage of an eye diagram.  
QFACTor: indicates the Q factor.

**Return Format** The query returns the measurements of an eye diagram in scientific notation.

**Example** :EYE:MEASure:ITEM? AMP /\* Queries the amplitude of an eye diagram and returns 1.004000E0\*/

## :HISTogram Commands

### Command List:

- ◆ [:HISTogram:DISPlay](#)
- ◆ [:HISTogram:TYPE](#)
- ◆ [:HISTogram:SOURce](#)
- ◆ [:HISTogram:SIZE](#)
- ◆ [:HISTogram:STATic](#)
- ◆ [:HISTogram:RESet](#)
- ◆ [:HISTogram:BLIMit](#)
- ◆ [:HISTogram:LLIMit](#)
- ◆ [:HISTogram:RLIMit](#)
- ◆ [:HISTogram:TLIMit](#)

### :HISTogram:DISPlay

**Syntax** :HISTogram:DISPlay <bool>

:HISTogram:DISPlay?

**Description** Enables or disables the histogram function; or queries the status of the histogram.

Parameter	Name	Type	Range	Default
	<bool>	Bool	{{1 ON} {0 OFF}}	0 OFF

**Return Format** The query returns 1 or 0.

**Example** :HISTogram:DISPlay ON /\*Enables the histogram.\*/  
:HISTogram:DISPlay? /\*The query returns 1.\*/

### :HISTogram:TYPE

**Syntax** :HISTogram:TYPE <type>

:HISTogram:TYPE?

**Description** Sets or queries the type of the histogram.

Parameter	Name	Type	Range	Default
	<type>	Discrete	{HORizontal VERTical MEAS}	HORizontal

**Return Format** The query returns HOR, VERT, or MEAS.

**Example** :HISTogram:TYPE VERTICAL /\*Sets the type of the histogram to VERTICAL.\*/  
:HISTogram:TYPE? /\*The query returns VERT.\*/

**:HISTogram:SOURce**

**Syntax** :HISTogram:SOURce <source>

:HISTogram:SOURce?

**Description** Sets or queries the source of the histogram.

Parameter	Name	Type	Range	Default
	<source>	Discrete	{CHANnel1 CHANnel2 CHANnel3 CHANnel4 MATH1 MATH2 MATH3 MATH4 OFF}	OFF

**Return Format** The query returns CHAN1, CHAN2, CHAN3, CHAN4, MATH1, MATH2, MATH3, MATH4, or OFF.

**Example** :HISTogram:SOURce CHANnel2

/\*Sets the source of the histogram to CHANnel2.\*/

:HISTogram:SOURce?

/\*The query returns CHAN2.\*/

**:HISTogram:SIZE**

**Syntax** :HISTogram:SIZE <size>

:HISTogram:SIZE?

**Description** Sets or queries the height of the histogram.

Parameter	Name	Type	Range	Default
	<size>	Integer	1 to 4	1

**Return Format** The query returns an integer ranging from 1 to 4.

**Example** :HISTogram:SIZE 2

/\*Sets the height of the histogram to 2.\*/

:HISTogram:SIZE?

/\*The query returns 2.\*/

**:HISTogram:STATIC**

**Syntax** :HISTogram:STATIC <bool>

:HISTogram:STATIC?

**Description** Enables or disables the statistical function; or queries the status of the statistical function.

Parameter	Name	Type	Range	Default
	<bool>	Bool	{{1 ON}} {{0 OFF}}	0 OFF

**Return Format** The query returns 1 or 0.

**Example** :HISTogram:STATIC ON

/\*Enables the statistical function.\*/

:HISTogram:STATIC?

/\*The query returns 1.\*/

## :HISTogram:RESet

**Syntax** :HISTogram:RESet

**Description** Resets the statistics.

## :HISTogram:BLIMit

**Syntax** :HISTogram:BLIMit <y>

:HISTogram:BLIMit?

**Description** Sets or queries the histogram's bottom boundary limit.

**Parameter**

Name	Type	Range	Default
<y>	Real	(-4×VerticalScale) to (4×VerticalScale) (vertical scale of the channel source of the histogram)	0 V

**Return Format** The query returns the histogram's bottom boundary limit in scientific notation.

**Example** :HISTogram:BLIMit -2 /\*Sets the histogram's bottom boundary limit to -2 mV.\*/  
:HISTogram:BLIMit? /\*The query returns -2.000000E0.\*/

## :HISTogram:LLIMit

**Syntax** :HISTogram:LLIMit <x>

:HISTogram:LLIMit?

**Description** Sets or queries the histogram's left boundary limit.

**Parameter**

Name	Type	Range	Default
<x>	Real	(-5×Horizontal Time Base) to (5×Horizontal Time Base)	0 V

**Return Format** The query returns the histogram's left boundary limit in scientific notation.

**Example** :HISTogram:LLIMit -2 /\*Sets the histogram's left boundary limit to -2 mV.\*/  
:HISTogram:LLIMit? /\*The query returns -2.000000E0.\*/

## :HISTogram:RLIMit

**Syntax** :HISTogram:RLIMit <x>

:HISTogram:RLIMit?

**Description** Sets or queries the histogram's right boundary limit.

**Parameter**

Name	Type	Range	Default
<x>	Real	(-5×Horizontal Scale) to (5×Horizontal Scale)	0 V

**Return Format** The query returns the histogram's right boundary limit in scientific notation.

**Example** :HISTogram:RLIMit -2 /\*Sets the histogram's right boundary limit to -2 mV.\*/  
:HISTogram:RLIMit? /\*The query returns -2.000000E0.\*/

**:HISTogram:TLIMit****Syntax** :HISTogram:TLIMit <y>

:HISTogram:TLIMit?

**Description** Sets or queries the histogram's top boundary limit.**Parameter**

Name	Type	Range	Default
<y>	Real	(-4×VerticalScale) to (4×VerticalScale) (vertical scale of the channel source of the histogram)	0 V

**Return Format**

The query returns the histogram's top boundary limit in scientific notation.

**Example**

:HISTogram:TLIMit -2

/\*Sets the histogram's top boundary limit to -2 mV.\*/

:HISTogram:TLIMit?

/\*The query returns -2.000000E0.\*/

## IEEE488.2 Common Commands

The IEEE488.2 common commands are used to query the basic information of the instrument or executing basic operations. These commands usually start with "\*", and the keywords in a command contain 3 characters.

### Command List:

- ◆ [\\*CLS](#)
- ◆ [\\*ESE](#)
- ◆ [\\*ESR?](#)
- ◆ [\\*IDN?](#)
- ◆ [\\*OPC](#)
- ◆ [\\*SAV](#)
- ◆ [\\*RCL](#)
- ◆ [\\*RST](#)
- ◆ [\\*SRE](#)
- ◆ [\\*STB?](#)
- ◆ [\\*TST?](#)
- ◆ [\\*WAI](#)

### \*CLS

**Syntax** \*CLS

**Description** Clears all the event registers, and also clears the error queue.

### \*ESE

**Syntax** \*ESE <maskargument>

\*ESE?

**Description** Sets or queries the enable register bit of the standard event register set.

Parameter	Name	Type	Range	Default
	<maskargument>	Integer	0 to 255	0

**Return Format** The query returns an integer. The integer equals to the binary-weighted sum of all the bits set in the register.

**Example** \*ESE 16 /\*Enables Bit 4 (16 in decimal) in the register.\*/  
\*ESE? /\*The query returns the enable value of the register 16.\*/\*

### \*ESR?

**Syntax** \*ESR?

**Description** Queries and clears the event register of the standard event status register.

**Remarks** Bit 1 and Bit 6 in the standard event status register are not used and are always treated

as 0; therefore, the range of the returned value is a decimal number corresponding to a binary number X0XXXX0X (X is 1 or 0).

**Return Format** The query returns an integer. The integer equals to the binary-weighted sum of all the bits set in the register.

## \*IDN?

**Syntax** \*IDN?

**Description** Queries the ID string of the instrument.

**Return Format** The query returns RIGOL TECHNOLOGIES,<model>,<serial number>,<software version>.  
Wherein,  
<model>: indicates the model number of the instrument.  
<serial number>: indicates the serial number of the instrument.  
<software version>: indicates the software version of the instrument.

## \*OPC

**Syntax** \*OPC  
\*OPC?

**Description** The \*OPC command sets bit 0 (Operation Complete, OPC) in the standard event status register to 1 after the current operation is finished. The OPC? command queries whether the current operation is finished.

**Return Format** The query returns 1 after the current operation is finished; otherwise, the query returns 0.

## \*SAV

**Syntax** \*SAV <value>

**Description** Saves the current instrument state to the selected register.

**Parameter**

Name	Type	Range	Default
<value>	Integer	0 to 49	0

**Example** \*SAV 1 /\*Saves the current instrument state to Register 1.\*/

## \*RCL

**Syntax** \*RCL

**Description** Recalls the instrument state in the specified location.

## \*RST

**Syntax** \*RST

**Description** Restores the instrument to its factory default settings.

**\*SRE**

**Syntax** \*SRE <maskargument>

\*SRE?

**Description** Sets or queries the enable register of the status byte register set.

Parameter	Name	Type	Range	Default
	<maskargument>	Integer	0 to 255	0

**Remarks** This command queries the standard event enable register value. Bit 3 and Bit 6 in the standard event status register are not used and are always treated as 0. Therefore, the range of <maskargument> is a decimal that corresponds to a binary number X0XX0XXX (X is 1 or 0).

**Return Format** The query returns an integer. The integer equals to the binary-weighted sum of all the bits set in the register.

**Example** \*SRE 16 /\*Enables Bit 4 (16 in decimal) in the register.\*/  
\*SRE? /\*The query returns the enable value of the register 16.\*/

**\*STB?**

**Syntax** \*STB?

**Description** Queries the event register for the status byte register. After executing the command, the value in the status byte register is cleared.

**Remarks** Bit 0 and Bit 1 in the status byte register are not used and are always treated as 0; therefore, the range of the returned value is a decimal number corresponding to a binary number X0XXXX0X (X is 1 or 0).

**Return Format** The query returns an integer. The integer equals to the binary-weighted sum of all the bits set in the register.

**\*TST?**

**Syntax** \*TST?

**Description** Performs a self-test and queries the self-test result.

**Return Format** The query returns a decimal integer.

**\*WAI**

**Syntax** \*WAI

**Description** Waits for all the pending operations to complete before executing any additional commands.

**Remarks** This operation command does not have any functions, only to be compatible with other devices.



## :JITTer Commands

### Command List:

- ◆ [:JITTer:ENABle](#)
- ◆ [:JITTer:SOURce](#)
- ◆ [:JITTer:HISTogram:APPLy](#)
- ◆ [:JITTer:TREND:APPLy](#)
- ◆ [:JITTer:MEASure:TYPE](#)
- ◆ [:JITTer:MEASure:ITEM](#)
- ◆ [:JITTer:MEASure:STATistic:ITEM](#)
- ◆ [:JITTer:MEASure:ENABle](#)
- ◆ [:JITTer:SLOPe](#)

### :JITTer:ENABle

**Syntax** :JITTer:ENABle <bool>

:JITTer:ENABle?

**Description** Enables or disables the jitter analysis function; or queries the on/off status of the jitter analysis function.

Parameter	Name	Type	Range	Default
	<bool>	Bool	{{1 ON}} {{0 OFF}}	0 OFF

**Return Format** The query returns 1 or 0.

**Example** :JITTer:ENABle ON /\*Enables the jitter analysis function.\*/  
:JITTer:ENABle? /\*The query returns 1.\*/\*

### :JITTer:SOURce

**Syntax** :JITTer:SOURce <source>

:JITTer:SOURce?

**Description** Sets or queries the source of the jitter.

Parameter	Name	Type	Range	Default
	<source>	Discrete	{CHANnel1 CHANnel2 CHANnel3 CHANnel4}	CHANnel1

**Return Format** The query returns CHAN1, CHAN2, CHAN3, or CHAN4.

**Example** :JITTer:SOURce CHANnel3 /\*Sets the source of the jitter to CHANnel3.\*/  
:JITTer:SOURce? /\*The query returns CHAN3.\*/\*

**:JITTer:HISTogram:APPLY****Syntax** :JITTer:HISTogram:APPLY <bool>

:JITTer:HISTogram:APPLY?

**Description** Enables or disables the jitter histogram; or queries the on/off status of the jitter histogram.

Parameter	Name	Type	Range	Default
	<bool>	Bool	{{1 ON} {0 OFF}}	0 OFF

**Return Format** The query returns 1 or 0.

**Example** :JITTer:HISTogram:APPLY ON /\*Enables the jitter histogram.\*/  
 :JITTer:HISTogram:APPLY? /\*The query returns 1.\*/

**:JITTer:TREND:APPLY****Syntax** :JITTer:TREND:APPLY <bool>

:JITTer:TREND:APPLY?

**Description** Enables or disables the jitter trend graph; or queries the on/off status of the jitter trend graph.

Parameter	Name	Type	Range	Default
	<bool>	Bool	{{1 ON} {0 OFF}}	0 OFF

**Return Format** The query returns 1 or 0.

**Example** :JITTer:TREND:APPLY ON /\*Enables the jitter trend graph.\*/  
 :JITTer:TREND:APPLY? /\*The query returns 1.\*/

**:JITTer:MEASure:TYPE****Syntax** :JITTer:MEASure:TYPE<item>

:JITTer:MEASure:TYPE?

**Description** Sets or queries the measurement item of the jitter.

Parameter	Name	Type	Range	Default
	<item>	Discrete	{TIE CYC POS NEG}	TIE

**Return Format** The query returns TIE, CYC, POS, or NEG.

**Example** :JITTer:MEASure:TYPE TIE /\*Sets the measurement item of the jitter to TIE.\*/  
 :JITTer:MEASure:TYPE? /\*The query returns TIE.\*/

**:JITTer:MEASure:ITEM**

**Syntax** :JITTer:MEASure:ITEM <item>[,<source>]  
:JITTer:MEASure:ITEM? <item>[,<source>]

**Description** Sets or queries the jitter measurement item of the specified channel.

Parameter	Name	Type	Range	Default
	<item>	Discrete	{TIE CYC POS NEG}	TIE
	<source>	Discrete	{CHANnel1 CHANnel2 CHANnel3 CHANnel4}	CHANnel1

**Remarks** This command is only valid when the jitter analysis function is enabled.

**Return Format** The query returns the jitter measurement item of the specified channel in scientific notation.

**Example** :JITTer:MEASure:ITEM TIE,CHANnel1  
/\*Sets the jitter measurement item of CH1 to TIE.\*/  
:JITTer:MEASure:ITEM? TIE,CHANnel1  
/\*The query returns 9.900000E+37.\*/\*

**:JITTer:MEASure:STATistic:ITEM**

**Syntax** :JITTer:MEASure:STATistic:ITEM? <type>,<item>[,<source>]

**Description** Sets or queries the statistics value of the jitter measurement item for the specified channel.

Parameter	Name	Type	Range	Default
	<type>	Discrete	{MAXimum MINimum CURRENT AVERages SDE Viation CNT}	---
	<item>	Discrete	{TIE CYC POS NEG}	TIE
	<source>	Discrete	{CHANnel1 CHANnel2 CHANnel3 CHANnel4}	CHANnel1

**Remarks** This command is only valid when the jitter analysis function is enabled.

**Return Format** The query returns the statistics value of the jitter measurement item in scientific notation.

**Example** :JITTer:MEASure:STATistic:ITEM? MAXimum,TIE,CHANnel1  
/\*The query returns the maximum value of the measurement item TIE for CH1.\*/\*

**:JITTer:MEASure:ENABLE**

**Syntax** :JITTer:MEASure:ENABLE <bool>  
:JITTer:MEASure:ENABLE?

**Description** Enables or disables the jitter measurement; or queries the on/off status of the jitter measurement.

Parameter	Name	Type	Range	Default
	<bool>	Bool	{{1 ON}} {{0 OFF}}	0 OFF

**Return Format** The query returns 1 or 0.

**Example** :JITter:MEASure:ENABLE ON /\*Enables the jitter measurement.\*/  
 :JITter:MEASure:ENABLE? /\*The query returns 1.\*/

## :JITter:SLOPe

**Syntax** :JITter:SLOPe <slope>  
 :JITter:SLOPe?

**Description** Sets or queries the edge of the jitter measurement item.

Parameter	Name	Type	Range	Default
	<slope>	Discrete	{POSitive NEGative RFALI}	POSitive

**Remarks** When the measurement item is "TIE" or "Cycle to Cycle", you need to set the edge of the measurement signal.

**Return Format** The query returns POS, NEG, or RFAL.

**Example** :JITter:SLOPe POSitive  
 /\*Sets the edge of the jitter measurement item to POSitive.\*/  
 :JITter:SLOPe?  
 /\*The query returns POS.\*/

## :LA Commands

The :LA commands are used to perform relevant operations on the digital channels. The commands are only available for the model installed with the MSO8000-MSO option.

### Command List:

- ◆ [:LA:STATe](#)
- ◆ [:LA:ACTive](#)
- ◆ [:LA:AUTOsort](#)
- ◆ [:LA:DELeTe](#)
- ◆ [:LA:DIgital:DISPlay](#)
- ◆ [:LA:DIgital:POSition](#)
- ◆ [:LA:DIgital:LABel](#)
- ◆ [:LA:POD<n>:DISPlay](#)
- ◆ [:LA:DISPlay](#)
- ◆ [:LA:POD<n>:THReshold](#)
- ◆ [:LA:SIZE](#)
- ◆ [:LA:TCALibrate](#)
- ◆ [:LA:GROup:APPend](#)

### :LA:STATe

**Syntax** :LA:STATe <bool>

:LA:STATe?

**Description** Enables or disables LA function; or queries the on/off status of LA function.

#### Parameter

Name	Type	Range	Default
<bool>	Bool	{{1 ON}} {{0 OFF}}	0 OFF

**Return Format** The query returns 1 or 0.

**Example** :LA:STATe ON /\*Enables LA function.\*/  
:LA:STATe? /\*The query returns 1.\*/\*

**:LA:ACTive****Syntax** :LA:ACTive {<digital>|NONE}

:LA:ACTive?

**Description** Sets or queries the current active channel or channel group.

Parameter	Name	Type	Range	Default
	<digital>	Discrete	{D0 D1 D2 D3 D4 D5 D6 D7 D8 D9 D10 D11 D12 D13 D14 D15 NONE}	---

- Remarks**
- The parameter <digital> can be any of the digital channels (D0-D15). The channel label and waveform of the selected channel are displayed in red.
  - When you send the parameter NONE, it means that no channel is selected.
  - Only the currently enabled digital channel can be selected. Please refer to the [:LA:DIGital:DISPlay](#) command or the [:LA:DISPlay](#) command to enable the desired channel.

**Return Format** The query returns the current active channel (D0, D1, ...D15) or NONE.

**Example** :LA:ACTive D3 /\*Sets the current active channel to D3.\*/  
 :LA:ACTive? /\*The query returns D3.\*/

**:LA:AUTOsort****Syntax** :LA:AUTOsort <n>**Description** Sets the auto sorting mode for the waveforms of the currently selected channels on the screen.

Parameter	Name	Type	Range	Default
	<n>	Discrete	{0 1}	1

- Remarks**
- <n> = 0: the waveforms on the screen are D0-D15 in sequence from top to bottom.
  - <n> = 1: the waveforms on the screen are D15-D0 in sequence from top to bottom.

**:LA:DELeTe****Syntax** :LA:DELeTe <group>**Description** Cancels the group setting for the 16 digital channels, or cancels the group settings for the channel groups (GROUP1-GROUP4).

Parameter	Name	Type	Range	Default
	<group>	Discrete	{GROUP1 GROUP2 GROUP3 GROUP4}	---

**Remarks** This command only performs the canceling operation for digital channels or user-defined channel group that have been group set.

**:LA:DIgital:DISPlay**

**Syntax** :LA:DIgital:DISPlay <digital>,<bool>

:LA:DIgital:DISPlay? <digital>

**Description** Turns on or off the specified digital channel; or queries the on/off status of the specified digital channel.

Parameter	Name	Type	Range	Default
	<digital>	Integer	{D0 D1 D2 D3 D4 D5 D6 D7 D8 D9 D10 D11 D12 D13 D14 D15}	---
	<bool>	Bool	{{1 ON}} {0 OFF}}	0 OFF

**Remarks** The currently enabled channel can be selected as the active channel by sending the [:LA:ACTive](#) command.

**Return Format** The query returns 1 or 0.

**Example** :LA:DIgital:DISPlay D3,ON /\*Enables D3.\*/  
:LA:DIgital:DISPlay? D3 /\*The query returns 1.\*/\*

**:LA:DIgital:POSition**

**Syntax** :LA:DIgital:POSition <digital>,<position>

:LA:DIgital:POSition? <digital>

**Description** Sets or queries the position of the displayed waveforms of the specified digital channel on the screen.

Parameter	Name	Type	Range	Default
	<digital>	Integer	{D0 D1 D2 D3 D4 D5 D6 D7 D8 D9 D10 D11 D12 D13 D14 D15}	---
	<position>	Integer	When the waveform display size is Small: 0 to 31 When the waveform display size is Medium: 0 to 15 When the waveform display size is Large: 0 to 7	---

**Remarks**

- The value of the parameter <position> indicates the position of the waveforms displayed on the screen.
- This setting command is only valid when the specified digital channel is currently enabled.

**Return Format** The query returns an integer ranging from 0 to 31, 0 to 15, or from 0 to 7.

**Example** :LA:DIgital:POSition D1,3 /\*Sets the displayed position of D1 to 3.\*/  
:LA:DIgital:POSition? D1 /\*The query returns 3.\*/\*

**:LA:DIGital:LABel**

**Syntax** :LA:DIGital:LABel <digital>,<label>

:LA:DIGital:LABel? <digital>

**Description** Sets or queries the label of the specified digital channel.

Parameter	Name	Type	Range	Default
	<digital>	Integer	{D0 D1 D2 D3 D4 D5 D6 D7 D8 D9 D10 D11 D12 D13 D14 D15}	---
	<label>	ASCII String	The label can contain English letters and numbers, as well as some symbols.	---

**Return Format** The query returns the label of the specified digital channel in ASCII strings.

**Example** :LA:DIGital:LABel D0,ACK /\*Sets the label of D0 to ACK.\*/  
:LA:DIGital:LABel? D0 /\*The query returns ACK.\*/

**:LA:POD<n>:DISPlay**

**Syntax** :LA:POD<n>:DISPlay <bool>

:LA:POD<n>:DISPlay?

**Description** Enables or disables the specified default channel group; or queries the on/off status of the specified default channel group.

Parameter	Name	Type	Range	Default
	<n>	Integer	1 to 2	---
	<bool>	Bool	{{1 ON}} {0 OFF}}	---

**Remarks** 2 default channel groups: POD1 (D0 to D7) and POD2 (D8 to D15).

**Return Format** The query returns 1 or 0.

**Example** :LA:POD1:DISPlay 1 /\*Enables POD1 (D0 to D7).\*/  
:LA:POD1:DISPlay? /\*The query returns 1.\*/

**:LA:DISPlay**

**Syntax** :LA:DISPlay <channel>,<bool>

:LA:DISPlay? <channel>

**Description** Turns on or off the specified digital channel, user-defined channel group, or the default channel group; or queries the on/off status of the specified digital channel, user-defined channel group, or the default channel group.

Parameter	Name	Type	Range	Default
	<channel>	Discrete	{D0 D1 D2 D3 D4 D5 D6 D7 D8 D9 D10 D11 D12 D13 D14 D15 GROup1 GROup2 GROup3 GROup4 POD1 POD2}	---
	<bool>	Bool	{{1 ON}} {0 OFF}}	---

**Remarks** ➤ You can set the digital channels contained in the specified user-defined channel group. Note that any one of the digital channels can only belong to one of the



specified user-defined channel group.

- The currently enabled channel or user-defined channel group can be selected as the active channel or the channel group by sending the [:LA:ACTive](#) command.
- POD1: D0 to D7; POD2: D8 to D15

**Return Format** The query returns 1 or 0.

**Example** :LA:DISPlay D0,ON /\*Enables D0.\*/  
:LA:DISPlay? D0 /\*The query returns 1.\*/\*

## :LA:POD<n>:THReshold

**Syntax** :LA:POD<n>:THReshold <thre>  
:LA:POD<n>:THReshold?

**Description** Sets or queries the threshold of the specified default channel group. The default unit is V.

Parameter	Name	Type	Range	Default
	<n>	Integer	1 to 2	---
	<thre>	Real	-20.0 V to +20.0 V	1.40V

**Remarks** 2 default channel groups: POD1 (D0 to D7) or POD2 (D8 to D15).

**Return Format** The query returns the current threshold of the specified channel group in scientific notation.

**Example** :LA:POD1:THReshold 3.3 /\*Sets the threshold of POD1 (D0 to D7) to 3.3 V.\*/  
:LA:POD1:THReshold? /\*The query returns 3.300000E0.\*/\*

## :LA:SIZE

**Syntax** :LA:SIZE <size>  
:LA:SIZE?

**Description** Sets or queries the size of the waveforms of the enabled channel on the screen.

Parameter	Name	Type	Range	Default
	<size>	Discrete	{SMALI LARGe MEDIum}	MEDIum

**Remarks** L (large) can only be used when the number of the currently enabled channels is no more than 8.

**Return Format** The query returns SMAL, LARG, or MED.

**Example** :LA:SIZE SMALI /\*Sets the waveform display size to SMALI.\*/  
:LA:SIZE? /\*The query returns SMAL.\*/\*

## :LA:TCALibrate

**Syntax** :LA:TCALibrate <tcal>

:LA:TCALibrate?

**Description** Sets or queries the delay calibration time of the digital channel. The default unit is s.

**Parameter**

Name	Type	Range	Default
<tcal>	Real	-1000 ns to 100 ns	0.00 s

**Remarks** When you use an oscilloscope to make actual measurements, the transmission delay of the probe cable may bring relatively greater errors (zero offset). Zero offset is defined as the offset of the crossing point (between the waveforms and the threshold level) from the trigger position. You can set a delay time for calibrating the zero offset of the corresponding channel.

**Return Format** The query returns the delay calibration time in scientific notation.

**Example** :LA:TCALibrate 0.00000002 /\*Sets the delay calibration time to 20 ns.\*/  
:LA:TCALibrate? /\*The query returns 2.000000E-8.\*/

## :LA:GRoUp:APPend

**Syntax** :LA:GRoUp:APPend

```
<group>,<digital0>[,<digital1>[,<digital2>[,<digital3>[,<digital4>[,<digital5>[,<digital6>[,<digital7>[,<digital8>[,<digital9>[,<digital10>[,<digital11>[,<digital12>[,<digital13>[,<digital14>[,<digital15>]]]]]]]]]]]]]
```

**Description** Adds a channel to the specified user-defined group.

**Parameter**

Name	Type	Range	Default
<group>	Discrete	{GRoUp1 GRoUp2 GRoUp3 GRoUp4}	---
<digital0>/<digital1>/ <digital2>/<digital3>/ <digital4>/<digital5>/ <digital6>/<digital7>/ <digital8>/<digital9>/ <digital10>/<digital11>/ <digital12>/<digital13>/ <digital14>/<digital15>]	Discrete	{D0 D1 D2 D3 D4 D5 D6 D7 D8 D9 D10 D11 D12 D13 D14 D15}	---

**Example** :LA:GRoUp:APPend GRoUp2,D0,D1 /\*Adds D0 and D1 to Group2.\*/

## :LAN Commands

The :LAN commands are used to set and query the LAN parameters.

- ◆ [:LAN:DHCP](#)
- ◆ [:LAN:AUTOip](#)
- ◆ [:LAN:GATeway](#)
- ◆ [:LAN:DNS](#)
- ◆ [:LAN:MAC?](#)
- ◆ [:LAN:DSErver?](#)
- ◆ [:LAN:MANual](#)
- ◆ [:LAN:IPADdress](#)
- ◆ [:LAN:SMASk](#)
- ◆ [:LAN:STATus?](#)
- ◆ [:LAN:VISA?](#)
- ◆ [:LAN:MDNS](#)
- ◆ [:LAN:HOST:NAME](#)
- ◆ [:LAN:DESCription](#)
- ◆ [:LAN:APPLY](#)

### :LAN:DHCP

**Syntax** :LAN:DHCP <bool>

:LAN:DHCP?

**Description** Turns on or off the DHCP configuration mode; or queries the on/off status of the current DHCP configuration mode.

Parameter	Name	Type	Range	Default
	<bool>	Bool	{{1 ON} {0 OFF}}	1 ON

- Remarks**
- When the three IP configuration types (DHCP, Auto IP, and Static IP) are all turned on, the priority of the parameter configuration from high to low is "DHCP", "Auto IP", and "Static IP". The three IP configuration types cannot be all turned off at the same time.
  - When DHPC is valid, the DHCP server in the current network will assign the network parameters (such as the IP address) for the oscilloscope.
  - After the [:LAN:APPLY](#) command is executed, the configuration type can take effect immediately.

**Return Format** The query returns 1 or 0.

**Example**

```
:LAN:DHCP OFF /*Disables DHCP configuration mode.*/
:LAN:DHCP? /*The query returns 0.*/
```

**:LAN:AUTOip****Syntax** :LAN:AUTOip <bool>

:LAN:AUTOip?

**Description** Turns on or off the Auto IP configuration mode; or queries the on/off status of the current Auto IP configuration mode.

Parameter	Name	Type	Range	Default
	<bool>	Bool	{{1 ON} {0 OFF}}	1 ON

**Remarks** When the auto IP mode is valid, disable DHCP manually. You can self-define the gateway and DNS address for the oscilloscope.**Return Format** The query returns 1 or 0.**Example** :LAN:AUTOip OFF /\*Disables the Auto IP configuration mode.\*/  
:LAN:AUTOip? /\*The query returns 0.\*/\***:LAN:GATeway****Syntax** :LAN:GATeway <string>

:LAN:GATeway?

**Description** Sets or queries the default gateway.

Parameter	Name	Type	Range	Default
	<string>	ASCII String	Refer to <b>Remarks</b>	---

**Remarks**

- The format of <string> is nnn,nnn,nnn,nnn. The range of the first section of "nnn" is from 0 to 223 (except 127), and the ranges of the other three sections of "nnn" are from 0 to 255.
- When you use this command, the IP configuration mode should be Auto IP or Static IP mode.

**Return Format** The query returns the current gateway in strings.**Example** :LAN:GATeway 192.168.1.1 /\*Sets the default gateway to 192.168.1.1.\*/  
:LAN:GATeway? /\*The query returns the current gateway.\*/\***:LAN:DNS****Syntax** :LAN:DNS <string>

:LAN:DNS?

**Description** Sets or queries the DNS address.

Parameter	Name	Type	Range	Default
	<string>	ASCII String	Refer to <b>Remarks</b>	---

**Remarks**

- The format of <string> is nnn,nnn,nnn,nnn. The range of the first section of "nnn" is from 0 to 223 (except 127), and the ranges of the other three sections of "nnn" are from 0 to 255.
- When you use this command, the IP configuration mode should be Auto IP or Static IP mode.

**Return Format** The query returns the current DNS address in strings.

**Example** :LAN:DNS 192.168.1.1 /\*Sets the DNS address to 192.168.1.1.\*/  
:LAN:DNS? /\*The query returns the current DNS address.\*/\*

## :LAN:MAC?

**Syntax** :LAN:MAC?

**Description** Queries the MAC address of the instrument.

**Return Format** The query returns the MAC address in strings. For example, 00:19:AF:00:11:22.

## :LAN:DSErver?

**Syntax** :LAN:DSErver?

**Description** Queries the address of the DHCP server.

**Return Format** The query returns the address of the DHCP server in strings.

## :LAN:MANual

**Syntax** :LAN:MANual <bool>  
:LAN:MANual?

**Description** Turns on or off the static IP configuration mode; or queries the on/off status of the static IP configuration mode.

Parameter	Name	Type	Range	Default
	<bool>	Bool	{{1 ON} {0 OFF}}	0 OFF

**Remarks** When the static IP mode is valid, disable DHCP and Auto IP manually. You can self-define the network parameters of the oscilloscope, such as IP address, subnet mask, gateway, and DNS address. For the setting of the IP address, refer to the [:LAN:IPADdress](#) command. For the setting of the subnet mask, refer to the [:LAN:SMASk](#) command. For the setting of the gateway, refer to the [:LAN:GATeway](#) command. For the setting of DNS, refer to the [:LAN:DNS](#) command.

**Return Format** The query returns 1 or 0.

**Example** :LAN:MANual ON /\*Enables the static IP configuration mode.\*/  
:LAN:MANual? /\*The query returns 1.\*/\*

## :LAN:IPADdress

**Syntax** :LAN:IPADdress <string>

:LAN:IPADdress?

**Description** Sets or queries the IP address of the instrument.

Parameter	Name	Type	Range	Default
	<string>	ASCII String	Refer to <a href="#">Remarks</a>	---

- Remarks**
- The format of <string> is nnn,nnn,nnn,nnn. The range of the first section of "nnn" is from 0 to 223 (except 127), and the ranges of the other three sections of "nnn" are from 0 to 255.
  - When you use the command, the IP configuration mode should be static IP. Besides, the DHCP and auto IP should be disabled.

**Return Format** The query returns the current IP address in strings.

**Example** :LAN:IPADdress 192.168.1.10                    /\*Sets the IP address to 192.168.1.10.\*/  
 :LAN:IPADdress?                                        /\*The query returns the current IP address.\*/\*

## :LAN:SMASK

**Syntax** :LAN:SMASK <string>

:LAN:SMASK?

**Description** Sets or queries the subnet mask.

Parameter	Name	Type	Range	Default
	<string>	ASCII String	Refer to <a href="#">Remarks</a>	---

- Remarks**
- The format of <string> is nnn,nnn,nnn,nnn. The range of the section "nnn" is from 0 to 255.
  - When you use the command, the IP configuration mode should be static IP. The DHCP and auto IP should be disabled.

**Return Format** The query returns the current subnet mask in strings.

**Example** :LAN:SMASK 255.255.255.0                    /\*Sets the subnet mask to 255.255.255.0\*/  
 :LAN:SMASK?                                        /\*The query returns the current subnet mask.\*/\*

## :LAN:STATus?

**Syntax** :LAN:STATus?

**Description** Queries the current network configuration status.

**Return Format** The query returns UNLINK, CONNECTED, INIT, IPCONFLICT, BUSY, CONFIGURED, DHCPFAILED, INVALIDIP, or IPLOSE.

UNLINK: not connected.

CONNECTED: the network is successfully connected.

INIT: the instrument is acquiring an IP address.

IPCONFLICT: there is an IP address conflict.

BUSY: please waiting...

CONFIGURED: the network configuration has been successfully configured.

DHCPFAILED: the DHCP configuration has failed.  
 INVALIDIP: invalid IP.  
 IPLOSE: IP lost.

## :LAN:VISA?

**Syntax** :LAN:VISA?

**Description** Queries the VISA address of the instrument.

**Return Format** The query returns the VISA address in strings.

## :LAN:MDNS

**Syntax** :LAN:MDNS <bool>

:LAN:MDNS?

**Description** Enables or disables MDNS; or queries the MDNS status.

Parameter	Name	Type	Range	Default
	<bool>	Bool	{{1 ON} {0 OFF}}	0 OFF

**Return Format** The query returns 1 or 0.

**Example** :LAN:MDNS ON /\*Enables MDNS.\*/  
 :LAN:MDNS? /\*The query returns 1.\*/\*

## :LAN:HOST:NAME

**Syntax** :LAN:HOST:NAME <name>

:LAN:HOST:NAME?

**Description** Sets or queries the host name.

Parameter	Name	Type	Range	Default
	<name>	ASCII String	The name can contain English letters and numbers, as well as some symbols.	---

**Return Format** The query returns the host name in ASCII strings.

## :LAN:DESCRiption

**Syntax** :LAN:DESCRiption <name>

:LAN:DESCRiption?

**Description** Sets or queries the description.

Parameter	Name	Type	Range	Default
	<name>	ASCII String	The name can contain English letters and numbers, as well as some symbols.	---

**Return Format** The query returns the description in ASCII strings.

**:LAN:APPLY**

**Syntax** :LAN:APPLY

**Description** Applies the network configuration.



## :MASK Commands

The :MASK commands are used to set or query the relevant parameters of the pass/fail test.

### Command List:

- ◆ [:MASK:ENABle](#)
- ◆ [:MASK:SOURce](#)
- ◆ [:MASK:OPERate](#)
- ◆ [:MASK:MDISplay](#)
- ◆ [:MASK:X](#)
- ◆ [:MASK:Y](#)
- ◆ [:MASK:CREate](#)
- ◆ [:MASK:RESet](#)

### :MASK:ENABle

**Syntax** :MASK:ENABle <bool>

:MASK:ENABle?

**Description** Enables or disables the pass/fail test function; or queries the on/off status of the pass/fail test function.

Parameter	Name	Type	Range	Default
	<bool>	Bool	{{1 ON} {0 OFF}}	0 OFF

**Remarks** The pass/fail test function is invalid in the following conditions: when the horizontal time base mode is XY or ROLL; when in the slow sweep mode (i.g. the horizontal time base mode is YT, and the horizontal time base is 200 ms/div or slower); when in waveform recoding.

**Return** The query returns 1 or 0.

**Format**

**Example** :MASK:ENABle ON /\*Enables the pass/fail test function.\*  
:MASK:ENABle? /\*The query returns 1.\*

### :MASK:SOURce

**Syntax** :MASK:SOURce <source>

:MASK:SOURce?

**Description** Sets or queries the measurement source of the pass/fail test.

Parameter	Name	Type	Range	Default
	<source>	Discrete	{CHANnel1 CHANnel2 CHANnel3 CHANnel4}	CHANnel1

**Remarks** This command can only set the enabled channel, and you can send the [:CHANnel<n>:DISPlay](#) command to enable the desired channel.

**Return** The query returns CHAN1, CHAN2, CHAN3, or CHAN4.

**Format**

**Example** :MASK:SOURce CHANnel2

```
/*Sets the measurement source of the pass/fail test to CHANnel2.*/  
:MASK:SOURce?  
/*The query returns CHAN2.*/*
```

## :MASK:OPERate

**Syntax** :MASK:OPERate <oper>

:MASK:OPERate?

**Description** Runs or stops the pass/fail test; or queries the operating status of the pass/fail test.

Parameter	Name	Type	Range	Default
	<oper>	Discrete	{RUN STOP}	STOP

**Description** Before running this command, send the [:MASK:ENABLE](#) command to enable the pass/fail test function.

**Return Format** The query returns RUN or STOP.

**Example** :MASK:OPERate RUN /\*Runs the pass/fail test function.\*/  
:MASK:OPERate? /\*The query returns RUN.\*/\*

## :MASK:MDISplay

**Syntax** :MASK:MDISplay <bool>

:MASK:MDISplay?

**Description** Enables or disables the statistical function; or queries the on/off status of the statistical function when the pass/fail test is enabled.

Parameter	Name	Type	Range	Default
	<bool>	Bool	{{1 ON} {0 OFF}}	0 OFF

**Description**

- Before running this command, send the [:MASK:ENABLE](#) command to enable the pass/fail test function.
- When the statistics is enabled, the following test results are displayed on the screen, as shown in the figure below.



**Return Format** The query returns 1 or 0.

**Example** :MASK:MDISplay ON /\*Enables the statistics.\*/  
:MASK:MDISplay? /\*The query returns 1.\*/\*

**:MASK:X****Syntax** :MASK:X <x>

:MASK:X?

**Description** Sets or queries the horizontal adjustment parameter of the pass/fail test mask. The default unit is div.

Parameter	Name	Type	Range	Default
	<x>	Real	0.01 div to 2 div	0.24 div

**Return Format** The query returns the current horizontal adjustment parameter in scientific notation.

**Example** :MASK:X 0.28 /\*Sets the horizontal adjustment parameter to 0.28 div.\*/  
 :MASK:X? /\*The query returns 2.800000E-1.\*/

**:MASK:Y****Syntax** :MASK:Y <y>

:MASK:Y?

**Description** Sets or queries the vertical adjustment parameter of the pass/fail test mask. The default unit is div.

Parameter	Name	Type	Range	Default
	<y>	Real	0.04 div to 2 div	0.48 div

**Return Format** The query returns the current vertical adjustment parameter in scientific notation.

**Example** :MASK:Y 0.36 /\*Sets the vertical adjustment parameter to 0.36 div.\*/  
 :MASK:Y? /\*The query returns 3.600000E-1.\*/

**:MASK:CREate****Syntax** :MASK:CREate**Description** Creates the pass/fail test mask with the currently set horizontal and vertical adjustment parameters.**Description** This command is only valid when the pass/fail test function is enabled and not in running state.**:MASK:RESet****Syntax** :MASK:RESet**Description** Resets the number of frames that passed and failed the pass/fail test, as well as the total number of frames.

## :MATH<n> Commands

The :MATH<n> commands are used to set various math operation functions of the waveform between channels.

### Note:

- The math operations include the following types:  
 arithmetic operations:  $A+B$ ,  $A-B$ ,  $A\times B$ ,  $A/B$   
 spectrum operation: FFT  
 Logic operation:  $A\&\&B$ ,  $A||B$ ,  $A^B$ ,  $!A$   
 function operation: Intg, Diff, Sqrt, Lg, Ln, Exp, Abs,  $AX+B$   
 digital filter: Low Pass Filter, High Pass Filter, Band Pass Filter, Band Stop Filter
- For the logic operation, the waveform data involved in the operation and the preset threshold are compared with each other, and then transferred to 0 or 1. Therefore, the operation results are only reduced to 0 and 1.

### Command List:

- ◆ [:MATH<n>:DISPlay](#)
- ◆ [:MATH<n>:OPERator](#)
- ◆ [:MATH<n>:SOURce1](#)
- ◆ [:MATH<n>:SOURce2](#)
- ◆ [:MATH<n>:LSOURce1](#)
- ◆ [:MATH<n>:LSOURce2](#)
- ◆ [:MATH<n>:SCALe](#)
- ◆ [:MATH<n>:OFFSet](#)
- ◆ [:MATH<n>:INVert](#)
- ◆ [:MATH<n>:RESet](#)
- ◆ [:MATH<n>:FFT:SOURce](#)
- ◆ [:MATH<n>:FFT:WINDow](#)
- ◆ [:MATH<n>:FFT:UNIT](#)
- ◆ [:MATH<n>:FFT:SCALe](#)
- ◆ [:MATH<n>:FFT:OFFSet](#)
- ◆ [:MATH<n>:FFT:HSCale](#)
- ◆ [:MATH<n>:FFT:HCENter](#)
- ◆ [:MATH<n>:FFT:FREQuency:STARt](#)
- ◆ [:MATH<n>:FFT:FREQuency:END](#)
- ◆ [:MATH<n>:FFT:SEARch:ENABLE](#)
- ◆ [:MATH<n>:FFT:SEARch:NUM](#)
- ◆ [:MATH<n>:FFT:SEARch:THReshold](#)
- ◆ [:MATH<n>:FFT:SEARch:EXCURsion](#)
- ◆ [:MATH<n>:FFT:SEARch:ORDer](#)
- ◆ [:MATH<n>:FILTer:TYPE](#)

- ◆ [:MATH<n>:FILTer:W1](#)
- ◆ [:MATH<n>:FILTer:W2](#)
- ◆ [:MATH<n>:SENSitivity](#)
- ◆ [:MATH<n>:DISTance](#)
- ◆ [:MATH<n>:THReshold1](#)
- ◆ [:MATH<n>:THReshold2](#)
- ◆ [:MATH<n>:THReshold3](#)
- ◆ [:MATH<n>:THReshold4](#)

## :MATH<n>:DISPlay

**Syntax** :MATH<n>:DISPlay <bool>

:MATH<n>:DISPlay?

**Description** Enables or disables the math operation function; or queries the status of the math operation function.

Parameter	Name	Type	Range	Default
	<n>	Discrete	{1 2 3 4}	---
	<bool>	Bool	{{1 ON}} {0 OFF}}	0 OFF

**Return Format** The query returns 1 or 0.

**Example** :MATH1:DISPlay ON /\*Enables the operation function of Math1.\*/  
:MATH1:DISPlay? /\*The query returns 1.\*/

## :MATH<n>:OPERator

**Syntax** :MATH<n>:OPERator <opt>

:MATH<n>:OPERator?

**Description** Sets or queries the operator of math operation.

Parameter	Name	Type	Range	Default
	<n>	Discrete	{1 2 3 4}	---
	<opt>	Discrete	{ADD SUBTract MULTiply DIVision AND OR XOR NOT FFT INTG DIFF SQRT LOG LN EXP ABS LPASs HPASs BPASs BSTop AXB}	ADD

**Return Format** The query returns ADD, SUBT, MULT, DIV, AND, OR, XOR, NOT, FFT, INTG, DIFF, SQRT, LOG, LN, EXP, ABS, LPAS, HPAS, BPAS, BST, or AXB.

**Example** :MATH1:OPERator INTG /\*Sets the math operator of Math1 to Integrate.\*/  
:MATH1:OPERator? /\*The query returns INTG.\*/

**:MATH<n>:SOURce1**

**Syntax** :MATH<n>:SOURce1 <src>

:MATH<n>:SOURce1?

**Description** Sets or queries the source or Source A of arithmetic operation and function operation.

Parameter	Name	Type	Range	Default
	<n>	Discrete	{1 2 3 4}	---
	<src>	Discrete	{CHANnel1 CHANnel2 CHANnel3 CHANnel4}	CHANnel1

- Remarks**
- For arithmetic operation, this command is used to set Source A.
  - For function operation, use this command only to set the source.

**Return Format** The query returns CHAN1, CHAN2, CHAN3, or CHAN4.

**Example** :MATH1:SOURce1 CHANnel3 /\*Sets Source A of the arithmetic operation to CH3.\*/  
:MATH1:SOURce1? /\*The query returns CHAN3.\*/\*

**:MATH<n>:SOURce2**

**Syntax** :MATH<n>:SOURce2 <src>

:MATH<n>:SOURce2?

**Description** Sets or queries Source B of arithmetic operation.

Parameter	Name	Type	Range	Default
	<n>	Discrete	{1 2 3 4}	---
	<src>	Discrete	{CHANnel1 CHANnel2 CHANnel3 CHANnel4}	CHANnel1

**Remarks** This command is only available for arithmetic operation (containing two sources).

**Return Format** The query returns CHAN1, CHAN2, CHAN3, or CHAN4.

**Example** :MATH1:SOURce2 CHANnel3 /\*Sets Source B of the arithmetic operation to CH3.\*/  
:MATH1:SOURce2? /\*The query returns CHAN3.\*/\*

**:MATH<n>:LSOURce1**

**Syntax** :MATH<n>:LSOURce1 <src>

:MATH<n>:LSOURce1?

**Description** Sets or queries Source A of the logic operation.

Parameter	Name	Type	Range	Default
	<n>	Discrete	{1 2 3 4}	---
	<src>	Discrete	{D0 D1 D2 D3 D4 D5 D6 D7 D8  D9 D10 D11 D12 D13 D14 D15  CHANnel1 CHANnel2 CHANnel3 CHANnel4}	CHANnel1

**Remarks** The logic operations include A&&B, A||B, A^B, and !A.

**Return Format** The query returns D0, D1, D2, D3, D4, D5, D6, D7, D8, D9, D10, D11, D12, D13, D14, D15, CHAN1, CHAN2, CHAN3, or CHAN4.

**Example** :MATH1:LSOURce1 D3 /\*Sets Source A of the logic operation to D3.\*/  
 :MATH1:LSOURce1? /\*The query returns D3.\*/

## :MATH<n>:LSOURce2

**Syntax** :MATH<n>:LSOURce2 <src>  
 :MATH<n>:LSOURce2?

**Description** Sets or queries Source B of the logic operation.

Parameter	Name	Type	Range	Default
	<n>	Discrete	{1 2 3 4}	---
	<src>	Discrete	{D0 D1 D2 D3 D4 D5 D6 D7 D8 D9 D10 D11 D12 D13 D14 D15 CHANnel1 CHANnel2 CHANnel3 CHANnel4}	CHANnel1

**Remarks**

- The logic operations include A&&B, A||B, A^B, and !A.
- This command is only available for the logic operation that contains two sources. It is used to set Source B.

**Return Format** The query returns D0, D1, D2, D3, D4, D5, D6, D7, D8, D9, D10, D11, D12, D13, D14, D15, CHAN1, CHAN2, CHAN3, or CHAN4.

**Example** :MATH1:LSOURce2 D4 /\*Sets Source B of the logic operation to D4.\*/  
 :MATH1:LSOURce2? /\*The query returns D4.\*/

## :MATH<n>:SCALE

**Syntax** :MATH<n>:SCALE <scale>  
 :MATH<n>:SCALE?

**Description** Sets or queries the vertical scale of the operation results. The unit is related to the currently selected operator and the unit selected by the source.

Parameter	Name	Type	Range	Default
	<n>	Discrete	{1 2 3 4}	---
	<scale>	Real	Refer to <a href="#">Remarks</a>	---

**Remarks** The setting range of vertical scale is related to the currently selected operator and the scale of the source channel. For integration and differentiation operations, the actual range of <scale> is also related to the current horizontal time base.

**Return Format** The query returns the vertical scale of the current operation results in scientific notation.

**Example** :MATH1:SCALE 0.2 /\*Sets the vertical scale to 200 mV.\*/  
 :MATH1:SCALE? /\*The query returns 2.000000E-1.\*/

**:MATH<n>:OFFSet**

**Syntax** :MATH<n>:OFFSet <offset>

:MATH<n>:OFFSet?

**Description** Sets or queries the vertical offset of the operation results. The unit is related to the currently selected operator and the unit selected by the source.

Parameter	Name	Type	Range	Default
	<n>	Discrete	{1 2 3 4}	---
	<offset>	Real	-1 GV to +1 GV	0.00 V

**Return Format** The query returns the vertical offset of the current operation results in scientific notation.

**Example** :MATH1:OFFSet 8 /\*Sets the vertical offset to 8 V.\*/  
:MATH1:OFFSet? /\*The query returns 8.000000E0.\*/

**:MATH<n>:INVert**

**Syntax** :MATH<n>:INVert <bool>

:MATH<n>:INVert?

**Description** Enables or disables the inverted display of the operation results; or queries the status of the inverted display of the operation results.

Parameter	Name	Type	Range	Default
	<n>	Discrete	{1 2 3 4}	---
	<bool>	Bool	{{1 ON} {0 OFF}}	0 OFF

**Remarks** This command is invalid for FFT operation.

**Return Format** The query returns 1 or 0.

**Example** :MATH1:INVert ON /\*Enables the inverted display.\*/  
:MATH1:INVert? /\*The query returns 1.\*/

**:MATH<n>:RESet**

**Syntax** :MATH<n>:RESet

**Description** After you send this command, the instrument will adjust the vertical scale of the operation results to an optimal value based on the currently selected operator and the horizontal time base of the source.



**:MATH<n>:FFT:SOURce**

**Syntax** :MATH<n>:FFT:SOURce <src>

:MATH<n>:FFT:SOURce?

**Description** Sets or queries the channel source of FFT operation/filter.

Parameter	Name	Type	Range	Default
	<n>	Discrete	{1 2 3 4}	---
	<src>	Discrete	{CHANnel1 CHANnel2 CHANnel3 CHANnel4}	CHANnel1

**Return Format** The query returns CHAN1, CHAN2, CHAN3, or CHAN4.

**Example** :MATH1:FFT:SOURce CHANnel3 /\*Sets the channel source of FFT operation to CH3.\*/  
:MATH1:FFT:SOURce? /\*The query returns CHAN3.\*/

**:MATH<n>:FFT:WINDow**

**Syntax** :MATH<n>:FFT:WINDow <wnd>

:MATH<n>:FFT:WINDow?

**Description** Sets or queries the window function of FFT operation.

Parameter	Name	Type	Range	Default
	<n>	Discrete	{1 2 3 4}	---
	<wnd>	Discrete	{RECTangle BLACkman HANNing HAMMing FLATtop TRIangle}	RECTangle

- Remarks**
- Spectral leakage can be considerably decreased when a window function is used.
  - Different window functions are applicable to measurements of different waveforms. You need to select the window function according to the different waveforms to be measured and their characteristics.

**Return Format** The query returns RECT, BLAC, HANN, HAMM, FLAT, or TRI.

**Example** :MATH1:FFT:WINDow BLACkman /\*Sets the window function of FFT operation to Blackman-Harris.\*/  
:MATH1:FFT:WINDow? /\*The query returns BLAC.\*/

**:MATH<n>:FFT:UNIT**

**Syntax** :MATH<n>:FFT:UNIT <unit>

:MATH<n>:FFT:UNIT?

**Description** Sets or queries the vertical unit of FFT operation results.

Parameter	Name	Type	Range	Default
	<n>	Discrete	{1 2 3 4}	---
	<unit>	Discrete	{VRMS DB}	DB

**Return Format** The query returns VRMS or DB.

**Example** :MATH1:FFT:UNIT VRMS /\*Sets the vertical unit of FFT operation results to Vrms.\*/  
 :MATH1:FFT:UNIT? /\*The query returns VRMS.\*/

## :MATH<n>:FFT:SCALE

**Syntax** :MATH<n>:FFT:SCALE <scale>

:MATH<n>:FFT:SCALE?

**Description** Sets or queries the vertical scale of FFT operation results.

Parameter	Name	Type	Range	Default
	<n>	Discrete	{1 2 3 4}	---
	<scale>	Real	1 ndB to 5 GdB	1 dB

**Return Format** The query returns the current vertical scale in scientific notation.

**Example** :MATH1:FFT:SCALE 0.3 /\*Sets the vertical scale of the FFT operation results to 300 mdB.\*/

:MATH1:FFT:SCALE? /\*The query returns 3.000000E-1.\*/

## :MATH<n>:FFT:OFFSet

**Syntax** :MATH<n>:FFT:OFFSet <offset>

:MATH<n>:FFT:OFFSet?

**Description** Sets or queries the vertical offset of FFT operation results.

Parameter	Name	Type	Range	Default
	<n>	Discrete	{1 2 3 4}	---
	<offset>	Real	-1 GdB to 1 GdB	0 dB

**Return Format** The query returns the current vertical offset in scientific notation.

**Example** :MATH1:FFT:OFFSet 0.3 /\*Sets the vertical offset of the FFT operation results to 300 mdB\*/

:MATH1:FFT:OFFSet? /\*The query returns 3.000000E-1.\*/

## :MATH<n>:FFT:HSCale

**Syntax** :MATH<n>:FFT:HSCale <hsc>

:MATH<n>:FFT:HSCale?

**Description** Sets or queries the frequency range of FFT operation results. The default unit is Hz.

Parameter	Name	Type	Range	Default
	<hsc>	Real	10 Hz to 5 GHz	10 MHz

**Remarks** You can reduce the frequency range to observe the details of the spectrum.

**Return Format** The query returns the current frequency range in scientific notation.

**Example** :MATH1:FFT:HSCale 500000 /\*Sets the frequency range of FFT operation results to 500 kHz.\*/  
 :MATH1:FFT:HSCale? /\*The query returns 5.000000E+5.\*/

## :MATH<n>:FFT:HCENter

**Syntax** :MATH<n>:FFT:HCENter <cent>  
 :MATH<n>:FFT:HCENter?

**Description** Sets or queries the center frequency of FFT operation results, i.g. the frequency relative to the horizontal center of the screen. The default unit is Hz.

Parameter	Name	Type	Range	Default
	<n>	Discrete	{1 2 3 4}	---
	<cent>	Real	-2.5 GHz to 2.5 GHz	5 MHz

**Return Format** The query returns the current center frequency in scientific notation.

**Example** :MATH1:FFT:HCENter 10000000 /\*Sets the center frequency of the FFT operation results to 10 MHz.\*/  
 :MATH1:FFT:HCENter? /\*The query returns 1.000000E+7.\*/

## :MATH<n>:FFT:FREQuency:START

**Syntax** :MATH<n>:FFT:FREQuency:START <value>  
 :MATH<n>:FFT:FREQuency:START?

**Description** Sets or queries the start frequency of FFT operation results.

Parameter	Name	Type	Range	Default
	<n>	Discrete	{1 2 3 4}	---
	<value>	Real	-2.5 GHz to 2.5 GHz	0 Hz

**Return Format** The query returns the start frequency of the operation results in scientific notation.

**Example** :MATH1:FFT:FREQuency:START 10000000 /\*Sets the start frequency of the FFT operation results to 10 MHz.\*/  
 :MATH1:FFT:FREQuency:START? /\*The query returns 1.000000E+7.\*/

## :MATH<n>:FFT:FREQuency:END

**Syntax** :MATH<n>:FFT:FREQuency:END <value>  
 :MATH<n>:FFT:FREQuency:END?

**Description** Sets or queries the stop frequency of FFT operation results.

Parameter	Name	Type	Range	Default
	<n>	Discrete	{1 2 3 4}	---
	<value>	Real	-2.5 GHz to 2.5 GHz	10 MHz

**Return Format** The query returns the stop frequency of the operation results in scientific notation.

**Example** :MATH1:FFT:FREQuency:END 10000000 /\*Sets the stop frequency of the FFT operation results to 10 MHz.\*/  
:MATH1:FFT:FREQuency:END? /\*The query returns 1.000000E+7.\*/

## :MATH<n>:FFT:SEARch:ENABLE

**Syntax** :MATH<n>:FFT:SEARch:ENABLE <bool>  
:MATH<n>:FFT:SEARch:ENABLE?

**Description** Enables or disables the FFT peak search; or queries the on/off status of the FFT peak search function.

Parameter	Name	Type	Range	Default
	<n>	Discrete	{1 2 3 4}	---
	<bool>	Bool	{{1 ON}} {0 OFF}}	0 OFF

**Return Format** The query returns 1 or 0.

**Example** :MATH1:FFT:SEARch:ENABLE ON /\*Enables the FFT peak search.\*/  
:MATH1:FFT:SEARch:ENABLE? /\*The query returns 1.\*/

## :MATH<n>:FFT:SEARch:NUM

**Syntax** :MATH<n>:FFT:SEARch:NUM <num>  
:MATH<n>:FFT:SEARch:NUM?

**Description** Sets or queries the maximum number of the FFT peak search.

Parameter	Name	Type	Range	Default
	<n>	Discrete	{1 2 3 4}	---
	<num>	Integer	1 to 15	5

**Return Format** The query returns an integer ranging from 1 to 15.

**Example** :MATH1:FFT:SEARch:NUM 10 /\*Sets the maximum number of the FFT peak search to 10.\*/  
:MATH1:FFT:SEARch:NUM? /\*The query returns 10.\*/

## :MATH<n>:FFT:SEARch:THReshold

**Syntax** :MATH<n>:FFT:SEARch:THReshold <thres>  
:MATH<n>:FFT:SEARch:THReshold?

**Description** Sets or queries the threshold of the FFT peak search.

Parameter	Name	Type	Range	Default
	<n>	Discrete	{1 2 3 4}	---
	<thres>	Real	Related to the vertical scale and vertical offset of FFT operation	5.5 dB

**Return Format** The query returns the threshold in scientific notation.

**Example** :MATH1:FFT:SEARch:THReshold 0.5 /\*Sets the threshold of the FFT peak search to 500 mdB.\*/  
:MATH1:FFT:SEARch:THReshold? /\*The query returns 5.000000E-1.\*/

## :MATH<n>:FFT:SEARch:EXCursion

**Syntax** :MATH<n>:FFT:SEARch:EXCursion <excur>  
:MATH<n>:FFT:SEARch:EXCursion?

**Description** Sets or queries the excursion of the FFT peak search.

Parameter	Name	Type	Range	Default
	<n>	Discrete	{1 2 3 4}	---
	<excur>	Real	0 to (8xVerticalScale)	1.8 dB

**Remarks** VerticalScale indicates the vertical scale of the current source.

**Return Format** The query returns the excursion of the FFT peak search in scientific notation.

**Example** :MATH1:FFT:SEARch:EXCursion 0.5 /\*Sets the excursion of the FFT peak search to 500 mdB.\*/  
:MATH1:FFT:SEARch:EXCursion? /\*The query returns 5.000000E-1.\*/

## :MATH<n>:FFT:SEARch:ORDer

**Syntax** :MATH<n>:FFT:SEARch:ORDer <order>  
:MATH<n>:FFT:SEARch:ORDer?

**Description** Sets or queries the sequence of the FFT peak search results.

Parameter	Name	Type	Range	Default
	<n>	Discrete	{1 2 3 4}	---
	<order>	Discrete	{AMPorder FREQorder}	AMPorder

**Return Format** The query returns AMP or FREQ.

**Example** :MATH1:FFT:SEARch:ORDer AMPorder /\*Sets the sequence of the FFT peak search results to AMPorder.\*/  
:MATH1:FFT:SEARch:ORDer? /\*The query returns AMP.\*/

## :MATH<n>:FILTer:TYPE

**Syntax** :MATH<n>:FILTer:TYPE <type>  
:MATH<n>:FILTer:TYPE?

**Description** Sets or queries the filter type.

Parameter	Name	Type	Range	Default
	<n>	Discrete	{1 2 3 4}	---
	<type>	Discrete	{LPASs HPASs BPASs BStop}	LPASs

- Remarks**
- MSO8000 provides 4 practical filters (Low Pass Filter, High Pass Filter, Band Pass Filter, and Band Stop Filter), which can filter the specified frequencies in the signal by setting the bandwidth. You can use the `:MATH<n>:FFT:SOURce` command to set or query the channel source of the filter.
  - LPASs: indicates low pass filter, which only allows the signals whose frequencies are smaller than the current cut-off frequency to pass.
  - HPASs: indicates high pass filter, which only allows the signals whose frequencies are greater than the current cut-off frequency to pass.
  - BPASs: indicates band pass filter, which only allows the signals whose frequencies are greater than the current cut-off frequency 1 and smaller than the current cut-off frequency 2 to pass.  
**Note:** The cut-off frequency 1 must be smaller than the cut-off frequency 2.
  - BSTop: indicates band stop filter, which only allows the signals whose frequencies are smaller than the current cut-off frequency 1 or greater than the current cut-off frequency 2 to pass.  
**Note:** The cut-off frequency 1 must be smaller than the cut-off frequency 2.

**Return Format** The query returns LPAS, HPAS, BPAS, or BST.

**Example** `:MATH1:FILTer:TYPE LPASs /*Sets the filter type to LPASs.*/  
:MATH1:FILTer:TYPE? /*The query returns LPAS.*/*`

## :MATH<n>:FILTer:W1

**Syntax** `:MATH<n>:FILTer:W1 <freq1>  
:MATH<n>:FILTer:W1?`

**Description** Sets or queries the cut-off frequency of Low Pass Filter/High Pass Filter; or the cut-off frequency 1 of Band Pass Filter/Band Stop Filter. The default unit is Hz.

Parameter	Name	Type	Range	Default
	<n>	Discrete	{1 2 3 4}	---
	<freq1>	Real	Refer to <a href="#">Remarks</a>	Related to the filter type LPASs BPASs BSTop: 0.005×screen sample rate HPASs: 0.1×screen sample rate

- Remarks**
- When the filter type is set to LPASs (Low Pass Filter) or HPASs (High Pass Filter), you need to set one cut-off frequency. At this time, the range of <freq1> is from (0.005×screen sample rate) to (0.1×screen sample rate), at a step of (0.005×screen sample rate). Wherein, screen sample rate = 100/horizontal time base.
  - When the filter type is set to BPASs (Band Pass Filter) or BSTop (Band Stop Filter), you need to set two cut-off frequencies. Run this command to set the cut-off frequency 1, and run the `:MATH<n>:FILTer:W2` command to set the cut-off frequency 2. At this time, the range of <freq1> is from (0.005×screen sample rate) to (0.095×screen sample rate), at a step of (0.005×screen sample rate). Wherein, screen sample rate = 100/horizontal time base.  
**Note:** The cut-off frequency 1 must be smaller than the cut-off frequency 2.

**Return Format** The query returns the current cut-off frequency or cut-off frequency 1 in scientific notation.

**Example** `:MATH1:FILTer:W1 1000000 /*Sets the cut-off frequency of Low Pass Filter to 1 MHz.*/  
:MATH1:FILTer:W1? /*The query returns 1.000000E+6.*/*`

**:MATH<n>:FILTer:W2****Syntax** :MATH<n>:FILTer:W2 <freq2>

:MATH&lt;n&gt;:FILTer:W2?

**Description** Sets or queries the cut-off frequency 2 of Band Pass Filter/Band Stop Filter. The default unit is Hz.

Parameter	Name	Type	Range	Default
	<n>	Discrete	{1 2 3 4}	---
	<freq2>	Real	Refer to <a href="#">Remarks</a>	0.1×screen sample rate

**Remarks** When the filter type is set to BPASs (Band Pass Filter) or BSTop (Band Stop Filter), you need to set two cut-off frequencies. Run the [:MATH<n>:FILTer:W1](#) command to set the cut-off frequency 1, and run this command to set the cut-off frequency 2. At this time, the range of <freq2> is from (0.01×screen sample rate) to (0.1×screen sample rate), at a step of (0.005×screen sample rate). Wherein, screen sample rate = 100/horizontal time base

**Note:** The cut-off frequency 2 must be greater than the cut-off frequency 1.**Return Format** The query returns the current cut-off frequency 2 in scientific notation.

**Example** :MATH1:FILTer:W2 1500000 /\*Sets the cut-off frequency 2 of Band Pass Filter to 1.5 MHz.\*/

:MATH1:FILTer:W2? /\*The query returns 1.500000E+6.\*/

**:MATH<n>:SENSitivity****Syntax** :MATH<n>:SENSitivity <sens>

:MATH&lt;n&gt;:SENSitivity?

**Description** Sets or queries the sensitivity of the logic operation. The default unit is div.

Parameter	Name	Type	Range	Default
	<n>	Discrete	{1 2 3 4}	---
	<sens>	Real	100 mdiv to 1 div	300 mdiv

**Return Format** The query returns the sensitivity of the logic operation in scientific notation.

**Example** :MATH1:SENSitivity 0.2 /\*Sets the sensitivity of the logic operation to 0.2 div.\*/

:MATH1:SENSitivity? /\*The query returns 2.400000E-1.\*/

**:MATH<n>:DISTance****Syntax** :MATH<n>:DISTance <dist>

:MATH&lt;n&gt;:DISTance?

**Description** Sets or queries the smoothing window width of differential operation.

Parameter	Name	Type	Range	Default
	<n>	Discrete	{1 2 3 4}	---
	<dist>	Integer	5 to 10000	5

**Return Format** The query returns an integer ranging from 5 to 10000.

**Example** :MATH1:DIStance 20 /\*Sets the smoothing window width of differential operation to 20.\*/  
:MATH1:DIStance? /\*The query returns 20.\*/

## :MATH<n>:THReshold1

**Syntax** :MATH<n>:THReshold1 <thre>  
:MATH<n>:THReshold1?

**Description** Sets or queries threshold level of Analog Channel 1 in the logic operation. The default unit is V.

Parameter	Name	Type	Range	Default
	<n>	Discrete	{1 2 3 4}	---
	<thre>	Real	(-4 × VerticalScale - VerticalOffset) to (4 × VerticalScale - VerticalOffset)	0 V

**Description**

- This command is only available for the logic operations A&&B, A||B, A^B, and !A.
- VerticalScale indicates the vertical scale of Analog Channel 1.  
VerticalOffset indicates the vertical offset of Analog Channel 1.  
The step value is VerticalScale/10.

**Return Format** The query returns the threshold level of Analog Channel 1 in scientific notation.

**Example** :MATH1:THReshold1 0.8 /\*Sets the threshold level of Analog Channel 1 in logic operation to 800 mV.\*/  
:MATH1:THReshold1? /\*The query returns 8.000000E-1.\*/

## :MATH<n>:THReshold2

**Syntax** :MATH<n>:THReshold2 <thre>  
:MATH<n>:THReshold2?

**Description** Sets or queries threshold level of Analog Channel 2 in the logic operation. The default unit is V.

Parameter	Name	Type	Range	Default
	<n>	Discrete	{1 2 3 4}	---
	<thre>	Real	(-4 × VerticalScale - VerticalOffset) to (4 × VerticalScale - VerticalOffset)	0 V

**Description**

- This command is only available for the logic operations A&&B, A||B, A^B, and !A.
- VerticalScale indicates the vertical scale of Analog Channel 2.  
VerticalOffset indicates the vertical offset of Analog Channel 2.  
The step value is VerticalScale/10.

**Return Format** The query returns the threshold level of Analog Channel 2 in scientific notation.

**Example** :MATH1:THReshold2 0.8 /\*Sets the threshold level of Analog Channel 2 in logic operation to 800 mV.\*/  
:MATH1:THReshold2? /\*The query returns 8.000000E-1.\*/



**:MATH<n>:THReshold3**

**Syntax** :MATH<n>:THReshold3 <thre>

:MATH<n>:THReshold3?

**Description** Sets or queries threshold level of Analog Channel 3 in the logic operation. The default unit is V.

Parameter	Name	Type	Range	Default
	<n>	Discrete	{1 2 3 4}	---
	<thre>	Real	(-4 × VerticalScale - VerticalOffset) to (4 × VerticalScale - VerticalOffset)	0 V

**Description**

- This command is only available for the logic operations A&&B, A||B, A^B, and !A.
- VerticalScale indicates the vertical scale of Analog Channel 3. VerticalOffset indicates the vertical offset of Analog Channel 3. The step value is VerticalScale/10.

**Return Format** The query returns the threshold level of Analog Channel 3 in scientific notation.

**Example** :MATH1:THReshold3 0.8 /\*Sets the threshold level of Analog Channel 3 in logic operation to 800 mV.\*/  
:MATH1:THReshold3? /\*The query returns 8.000000E-1.\*/\*

**:MATH<n>:THReshold4**

**Syntax** :MATH<n>:THReshold4 <thre>

:MATH<n>:THReshold4?

**Description** Sets or queries threshold level of Analog Channel 4 in the logic operation. The default unit is V.

Parameter	Name	Type	Range	Default
	<n>	Discrete	{1 2 3 4}	---
	<thre>	Real	(-4 × VerticalScale - VerticalOffset) to (4 × VerticalScale - VerticalOffset)	0 V

**Description**

- This command is only available for the logic operations A&&B, A||B, A^B, and !A.
- VerticalScale indicates the vertical scale of Analog Channel 4. VerticalOffset indicates the vertical offset of Analog Channel 4. The step value is VerticalScale/10.

**Return Format** The query returns the threshold level of Analog Channel 4 in scientific notation.

**Example** :MATH1:THReshold2 0.8 /\*Sets the threshold level of Analog Channel 4 in logic operation to 800 mV.\*/  
:MATH1:THReshold2? /\*The query returns 8.000000E-1.\*/\*

## :MEASure Commands

The :MEASure commands are used to set and query the relevant parameters for measurement.

### Command List:

- ◆ [:MEASure:SOURce](#)
- ◆ [:MEASure:COUNter:ENABle](#)
- ◆ [:MEASure:COUNter:SOURce](#)
- ◆ [:MEASure:COUNter:VALue?](#)
- ◆ [:MEASure:CLEAr](#)
- ◆ [:MEASure:THReshold:SOURce](#)
- ◆ [:MEASure:THReshold:DEFault](#)
- ◆ [:MEASure:MODE](#)
- ◆ [:MEASure:AMSource](#)
- ◆ [:MEASure:SETup:MAX](#)
- ◆ [:MEASure:SETup:MID](#)
- ◆ [:MEASure:SETup:MIN](#)
- ◆ [:MEASure:SETup:PSA](#)
- ◆ [:MEASure:SETup:PSB](#)
- ◆ [:MEASure:SETup:DSA](#)
- ◆ [:MEASure:SETup:DSB](#)
- ◆ [:MEASure:STATistic:DISPlay](#)
- ◆ [:MEASure:STATistic:RESet](#)
- ◆ [:MEASure:STATistic:ITEM](#)
- ◆ [:MEASure:ITEM](#)
- ◆ [:MEASure:AREA](#)
- ◆ [:MEASure:CREGion:CAX](#)
- ◆ [:MEASure:CREGion:CBX](#)
- ◆ [:MEASure:CATegory](#)

## :MEASure:SOURce

**Syntax** :MEASure:SOURce <sour>

:MEASure:SOURce?

**Description** Sets or queries the channel source of the current measurement parameter.

Parameter	Name	Type	Range	Default
	<sour>	Discrete	{D0 D1 D2 D3 D4 D5 D6 D7 D8  D9 D10 D11 D12 D13 D14 D15  CHANnel1 CHANnel2 CHANnel3 CHANnel4  MATH1 MATH2 MATH3 MATH4}	CHANnel1

**Remarks** Only the currently enabled channels can be selected.

**Return Format** The query returns D0, D1, D2, D3, D4, D5, D6, D7, D8, D9, D10, D11, D12, D13, D14, D15, CHAN1, CHAN2, CHAN3, CHAN4, MATH1, MATH2, MATH3, or MATH4.

**Example** :MEASure:SOURce CHANnel2  
 /\*Sets the channel source for the parameter to CHANnel2.\*/  
 :MEASure:SOURce?  
 /\*The query returns CHAN2.\*/\*

## :MEASure:COUNTER:ENABLE

**Syntax** :MEASure:COUNTER:ENABLE <bool>  
 :MEASure:COUNTER:ENABLE?

**Description** Enables or disables the frequency counter; or queries the on/off status of the frequency counter.

Parameter	Name	Type	Range	Default
	<bool>	Bool	{{1 ON}} {{0 OFF}}	0 OFF

**Return Format** The query returns 1 or 0.

**Example** :MEASure:COUNTER:ENABLE ON /\*Enables the frequency counter.\*/  
 :MEASure:COUNTER:ENABLE? /\*The query returns 1.\*/\*

## :MEASure:COUNTER:SOURce

**Syntax** :MEASure:COUNTER:SOURce <source>  
 :MEASure:COUNTER:SOURce?

**Description** Sets or queries the measurement source of the frequency counter.

Parameter	Name	Type	Range	Default
	<source>	Discrete	{D0 D1 D2 D3 D4 D5 D6 D7 D8 D9 D10 D11 D12 D13 D14 D15 CHANnel1 CHANnel2 CHANnel3 CHANnel4 EXT}	CHANnel1

**Remarks** Only the currently enabled channels can be selected.

**Return Format** The query returns D0, D1, D2, D3, D4, D5, D6, D7, D8, D9, D10, D11, D12, D13, D14, D15, CHAN1, CHAN2, CHAN3, CHAN4, or EXT.

**Example** :MEASure:COUNTER:SOURce CHANnel2 /\*Sets the measurement source for the frequency counter to CHANnel2.\*/  
 :MEASure:COUNTER:SOURce? /\*The query returns CHAN2.\*/\*

**:MEASure:COUNTER:VALue?**

**Syntax** :MEASure:COUNTER:VALue?

**Description** Queries the measurement results of the frequency counter. The default unit is Hz.

**Return Format** The query returns the current measurement value in scientific notation. If the frequency counter function is currently disabled, the query returns 0.

**Example** :MEASure:COUNTER:VALue? /\*The query returns 1000.\*/

**:MEASure:CLEar**

**Syntax** :MEASure:CLEar <item>

**Description** Clears any one or all of the 10 measurement items that have been turned on last time.

Parameter	Name	Type	Range	Default
<item>		Discrete	{ITEM1 ITEM2 ITEM3 ITEM4 ITEM5 ITEM6 ITEM7 ITEM8 ITEM9 ITEM10 ALL}	---

**Remarks** Run the [:MEASure:ITEM](#) command to open one of the 41 parameters that is required to be measured. The 10 measurement items turned on last time are determined by the order in which you turned them on, and they will not be affected if you delete one or multiple measurement items.

**Example** :MEASure:CLEar ITEM1 /\*Clears a measurement item ITEM1.\*/

**:MEASure:THReshold:SOURce**

**Syntax** :MEASure:THReshold:SOURce <source>

**Description** Sets the threshold source.

Parameter	Name	Type	Range	Default
<source>		Discrete	{CHANnel1 CHANnel2 CHANnel3 CHANnel4 MATH1 MATH2 MATH3 MATH4}	CHANnel1

**Remarks** Modifying the threshold will affect the measurement results of time, delay, and phase parameters.

**Example** :MEASure:THReshold:SOURce CHANnel2 /\*Sets the threshold source to CHANnel2.\*/

**:MEASure:THReshold:DEFault**

**Syntax** :MEASure:THReshold:DEFault

**Description** Sets the threshold level of the analog channel in auto measurement to a default value.

**:MEASure:MODE**

**Syntax** :MEASure:MODE <mode>

:MEASure:MODE?

**Description** Sets or queries the measurement mode.

Parameter	Name	Type	Range	Default
<mode>		Discrete	{NORMal PRECision}	NORMal

- Remarks**
- NORMal: executes measurement of up to 1 Mpts.
  - PRECision: executes measurement of up to 500 Mpts, improving the resolution of measurement results. Note, in this mode, the refresh rate of the waveforms may be reduced.

**Example** The query returns NORM or PREC.

```
:MEASure:MODE PRECision      /*Sets the measurement mode to PRECision.*/  
:MEASure:MODE?              /*The query returns PREC.*/
```

## :MEASure:AMSource

**Syntax** :MEASure:AMSource <chan>

:MEASure:AMSource?

**Description** Sets the source and displays all measurement values of the set source; or queries the channel source(s) of the all measurement function.

Parameter	Name	Type	Range	Default
	<chan>	Discrete	{CHANnel1 CHANnel2 CHANnel3 CHANnel4 OFF}	OFF

**Return Format** The query returns CHAN1, CHAN2, CHAN3, CHAN4, or OFF.

**Example** :MEASure:AMSource CHANnel1 /\*Sets the source to CHANnel1.\*/  
:MEASure:AMSource? /\*The query returns CHAN1.\*/

## :MEASure:SETup:MAX

**Syntax** :MEASure:SETup:MAX <value>

:MEASure:SETup:MAX?

**Description** Sets or queries the threshold level upper limit of the analog channel in auto measurement.

Parameter	Name	Type	Range	Default
	<value>	Integer	Refer to <b>Remarks</b>	---

- Remarks**
- When the threshold type is percentage, its range is from 0% to 100%; when the threshold type is absolute, its range is from -100 mV to 100 mV.
  - When the set upper limit is smaller than the current middle value, the middle value will be automatically reduced, so as to make itself to be smaller than the upper limit.

**Return Format** The query returns an integer.

**Example** :MEASure:SETup:MAX 95 /\*Sets the upper limit of the threshold level to 95%.\*/  
:MEASure:SETup:MAX? /\*The query returns 95.\*/

**:MEASure:SETup:MID****Syntax** :MEASure:SETup:MID <value>

:MEASure:SETup:MID?

**Description** Sets or queries the threshold level middle value of the analog channel in auto measurement.

Parameter	Name	Type	Range	Default
	<value>	Integer	Refer to <b>Remarks</b>	---

- Remarks**
- When the threshold type is percentage, its range is from 0% to 100%; when the threshold type is absolute, its range is from -100 mV to 100 mV.
  - The set middle value must be smaller than the currently set upper limit and greater than the currently set lower limit.

**Return Format** The query returns an integer.

**Example** :MEASure:SETup:MID 89 /\*Sets the middle value of the threshold level to 89%.\*/  
 :MEASure:SETup:MID? /\*The query returns 89.\*/

**:MEASure:SETup:MIN****Syntax** :MEASure:SETup:MIN <value>

:MEASure:SETup:MIN?

**Description** Sets or queries the threshold level lower limit of the analog channel in auto measurement.

Parameter	Name	Type	Range	Default
	<value>	Integer	Refer to <b>Remarks</b>	---

- Description**
- When the threshold type is percentage, its range is from 0% to 100%; when the threshold type is absolute, its range is from -100 mV to 100 mV.
  - When the lower limit is greater than the current middle value, the middle value will be automatically increased, so as to make itself greater than the lower limit.

**Return Format** The query returns an integer.

**Example** :MEASure:SETup:MIN 53 /\*Sets the lower limit of the threshold level to 53%.\*/  
 :MEASure:SETup:MIN? /\*The query returns 53.\*/

**:MEASure:SETup:PSA****Syntax** :MEASure:SETup:PSA <source>

:MEASure:SETup:PSA?

**Description** Sets or queries Source A in the phase or delay measurement.

Parameter	Name	Type	Range	Default
	<source>	Discrete	{D0 D1 D2 D3 D4 D5 D6 D7 D8 D9 D10 D11 D12 D13 D14 D15 CHANnel1 CHANnel2 CHANnel3 CHANnel4 MATH1 MATH2 MATH3 MATH4}	CHANnel1

**Return Format** The query returns D0, D1, D2, D3, D4, D5, D6, D7, D8, D9, D10, D11, D12, D13, D14, D15, CHAN1, CHAN2, CHAN3, CHAN4, MATH1, MATH2, MATH3, or MATH4.

**Example** :MEASure:SETup:PSA CHANnel1  
 /\*Sets Source A of the phase measurement to CHANnel1.\*/  
 :MEASure:SETup:PSA?  
 /\*The query returns CHAN1.\*/

## :MEASure:SETup:PSB

**Syntax** :MEASure:SETup:PSB <source>  
 :MEASure:SETup:PSB?

**Description** Sets or queries Source B in the phase or delay measurement.

Parameter	Name	Type	Range	Default
	<source>	Discrete	{D0 D1 D2 D3 D4 D5 D6 D7 D8 D9 D10 D11 D12 D13 D14 D15 CHANnel1 CHANnel2 CHANnel3 CHANnel4 MATH1 MATH2 MATH3 MATH4}	CHANnel2

**Return Format** The query returns D0, D1, D2, D3, D4, D5, D6, D7, D8, D9, D10, D11, D12, D13, D14, D15, CHAN1, CHAN2, CHAN3, CHAN4, MATH1, MATH2, MATH3, or MATH4.

**Example** :MEASure:SETup:PSB CHANnel2  
 /\*Sets Source B of the phase measurement to CHANnel2.\*/  
 :MEASure:SETup:PSB?  
 /\*The query returns CHAN2.\*/

## :MEASure:SETup:DSA

**Syntax** :MEASure:SETup:DSA <source>  
 :MEASure:SETup:DSA?

**Description** Sets or queries Source A in the phase or delay measurement.

Parameter	Name	Type	Range	Default
	<source>	Discrete	{D0 D1 D2 D3 D4 D5 D6 D7 D8 D9 D10 D11 D12 D13 D14 D15 CHANnel1 CHANnel2 CHANnel3 CHANnel4 MATH1 MATH2 MATH3 MATH4}	CHANnel1

**Remarks** This command has the same function as the [:MEASure:SETup:PSA](#) command.

**Return Format** The query returns D0, D1, D2, D3, D4, D5, D6, D7, D8, D9, D10, D11, D12, D13, D14, D15, CHAN1, CHAN2, CHAN3, CHAN4, MATH1, MATH2, MATH3, or MATH4.

**Example** :MEASure:SETup:DSA CHANnel1  
 /\*Sets Source A of the delay measurement to CHANnel1.\*/  
 :MEASure:SETup:DSA?  
 /\*The query returns CHAN1.\*/

**:MEASure:SETup:DSB**

**Syntax** :MEASure:SETup:DSB <source>

:MEASure:SETup:DSB?

**Description** Sets or queries Source B in the phase or delay measurement.

Parameter	Name	Type	Range	Default
<source>		Discrete	{D0 D1 D2 D3 D4 D5 D6 D7 D8 D9 D10 D11 D12 D13 D14 D15 CHANnel1 CHANnel2 CHANnel3 CHANnel4 MATH1 MATH2 MATH3 MATH4}	CHANnel1

**Remarks** This command has the same function as the [:MEASure:SETup:PSB](#) command.

**Return Format** The query returns D0, D1, D2, D3, D4, D5, D6, D7, D8, D9, D10, D11, D12, D13, D14, D15, CHAN1, CHAN2, CHAN3, CHAN4, MATH1, MATH2, MATH3, or MATH4.

**Example** :MEASure:SETup:DSB CHANnel2

```
/*Sets Source B of the delay measurement to CHANnel2.*/
```

```
:MEASure:SETup:DSB?
```

```
/*The query returns CHAN2.*/
```

**:MEASure:STATistic:DISPlay**

**Syntax** :MEASure:STATistic:DISPlay <bool>

:MEASure:STATistic:DISPlay?

**Description** Enables or disables the statistical function; or queries the status of the statistical function.

Parameter	Name	Type	Range	Default
<bool>		Bool	{{1 ON} {0 OFF}}	0 OFF

**Remarks** When the statistical function is enabled, the instrument makes statistics of the measurement results for at most 10 measurement items that are turned on last time and displays the statistical results.

**Return Format** The query returns 1 or 0.

**Example** :MEASure:STATistic:DISPlay ON /\*Enables the statistical function.\*/  
:MEASure:STATistic:DISPlay? /\*The query returns 1.\*/

**:MEASure:STATistic:RESet**

**Syntax** :MEASure:STATistic:RESet

**Description** Clears the history statistics data and makes statistics again.

**:MEASure:STATistic:ITEM**

**Syntax** :MEASure:STATistic:ITEM <item>[,<src>[,<src>]]

:MEASure:STATistic:ITEM? <type>,<item>[,<src>[,<src>]]

**Description** Enables the statistical function of any waveform parameter of the specified source, or queries the statistical results of any waveform parameter of the specified source.



Parameter	Name	Type	Range	Default
<item>		Discrete	{VMAX VMIN VPP VTOP VBASE VAMP VAVG VRMS OVERshoot PRESshoot MAREa MPAREa PERiod FREQuency RTIME FTIME PWIDth NWIDth PDUty NDUty TVMax TVMin PSLewrate NSLewrate VUPPer VMID VLOWer VARiance PVRMs PPULses NPULses PEDGes NEDGes RRDelay RFDelay FRDelay FFDelay RRPHase RFPHase FRPHase FFPHase}	---
<src>		Discrete	Refer to <a href="#">Remarks</a>	---
<type>		Discrete	{MAXimum MINimum CURRent AVERages DEVIation CNT}	---

- Remarks**
- The parameter [,<src>[,<src>]] is used to set the source of the parameter under measurement.
  - If the parameter <item> is set to PERiod, FREQuency, PWIDth, NWIDth, PDUty, NDUty, RRDelay, RFDelay, FRDelay, FFDelay, RRRPHase, RFPHase, FRPHase, or FFFPHase, the range of the parameter <src> is any one of the values in {D0|D1|D2|D3|D4|D5|D6|D7|D8|D9|D10|D11|D12|D13|D14|D15|CHANnel1|CHANnel2|CHANnel3|CHANnel4|MATH1|MATH2|MATH3|MATH4}.
  - If the measurement parameter is a single source, you only need to set one source. If this parameter is omitted, then the source is by default, selected by the [:MEASure:SOURce](#) command.
  - If the measurement parameter is a dual channel source, then the command sent must contain two sources. Otherwise, the command is invalid.

**Return Format** The query returns the statistical results in scientific notation.

**Example** :MEASure:STATistic:ITEM VPP,CHANnel2 /\*Enables the statistical function of the peak-peak value of CH2.\*/  
 :MEASure:STATistic:ITEM? MAXimum,VPP /\*The query returns 9.120000E-1.\*/

## :MEASure:ITEM

**Syntax** :MEASure:ITEM <item>[,<src>[,<src>]]  
 :MEASure:ITEM? <item>[,<src>[,<src>]]

**Description** Measures any waveform parameter of the specified source, or queries the statistical results of any waveform parameter of the specified source.

Parameter	Name	Type	Range	Default
<item>		Discrete	{VMAX VMIN VPP VTOP VBASE VAMP VAVG VRMS OVERshoot PRESshoot MAREa MPAREa PERiod FREQuency RTIME FTIME PWIDth NWIDth PDUty NDUty TVMax TVMin PSLewrate NSLewrate VUPPer VMID VLOWer VARiance PVRMs PPULses NPULses PEDGes NEDGes RRDelay RFDelay FRDelay FFDelay RRPHase RFPHase FRPHase FFPHase}	---
<src>		Discrete	Refer to <a href="#">Remarks</a>	---

- Remarks**
- The parameter [,<src>[,<src>]] is used to set the source of the parameter under measurement.
  - If the parameter <item> is set to PERiod, FREQuency, PWIDth, NWIDth, PDUTy, NDUTy, RRDelay, RFDelay, FRDelay, FFDelay, RRPHase, RFPHase, FRPHase, or FFPHase, the range of the parameter <src> is any one of the values in {D0|D1|D2|D3|D4|D5|D6|D7|D8|D9|D10|D11|D12|D13|D14|D15|CHANnel1|CHANnel2|CHANnel3|CHANnel4|MATH1|MATH2|MATH3|MATH4}.
  - If the measurement parameter is a single source, you only need to set one source. If this parameter is omitted, then the source is by default, selected by the [:MEASure:SOURce](#) command.
  - If the measurement parameter is a dual channel source, then the command sent must contain two sources. Otherwise, the command is invalid.
- Return Format** The query returns the current measurement value in scientific notation.
- Example**
- ```
:MEASure:ITEM OVERshoot,CHANnel2 /*Enables the overshoot measurement of CH2.*/
:MEASure:ITEM? OVERshoot,CHANnel2 /*The query returns 8.888889E-3.*/
```

## :MEASure:AREA

**Syntax** :MEASure:AREA <area>  
:MEASure:AREA?

**Description** Sets or queries the type of the measurement range.

| Parameter | Name   | Type     | Range              | Default |
|-----------|--------|----------|--------------------|---------|
|           | <area> | Discrete | {MAIN ZOOM CURSor} | MAIN    |

- Remarks**
- MAIN: indicates that the measurement range is within the main time base region.
  - ZOOM: indicates that the measurement range is within the zoomed time base region. Note that only when you enable the delayed sweep function first, can "Zoom" be enabled.
  - CURSor: when you select it, two cursor lines will be displayed on the screen.

**Return Format** The query returns MAIN, ZOOM, or CURS.

**Example**

```
:MEASure:AREA ZOOM /*Sets the type of the measurement range to ZOOM.*/
:MEASure:AREA? /*The query returns ZOOM.*/
```

## :MEASure:CREGion:CAX

**Syntax** :MEASure:CREGion:CAX <cax>  
:MEASure:CREGion:CAX?

**Description** Sets or queries the position of Cursor A when the measurement range is the "cursor region".

| Parameter | Name  | Type    | Range    | Default |
|-----------|-------|---------|----------|---------|
|           | <cax> | Integer | 0 to 999 | 600     |

- Remarks**
- The position of the cursor is defined by the pixel coordinate of the screen. The

range of the pixel coordinate on the screen horizontally is from 0 to 999 (from left to right).

- You can run the [:MEASure:AREA](#) command to set the measurement range to "cursor region".

**Return Format** The query returns the position of Cursor A in integer.

**Example** :MEASure:CREGion:CAX 100 /\*Sets the position of Cursor A to 100.\*/  
:MEASure:CREGion:CAX? /\*The query returns 100.\*/\*

## :MEASure:CREGion:CBX

**Syntax** :MEASure:CREGion:CBX <cbx>  
:MEASure:CREGion:CBX?

**Description** Sets or queries the position of Cursor B when the measurement range is the "cursor region".

| Parameter | Name  | Type    | Range    | Default |
|-----------|-------|---------|----------|---------|
|           | <cbx> | Integer | 0 to 999 | 600     |

- Remarks**
- The position of the cursor is defined by the pixel coordinate of the screen. The range of the pixel coordinate on the screen horizontally is from 0 to 999 (from left to right).
  - You can run the [:MEASure:AREA](#) command to set the measurement range to "cursor region".

**Return Format** The query returns the position of Cursor B in integer.

**Example** :MEASure:CREGion:CBX 100 /\*Sets the position of Cursor B to 100.\*/  
:MEASure:CREGion:CBX? /\*The query returns 100.\*/\*

## :MEASure:CATegory

**Syntax** :MEASure:CATegory <val>  
:MEASure:CATegory?

**Description** Sets or queries the measurement type.

| Parameter | Name  | Type    | Range  | Default |
|-----------|-------|---------|--------|---------|
|           | <val> | Integer | 0 to 2 | 0       |

**Remarks** 0: horizontal; 1: vertical; 2: other

**Return Format** The query returns an integer ranging from 0 to 2.

**Example** :MEASure:CATegory 1 /\*Sets the vertical measurement.\*/  
:MEASure:CATegory? /\*The query returns 1.\*/\*

## :POWer Commands

### Command List:

- ◆ [:POWer:TYPE](#)
- ◆ [:POWer:CURRentsource](#)
- ◆ [:POWer:VOLTagesource](#)
- ◆ [:POWer:QUALity:FREOREFERENCE](#)
- ◆ [:POWer:REFLevel:METHOD](#)
- ◆ [:POWer:REFLevel:PERCent:HIGH](#)
- ◆ [:POWer:REFLevel:PERCent:LOW](#)
- ◆ [:POWer:REFLevel:PERCent:MID](#)

### :POWer:TYPE

**Syntax** :POWer:TYPE <type>

:POWer:TYPE?

**Description** Sets or queries the power analysis type.

| Parameter | Name   | Type     | Range            | Default |
|-----------|--------|----------|------------------|---------|
|           | <type> | Discrete | {QUALity RIPple} | QUALity |

- Description**
- QUALity: By analyzing the power quality, you can test the quality of AC input lines.
  - RIPple: indicates the ripple quantity of the output DC voltage.

**Return Format** The query returns QUAL or RIPP.

**Example** :POWer:TYPE RIPple /\*Sets the power analysis type to RIPple.\*/  
:POWer:TYPE? /\*The query returns RIPP.\*/\*

### :POWer:CURRentsource

**Syntax** :POWer:CURRentsource <source>

:POWer:CURRentsource?

**Description** Sets or queries the current source of power quality.

| Parameter | Name     | Type     | Range                                 | Default  |
|-----------|----------|----------|---------------------------------------|----------|
|           | <source> | Discrete | {CHANnel1 CHANnel2 CHANnel3 CHANnel4} | CHANnel1 |

**Return Format** The query returns CHAN1, CHAN2, CHAN3, or CHAN4.

**Example** :POWer:CURRentsource CHANnel2 /\*Sets the current source to CHANnel2.\*/  
:POWer:CURRentsource? /\*The query returns CHAN2.\*/\*

**:POWer:VOLTagesource**

**Syntax** :POWer:VOLTagesource <source>

:POWer:VOLTagesource?

**Description** Sets or queries the voltage source of power quality.

| Parameter | Name     | Type     | Range                                 | Default  |
|-----------|----------|----------|---------------------------------------|----------|
|           | <source> | Discrete | {CHANnel1 CHANnel2 CHANnel3 CHANnel4} | CHANnel1 |

**Return Format** The query returns CHAN1, CHAN2, CHAN3, or CHAN4.

**Example** :POWer:VOLTagesource CHANnel2      /\*Sets the voltage source to CHANnel2.\*/  
:POWer:VOLTagesource?                      /\*The query returns CHAN2.\*/\*

**:POWer:QUALity:FREQREFerence**

**Syntax** :POWer:QUALity:FREQREFerence <source>

:POWer:QUALity:FREQREFerence?

**Description** Sets or queries the frequency reference source of power quality.

| Parameter | Name     | Type     | Range             | Default |
|-----------|----------|----------|-------------------|---------|
|           | <source> | Discrete | {VOLTage CURRent} | VOLTage |

**Return Format** The query returns VOLT or CURR.

**Example** :POWer:QUALity:FREQREFerence CURRent      /\*Sets the frequency reference source of  
power quality to CURRent.\*/  
:POWer:QUALity:FREQREFerence?                      /\*The query returns CURR.\*/\*

**:POWer:REFLevel:METHod**

**Syntax** :POWer:REFLevel:METHod <method>

:POWer:REFLevel:METHod?

**Description** Sets or queries the reference level type of power quality.

| Parameter | Name     | Type     | Range              | Default |
|-----------|----------|----------|--------------------|---------|
|           | <method> | Discrete | {ABSolute PERCent} | PERCent |

**Return Format** The query returns ABS or PERC.

**Example** :POWer:REFLevel:METHod ABSolute      /\*Sets the reference level type of power quality  
to ABSolute.\*/  
:POWer:REFLevel:METHod?                      /\*The query returns ABS.\*/\*

**:POWer:REFLevel:PERCent:HIGH****Syntax** :POWer:REFLevel:PERCent:HIGH <value>

:POWer:REFLevel:PERCent:HIGH?

**Description** Sets or queries the reference level percentage upper limit of power quality.

| Parameter | Name    | Type    | Range             | Default |
|-----------|---------|---------|-------------------|---------|
|           | <value> | Integer | (median+1) to 100 | 0       |

**Remarks** upper limit>median>lower limit**Return Format** The query returns an integer ranging from (median+1) to 100.

**Example** :POWer:REFLevel:PERCent:HIGH 20 /\*Sets the reference level percentage upper limit of power quality to 20%.\*/

:POWer:REFLevel:PERCent:HIGH? /\*The query returns 20.\*/

**:POWer:REFLevel:PERCent:LOW****Syntax** :POWer:REFLevel:PERCent:LOW <value>

:POWer:REFLevel:PERCent:LOW?

**Description** Sets or queries the reference level percentage lower limit of power quality.

| Parameter | Name    | Type    | Range           | Default |
|-----------|---------|---------|-----------------|---------|
|           | <value> | Integer | (median-1) to 0 | 0       |

**Return Format** The query returns an integer ranging from (median-1) to 0.

**Example** :POWer:REFLevel:PERCent:LOW 20 /\*Sets the reference level percentage lower limit of power quality to 20%.\*/

:POWer:REFLevel:PERCent:LOW? /\*The query returns 20.\*/

**:POWer:REFLevel:PERCent:MID****Syntax** :POWer:REFLevel:PERCent:MID <value>

:POWer:REFLevel:PERCent:MID?

**Description** Sets or queries the reference level percentage median of power quality.

| Parameter | Name    | Type    | Range                              | Default |
|-----------|---------|---------|------------------------------------|---------|
|           | <value> | Integer | (upper limit-1) to (lower limit+1) | 0       |

**Return Format** The query returns an integer ranging from (upper limit-1) to (lower limit+1).

**Example** :POWer:REFLevel:PERCent:MID 20 /\*Sets the reference level percentage median of power quality to 20%.\*/

:POWer:REFLevel:PERCent:MID? /\*The query returns 20.\*/

## :Quick Command

The :Quick commands are used to set and query the relevant parameters for shortcut keys.

### Command List:

◆ [:Quick:OPERation](#)

## :Quick:OPERation

**Syntax** :Quick:OPERation <type>

:Quick:OPERation?

**Description** Sets or queries the type of the shortcut keys.

### Parameter

| Name   | Type     | Range                                 | Default |
|--------|----------|---------------------------------------|---------|
| <type> | Discrete | {SIMage SWAVe SSETup AMEasure SRESet} | SIMage  |

### Remarks

SIMage: indicates the screen image.  
 SWAVe: indicates the waveform saving.  
 SSETup: indicates the setup saving.  
 AMEasure: indicates all measurement.  
 SRESet: indicates statistics reset.

### Return Format

The query returns SIM, SWAV, SSET, AME, or SRES.

### Example

```
:Quick:OPERation SWAVe /*Sets the type of the shortcut key to SWAVe.*/  
:Quick:OPERation? /*The query returns SWAV.*/*
```

## :RECORD Commands

### Command List:

- ◆ [:RECORD:ENABLE](#)
- ◆ [:RECORD:START](#)
- ◆ [:RECORD:PLAY](#)
- ◆ [:RECORD:CURRENT](#)
- ◆ [:RECORD:FRAMES](#)

### :RECORD:ENABLE

**Syntax** :RECORD:ENABLE <bool>  
:RECORD:ENABLE?

**Description** Enables or disables the waveform recording function; or queries the on/off status of the waveform recording function.

| Parameter | Name   | Type | Range              | Default |
|-----------|--------|------|--------------------|---------|
|           | <bool> | Bool | {{1 ON}} {{0 OFF}} | 0 OFF   |

**Return Format** The query returns 1 or 0.

**Example** :RECORD:ENABLE ON /\*Enables the waveform recording function.\*/  
:RECORD:ENABLE? /\*The query returns 1.\*/\*

### :RECORD:START

**Syntax** :RECORD:START <bool>  
:RECORD:START?

**Description** Sets to start the waveform recording, or queries whether the waveform recording starts or stops.

| Parameter | Name   | Type | Range              | Default |
|-----------|--------|------|--------------------|---------|
|           | <bool> | Bool | {{1 ON}} {{0 OFF}} | 0 OFF   |

**Return Format** The query returns 1 or 0.

**Example** :RECORD:START ON /\*Sets to start recording the waveforms.\*/  
:RECORD:START? /\*The query returns 1.\*/\*



**:RECOrd:PLAY****Syntax** :RECOrd:PLAY <bool>

:RECOrd:PLAY?

**Description** Enables or disables the waveform playing function; or queries the on/off status of the waveform playing function.

| Parameter | Name   | Type | Range            | Default |
|-----------|--------|------|------------------|---------|
|           | <bool> | Bool | {{1 ON} {0 OFF}} | 0 OFF   |

**Return Format** The query returns 1 or 0.

**Example** :RECOrd:PLAY ON /\*Sets to play the waveforms.\*/  
 :RECOrd:PLAY? /\*The query returns 1.\*/

**:RECOrd:CURREnt****Syntax** :RECOrd:CURREnt <value>

:RECOrd:CURREnt?

**Description** Sets or queries the current frame in waveform playing.

| Parameter | Name    | Type    | Range                                      | Default                               |
|-----------|---------|---------|--------------------------------------------|---------------------------------------|
|           | <value> | Integer | 1 to the maximum number of frames recorded | The maximum number of frames recorded |

**Return Format** The query returns an integer.

**Example** :RECOrd:CURREnt 300 /\*Sets the current frame for waveform playing to 300.\*/  
 :RECOrd:CURREnt? /\*The query returns 300.\*/

**:RECOrd:FRAMes****Syntax** :RECOrd:FRAMes <value>

:RECOrd:FRAMes?

**Description** Sets or queries the number of frames for waveform recording.

| Parameter | Name    | Type    | Range                                                            | Default |
|-----------|---------|---------|------------------------------------------------------------------|---------|
|           | <value> | Integer | 1 to the maximum number of frames that can be recorded currently | 1,000   |

**Return Format** The query returns an integer ranging from 1 to the maximum number of frames that can be recorded currently.

**Example** :RECOrd:FRAMes 300 /\*Sets the number of recorded frames to 300.\*/  
 :RECOrd:FRAMes? /\*The query returns 300.\*/

## :REference Commands

The :REference commands are used to set relevant parameters for reference waveforms.

### Command List:

- ◆ [:REference:DISPlay](#)
- ◆ [:REference:SOURce](#)
- ◆ [:REference:VSCale](#)
- ◆ [:REference:VOFFset](#)
- ◆ [:REference:RESet](#)
- ◆ [:REference:CURRent](#)
- ◆ [:REference:SAVE](#)
- ◆ [:REference:COLor](#)
- ◆ [:REference:LABel:ENABle](#)
- ◆ [:REference:LABel:CONTent](#)

### :REference:DISPlay

**Syntax** :REference:DISPlay <bool>

:REference:DISPlay?

**Description** Turns on or off the REF function; or queries the on/off status of the REF function.

| Parameter | Name   | Type | Range            | Default |
|-----------|--------|------|------------------|---------|
|           | <bool> | Bool | {{1 ON} {0 OFF}} | 0 OFF   |

**Return Format** The query returns 1 or 0.

**Example** :REference:DISPlay ON /\*Enables the REF function.\*/  
:REference:DISPlay? /\*The query returns 1.\*/\*

### :REference:SOURce

**Syntax** :REference:SOURce <ref>,<chan>

:REference:SOURce? <ref>

**Description** Sets or queries the source of the specified reference channel.

| Parameter | Name     | Type     | Range                                                                                                               | Default  |
|-----------|----------|----------|---------------------------------------------------------------------------------------------------------------------|----------|
|           | <ref>    | Discrete | {1 2 3 4 5 6 7 8 9 10}                                                                                              | ---      |
|           | <source> | Discrete | {D0 D1 D2 D3 D4 D5 D6 D7 D8 D9 D10 D11 D12 D13 D14 D15 CHANnel1 CHANnel2 CHANnel3 CHANnel4 MATH1 MATH2 MATH3 MATH4} | CHANnel1 |

**Remarks** Only the currently enabled channel can be selected as the source of the specified reference channel.

**Return** The query returns D0, D1, D2, D3, D4, D5, D6, D7, D8, D9, D10, D11, D12, D13, D14,

**Format** D15, CHAN1, CHAN2, CHAN3, CHAN4, MATH1, MATH2, MATH3, or MATH4.

**Example** :REfERENCE:SOURce 1,CHANnel1 /\*Sets the source of the reference channel 1 to CHANnel1.\*/

:REfERENCE:SOURce? 1 /\*The query returns CHAN1.\*/

## :REfERENCE:VSCale

**Syntax** :REfERENCE:VSCale <ref>,<scale>

:REfERENCE:VSCale? <ref>

**Description** Sets or queries the vertical scale of the specified reference channel. The unit is the same as that of the current source.

| Parameter | Name    | Type     | Range                                                                                                                                                                                             | Default |
|-----------|---------|----------|---------------------------------------------------------------------------------------------------------------------------------------------------------------------------------------------------|---------|
|           | <ref>   | Discrete | {1 2 3 4 5 6 7 8 9 10}                                                                                                                                                                            | ---     |
|           | <scale> | Real     | Related to the probe ratio setting<br>When the probe ratio is 1X, the value of <scale> ranges from 1 mV to 10 V.<br>When the probe ratio is 10X, the value of <scale> ranges from 10 mV to 100 V. | 1 V     |

**Remarks** This command is only available when the specified reference channel has saved the reference waveforms.

**Return Format** The query returns the vertical scale in scientific notation.

**Example** :REfERENCE:VSCale 1,2 /\*Sets the vertical scale of reference channel 1 to 2 V.\*/  
:REfERENCE:VSCale? 1 /\*The query returns 2.000000E0.\*/

## :REfERENCE:VOFFset

**Syntax** :REfERENCE:VOFFset <ref>,<offset>

:REfERENCE:VOFFset? <ref>

**Description** Sets or queries the vertical offset of the specified reference channel. The unit is the same as that of the current source.

| Parameter | Name     | Type     | Range                                               | Default |
|-----------|----------|----------|-----------------------------------------------------|---------|
|           | <ref>    | Discrete | {1 2 3 4 5 6 7 8 9 10}                              | ---     |
|           | <offset> | Real     | (-10 × RefVerticalScale) to (10 × RefVerticalScale) | 0 V     |

**Remarks** RefVerticalScale indicates the vertical scale of the currently set reference channel.

**Return Format** The query returns the vertical offset in scientific notation.

**Example** :REfERENCE:VOFFset 1,0.5 /\*Sets the vertical offset of reference channel 1 to 500 mV.\*/

:REfERENCE:VOFFset? 1 /\*The query returns 5.000000E-1.\*/

**:REfERENCE:RESet**

**Syntax** :REfERENCE:RESet <ref>

**Description** Resets the vertical scale and vertical offset of the specified reference channel to the defaults.

| Parameter | Name  | Type     | Range                  | Default |
|-----------|-------|----------|------------------------|---------|
|           | <ref> | Discrete | {1 2 3 4 5 6 7 8 9 10} | ---     |

**:REfERENCE:CURRent**

**Syntax** :REfERENCE:CURRent <ref>

**Description** Selects the specified reference channel.

| Parameter | Name  | Type     | Range                  | Default |
|-----------|-------|----------|------------------------|---------|
|           | <ref> | Discrete | {1 2 3 4 5 6 7 8 9 10} | 1       |

**Remarks** Only the currently enabled channel can be selected as the current reference channel.

**:REfERENCE:SAVE**

**Syntax** :REfERENCE:SAVE <ref>

**Description** Saves the waveform of the specified reference channel to the internal memory as the reference waveform.

| Parameter | Name  | Type     | Range                  | Default |
|-----------|-------|----------|------------------------|---------|
|           | <ref> | Discrete | {1 2 3 4 5 6 7 8 9 10} | ---     |

**:REfERENCE:COLor**

**Syntax** :REfERENCE:COLor <ref>,<color>

:REfERENCE:COLor? <ref>

**Description** Sets or queries the display color of the specified reference channel.

| Parameter | Name    | Type     | Range                        | Default |
|-----------|---------|----------|------------------------------|---------|
|           | <ref>   | Discrete | {1 2 3 4 5 6 7 8 9 10}       | ---     |
|           | <color> | Discrete | {GRAY GREen BLUE RED ORANge} | GRAY    |

**Return Format** The query returns GRAY, GRE, BLUE, RED, or ORAN.

**Example** :REfERENCE:COLor 1,GREen /\*Sets the display color of the reference channel 1 to GREen.\*/

:REfERENCE:COLor? 1 /\*The query returns GRE.\*/

**:REfERENCE:LABel:ENABle**

**Syntax** :REfERENCE:LABel:ENABle <bool>

:REfERENCE:LABel:ENABle?

**Description** Enables or disables the display of all the labels; or queries the on/off display of all the labels.

| Parameter | Name   | Type | Range            | Default |
|-----------|--------|------|------------------|---------|
|           | <bool> | Bool | {{1 ON} {0 OFF}} | 0 OFF   |

**Return Format** The query returns 1 or 0.

**Example** :REfERENCE:LABel:ENABle ON /\*Enables the display of all the labels.\*/  
:REfERENCE:LABel:ENABle? /\*The query returns 1.\*/\*

**:REfERENCE:LABel:CONTent**

**Syntax** :REfERENCE:LABel:CONTent <ref>,<str>

:REfERENCE:LABel:CONTent? <ref>

**Description** Sets or queries the label of the specified reference channel.

| Parameter | Name  | Type         | Range                                                                        | Default |
|-----------|-------|--------------|------------------------------------------------------------------------------|---------|
|           | <ref> | Discrete     | {1 2 3 4 5 6 7 8 9 10}                                                       | ---     |
|           | <str> | ASCII String | The string can contain English letters and numbers, as well as some symbols. | ---     |

**Return Format** The query returns the label of the specified reference channel in strings.

**Example** :REfERENCE:LABel:CONTent 1,REF1 /\*Sets the label of reference channel 1 to REF1.\*/  
:REfERENCE:LABel:CONTent? 1 /\*The query returns REF1.\*/\*

## :SAVE and :Load Commands

### Command List:

- ◆ [:SAVE:CSV](#)
- ◆ [:SAVE:CSV:LENGth](#)
- ◆ [:SAVE:FORMat](#)
- ◆ [:SAVE:IMAGe](#)
- ◆ [:SAVE:IMAGe:TYPE](#)
- ◆ [:SAVE:IMAGe:INVert](#)
- ◆ [:SAVE:IMAGe:COLor](#)
- ◆ [:SAVE:SETup](#)
- ◆ [:SAVE:WAVeform](#)
- ◆ [:SAVE:STATus?](#)
- ◆ [:LOAD:SETup](#)

### :SAVE:CSV

**Syntax** :SAVE:CSV<path>

**Description** Saves the waveform data displayed on the screen to the internal or external memory in ".csv" format.

| Parameter | Name   | Type         | Range                            | Default |
|-----------|--------|--------------|----------------------------------|---------|
|           | <path> | ASCII String | Refer to <a href="#">Remarks</a> | ---     |

- Remarks**
- <path> includes the file storage location and the filename with a suffix. If the specified storage location already contains a file with the same filename, the original file will be overwritten.
  - The stored ".csv" file can be opened and edited in Excel.

**Example** :SAVE:CSV D:\123.csv /\*Stores the waveform data displayed on the screen into the external memory Disk D, with the filename 123.csv.\*/

### :SAVE:CSV:LENGth

**Syntax** :SAVE:CSV:LENGth <len>  
:SAVE:CSV:LENGth?

**Description** Sets or queries the data length type in saving the ".csv" file.

| Parameter | Name  | Type     | Range             | Default |
|-----------|-------|----------|-------------------|---------|
|           | <len> | Discrete | {DISPlay MAXimum} | DISPlay |

- Remarks**
- DISPlay: only stores the points within the screen region, i.g. 1 kpts.
  - MAXimum: stores all the points in the internal memory (equal to the current memory depth).

**Return Format** The query returns DISP or MAX.

**Example** :SAVE:CSV:LENGth MAXimum /\*Sets the data length type to MAXimum.\*/  
:SAVE:CSV:LENGth? /\*The query returns MAX.\*/\*

## :SAVE:FORMat

**Syntax** :SAVE:FORMat <format>  
:SAVE:FORMat?

**Description** Sets or queries the storage format.

| Parameter | Name     | Type     | Range                              | Default |
|-----------|----------|----------|------------------------------------|---------|
|           | <format> | Discrete | {TRACe WAVEform SETup PICTure CSV} | PICTure |

**Return Format** The query returns TRAC, WAV, SET, PICT, or CSV.

**Example** :SAVE:FORMat TRACe /\*Sets the storage format to TRACe.\*/  
:SAVE:FORMat? /\*The query returns TRAC.\*/\*

## :SAVE:IMAGe

**Syntax** :SAVE:IMAGe<path>

**Description** Stores the contents displayed on the screen into the internal or external memory in image format.

| Parameter | Name   | Type         | Range                   | Default |
|-----------|--------|--------------|-------------------------|---------|
|           | <path> | ASCII String | Refer to <b>Remarks</b> | ---     |

**Remarks** <path> includes the file storage location and the filename with a suffix. The suffix of the filename can be .bmp, .png, .jpg, or .tif. If the specified storage location already contains a file with the same filename, the original file will be overwritten.

**Example** :SAVE:IMAGe D:\123.png /\*Stores the contents displayed on the screen into the external memory Disk D, with the filename 123.png\*/

## :SAVE:IMAGe:TYPE

**Syntax** :SAVE:IMAGe:TYPE <type>  
:SAVE:IMAGe:TYPE?

**Description** Sets or queries in what format is the image saved.

| Parameter | Name   | Type     | Range                 | Default |
|-----------|--------|----------|-----------------------|---------|
|           | <type> | Discrete | {BMP24 JPEG PNG TIFF} | PNG     |

**Return Format** The query returns BMP24, JPEG, PNG, or TIFF.

**Example** :SAVE:IMAGe:TYPE JPEG /\*Sets the image storage format to JPEG.\*/  
:SAVE:IMAGe:TYPE? /\*The query returns JPEG.\*/\*

**:SAVE:IMAGe:INVert****Syntax** :SAVE:IMAGe:INVert <bool>

:SAVE:IMAGe:INVert?

**Description** Enables or disables the invert function when saving the image; or queries whether the invert function is enabled when saving the image.

| Parameter | Name   | Type | Range            | Default |
|-----------|--------|------|------------------|---------|
|           | <bool> | Bool | {{1 ON} {0 OFF}} | 0 OFF   |

**Return** The query returns 1 or 0.**Format**

**Example** :SAVE:IMAGe:INVert ON /\*Enables the invert function when saving the image.\*/  
 :SAVE:IMAGe:INVert? /\*The query returns 1.\*/\*

**:SAVE:IMAGe:COLor****Syntax** :SAVE:IMAGe:COLor <bool>

:SAVE:IMAGe:COLor?

**Description** Sets the image color for image saving to Color or Gray; or queries image color for image saving.

| Parameter | Name   | Type | Range        | Default |
|-----------|--------|------|--------------|---------|
|           | <bool> | Bool | {COLor GRAY} | COLor   |

**Return** The query returns COL or GRAY.**Format**

**Example** :SAVE:IMAGe:COLor GRAY /\*Sets the image color for image saving to GRAY.\*/  
 :SAVE:IMAGe:COLor? /\*The query returns GRAY.\*/\*

**:SAVE:SETup****Syntax** :SAVE:SETup<path>**Description** Saves the current setup parameters of the oscilloscope to the internal or external memory as a file.

| Parameter | Name   | Type         | Range                   | Default |
|-----------|--------|--------------|-------------------------|---------|
|           | <path> | ASCII String | Refer to <b>Remarks</b> | ---     |

- Remarks**
- In the internal storage, if a file already exists in the specified storage location, the original file will be overwritten.
  - In the external storage, <path> includes the file storage location and the filename with a suffix. If the specified storage location already contains a file with the same filename, the original file will be overwritten.

**Example** :SAVE:SETup D:\123.stp /\*Stores the current setup parameters of the oscilloscope into the external memory Disk D, with the filename 123.stp.\*/\*



**:SAVE:WAVeform**

**Syntax** :SAVE:WAVeform<path>

**Description** Saves the waveform data to the internal or external memory as a file.

| Parameter | Name   | Type         | Range                   | Default |
|-----------|--------|--------------|-------------------------|---------|
|           | <path> | ASCII String | Refer to <b>Remarks</b> | ---     |

**Remarks** <path> includes the file storage location and the filename with a suffix. By default, its suffix is in ".bin" format. The filename suffixed with ".csv" and ".wfm" are also supported. If the specified storage location already contains a file with the same filename, the original file will be overwritten.

**Example** :SAVE:WAVeform D:\123.wfm /\*Saves the waveform file to the external memory Disk D, with the filename 123.wfm.\*/

**:SAVE:STATus?**

**Syntax** :SAVE:STATus?

**Description** Queries the saving status of the internal memory or the external USB storage device.

**Return Format** The query returns 0 or 1 (when the saving operation is completed).

**:LOAD:SETup**

**Syntax** :LOAD:SETup <path>

**Description** Loads the setup file of the oscilloscope from the specified path.

| Parameter | Name   | Type         | Range                   | Default |
|-----------|--------|--------------|-------------------------|---------|
|           | <path> | ASCII String | Refer to <b>Remarks</b> | ---     |

**Remarks** <path> includes the file storage location and the filename with a suffix. By default, its suffix is in ".stp" format. If the specified storage location already contains a file with the same filename, the original file will be overwritten.

**Example** :LOAD:SETup D:\123.stp /\*Loads the setup file "123.stp" from the external memory Disk D.\*/

## :SEARch Commands

### Command List:

- ◆ [:SEARch:STATe](#)
- ◆ [:SEARch:MODE](#)
- ◆ [:SEARch:EVENT](#)
- ◆ [:SEARch:EDGE:SLOPe](#)
- ◆ [:SEARch:EDGE:SOURce](#)
- ◆ [:SEARch:PULSe:POLarity](#)
- ◆ [:SEARch:PULSe:QUALifier](#)
- ◆ [:SEARch:PULSe:SOURce](#)
- ◆ [:SEARch:RUNT:POLarity](#)
- ◆ [:SEARch:RUNT:QUALifier](#)
- ◆ [:SEARch:RUNT:SOURce](#)
- ◆ [:SEARch:SLOPe:POLarity](#)
- ◆ [:SEARch:SLOPe:QUALifier](#)
- ◆ [:SEARch:SLOPe:SOURce](#)

## :SEARch:STATe

**Syntax** :SEARch:STATe <bool>

:SEARch:STATe?

**Description** Enables or disables the search function; or queries the on/off status of the search function.

### Parameter

| Name   | Type | Range              | Default |
|--------|------|--------------------|---------|
| <bool> | Bool | {{1 ON}} {{0 OFF}} | 0 OFF   |

**Return** The query returns 1 or 0.

### Format

**Example** :SEARch:STATe ON /\*Enables the search function.\*/  
:SEARch:STATe? /\*The query returns 1.\*/\*

**:SEARCh:MODE**

**Syntax** :SEARCh:MODE <value>

:SEARCh:MODE?

**Description** Sets the search type.

| Parameter | Name    | Type | Range                                 | Default |
|-----------|---------|------|---------------------------------------|---------|
|           | <value> | Bool | {EDGE PULSe RUNT SLOPe RS232 I2C SPI} | EDGE    |

- Remarks**
- EDGE: selects "Edge" as the search type.
  - PULSe: selects "Pulse" as the search type.
  - RUNT: selects "Runt" as the search type.
  - SLOPe: selects "Slope" as the search type.
  - RS232: selects "RS232" as the search type.
  - I2C: selects "I2C" as the search type.
  - SPI: selects "SPI" as the search type.

**Return Format** The query returns EDGE, PULS, RUNT, SLOP, RS232, I2C, or SPI.

**Example** :SEARCh:MODE PULSe /\*Selects the search type to PULSe.\*/  
:SEARCh:MODE? /\*The query returns PULS.\*/

**:SEARCh:EVENT**

**Syntax** :SEARCh:EVENT <value>

:SEARCh:EVENT?

**Description** Sets to navigate a search event.

| Parameter | Name    | Type    | Range                                    | Default |
|-----------|---------|---------|------------------------------------------|---------|
|           | <value> | Integer | 0 to (the number of searched events – 1) | 0       |

**Return Format** The query returns an integer.

**Example** :SEARCh:EVENT 1 /\*Sets to navigate to Search Event 1.\*/  
:SEARCh:EVENT? /\*The query returns 1.\*/

**:SEARCh:EDGE:SLOPe**

**Syntax** :SEARCh:EDGE:SLOPe <slope>

:SEARCh:EDGE:SLOPe?

**Description** Sets or queries the edge for the "Edge" search type.

| Parameter | Name    | Type     | Range                      | Default  |
|-----------|---------|----------|----------------------------|----------|
|           | <slope> | Discrete | {POSitive NEGative EITHer} | POSitive |

- Remarks**
- POSitive: indicates the rising edge.
  - NEGative: indicates the falling edge.
  - EITHer: indicates the rising or falling edge.

**Return Format** The query returns POS, NEG, or EITH.

**Example** :SEARch:EDGE:SLOPe NEGative /\*Sets the edge type to NEGative.\*/  
:SEARch:EDGE:SLOPe? /\*The query returns NEG.\*/\*

## :SEARch:EDGE:SOURce

**Syntax** :SEARch:EDGE:SOURce <source>  
:SEARch:EDGE:SOURce?

**Description** Sets or queries the source for the "Edge" search type.

| Parameter | Name     | Type     | Range                                 | Default  |
|-----------|----------|----------|---------------------------------------|----------|
|           | <source> | Discrete | {CHANnel1 CHANnel2 CHANnel3 CHANnel4} | CHANnel1 |

**Return Format** The query returns CHAN1, CHAN2, CHAN3, or CHAN4.

**Example** :SEARch:EDGE:SOURce CHANnel1 /\*Sets the source to CHANnel1.\*/  
:SEARch:EDGE:SOURce? /\*The query returns CHAN1.\*/\*

## :SEARch:PULSe:POLarity

**Syntax** :SEARch:PULSe:POLarity <polarity>  
:SEARch:PULSe:POLarity?

**Description** Sets or queries the polarity for "Pulse" search type.

| Parameter | Name       | Type     | Range               | Default  |
|-----------|------------|----------|---------------------|----------|
|           | <polarity> | Discrete | {POSitive NEGative} | POSitive |

**Return Format** The query returns POS or NEG.

**Example** :SEARch:PULSe:POLarity POSitive /\*Sets the polarity for "Pulse" search type to POSitive.\*/  
:SEARch:PULSe:POLarity? /\*The query returns POS.\*/\*

## :SEARch:PULSe:QUALifier

**Syntax** :SEARch:PULSe:QUALifier <qualifier>  
:SEARch:PULSe:QUALifier?

**Description** Sets or queries the search condition for "Pulse" search type.

| Parameter | Name        | Type     | Range                | Default |
|-----------|-------------|----------|----------------------|---------|
|           | <qualifier> | Discrete | {GREater LESS GLESS} | GREater |

- Remarks**
- GREater: the positive/negative pulse width of the input signal is greater than the specified pulse width.
  - LESS: the positive/negative pulse width of the input signal is smaller than the specified pulse width.

- GLESSs: the positive/negative pulse width of the input signal is greater than the specified lower limit of pulse width and smaller than the specified upper limit of pulse width.

**Return Format** The query returns GRE, LESS, or GLESS.

**Example** :SEARCh:PULSe:QUALifier LESS /\*Sets the search condition for "Pulse" search type to LESS.\*/  
:SEARCh:PULSe:QUALifier? /\*The query returns LESS.\*/\*

## :SEARCh:PULSe:SOURce

**Syntax** :SEARCh:PULSe:SOURce <source>  
:SEARCh:PULSe:SOURce?

**Description** Sets or queries the source for "Pulse" search type.

| Parameter | Name     | Type     | Range                                 | Default  |
|-----------|----------|----------|---------------------------------------|----------|
|           | <source> | Discrete | {CHANnel1 CHANnel2 CHANnel3 CHANnel4} | CHANnel1 |

**Return Format** The query returns CHAN1, CHAN2, CHAN3, or CHAN4.

**Example** :SEARCh:PULSe:SOURce CHANnel1 /\*Sets the source to CHANnel1.\*/  
:SEARCh:PULSe:SOURce? /\*The query returns CHAN1.\*/\*

## :SEARCh:RUNT:POLarity

**Syntax** :SEARCh:RUNT:POLarity <polarity>  
:SEARCh:RUNT:POLarity?

**Description** Sets or queries the polarity for "Runt" search type.

| Parameter | Name       | Type     | Range               | Default  |
|-----------|------------|----------|---------------------|----------|
|           | <polarity> | Discrete | {POSitive NEGative} | POSitive |

**Return Format** The query returns POS or NEG.

**Example** :SEARCh:RUNT:POLarity NEGative /\*Sets the polarity of "Runt" search type to NEGative.\*/  
:SEARCh:RUNT:POLarity? /\*The query returns NEG.\*/\*

## :SEARCh:RUNT:QUALifier

**Syntax** :SEARCh:RUNT:QUALifier <qualifier>  
:SEARCh:RUNT:QUALifier?

**Description** Sets or queries the search condition for "Runt" search type.

| Parameter | Name        | Type     | Range                      | Default |
|-----------|-------------|----------|----------------------------|---------|
|           | <qualifier> | Discrete | {NONE GREater LESS GLESSs} | GREater |

**Remarks** ➤ NONE: indicates not setting the trigger condition of Runt trigger.

- GREater: triggers when the runt pulse width is greater than the lower limit of pulse width.
- LESS: triggers when the runt pulse width is smaller than the upper limit of pulse width.
- GLESS: triggers when the runt pulse width is greater than the lower limit and smaller than the upper limit of pulse width. Note: The lower limit of the pulse width must be smaller than the upper limit.

**Return Format** The query returns NONE, GRE, LESS, or GLES.

**Example** :SEARch:RUNT:QUALifier LESS /\*Sets the search condition for "Runt" search type to LESS.\*/  
:SEARch:RUNT:QUALifier? /\*The query returns LESS.\*/

## :SEARch:RUNT:SOURce

**Syntax** :SEARch:RUNT:SOURce <source>  
:SEARch:RUNT:SOURce?

**Description** Sets or queries the source for "Runt" search type.

| Parameter | Name     | Type     | Range                                 | Default  |
|-----------|----------|----------|---------------------------------------|----------|
|           | <source> | Discrete | {CHANnel1 CHANnel2 CHANnel3 CHANnel4} | CHANnel1 |

**Return Format** The query returns CHAN1, CHAN2, CHAN3, or CHAN4.

**Example** :SEARch:RUNT:SOURce CHANnel1 /\*Sets the source to CHANnel1.\*/  
:SEARch:RUNT:SOURce? /\*The query returns CHAN1.\*/

## :SEARch:SLOPe:POLarity

**Syntax** :SEARch:SLOPe:POLarity <polarity>  
:SEARch:SLOPe:POLarity?

**Description** Sets or queries the edge type for "Slope" search type.

| Parameter | Name       | Type     | Range               | Default  |
|-----------|------------|----------|---------------------|----------|
|           | <polarity> | Discrete | {POSitive NEGative} | POSitive |

**Return Format** The query returns POS or NEG.

**Example** :SEARch:SLOPe:POLarity NEGative /\*Sets the edge typ of "Slope" search type to NEGative.\*/  
:SEARch:SLOPe:POLarity? /\*The query returns NEG.\*/

**:SEARCh:SLOPe:QUALifier**

**Syntax** :SEARCh:SLOPe:QUALifier <qualifier>

:SEARCh:SLOPe:QUALifier?

**Description** Sets or queries the search condition for "Slope" search type.

| Parameter | Name        | Type     | Range                | Default |
|-----------|-------------|----------|----------------------|---------|
|           | <qualifier> | Discrete | {GREater LESS GLESS} | GREater |

- Remarks**
- GREater: the positive slope time of the input signal is greater than the specified time.
  - LESS: the positive slope time of the input signal is smaller than the specified time.
  - GLESS: the positive slope time of the input signal is greater than the specified lower limit of time and smaller than the specified upper limit of time.

**Return Format** The query returns GRE, LESS, or GLEs.

**Example** :SEARCh:SLOPe:QUALifier LESS /\*Sets the search condition for "Slope" search type to LESS.\*/  
:SEARCh:SLOPe:QUALifier? /\*The query returns LESS.\*/\*

**:SEARCh:SLOPe:SOURce**

**Syntax** :SEARCh:SLOPe:SOURce <source>

:SEARCh:SLOPe:SOURce?

**Description** Sets or queries the source for "Slope" search type.

| Parameter | Name     | Type     | Range                                 | Default  |
|-----------|----------|----------|---------------------------------------|----------|
|           | <source> | Discrete | {CHANnel1 CHANnel2 CHANnel3 CHANnel4} | CHANnel1 |

**Return Format** The query returns CHAN1, CHAN2, CHAN3, or CHAN4.

**Example** :SEARCh:SLOPe:SOURce CHANnel1 /\*Sets the source to CHANnel1.\*/  
:SEARCh:SLOPe:SOURce? /\*The query returns CHAN1.\*/\*

## [:SOURce[<n>]] Commands

The [:SOURce[<n>]] commands are used to set the relevant parameters of the built-in function/arbitrary waveform generator. <n> can be set to 1 or 2, which indicates the corresponding built-in function/arbitrary waveform generator channel. When <n> or :SOURce[<n>] is omitted, by default, the operations are carried out on AWG GI. The commands are only available for the model installed with the MSO8000-AWG option.

### Command List:

- ◆ [\[:SOURce\[<n>\]\]:FREQuency\[:FIXed\]](#)
- ◆ [\[:SOURce\[<n>\]\]:PHASe\[:ADJust\]](#)
- ◆ [\[:SOURce\[<n>\]\]:PHASe:INITiate](#)
- ◆ [\[:SOURce\[<n>\]\]:FUNCTion\[:SHAPE\]](#)
- ◆ [\[:SOURce\[<n>\]\]:FUNCTion:RAMP:SYMMetry](#)
- ◆ [\[:SOURce\[<n>\]\]:VOLTagE\[:LEVel\]\[:IMMediate\]\[:AMPLitude\]](#)
- ◆ [\[:SOURce\[<n>\]\]:VOLTagE\[:LEVel\]\[:IMMediate\]:OFFSet](#)
- ◆ [\[:SOURce\[<n>\]\]:PULSe:DCYCLE](#)
- ◆ [\[:SOURce\[<n>\]\]:TYPE](#)
- ◆ [\[:SOURce\[<n>\]\]:MOD:TYPE](#)
- ◆ [\[:SOURce\[<n>\]\]:MOD:AM\[:DEPTH\]](#)
- ◆ [\[:SOURce\[<n>\]\]:MOD:AM:INTernal:FREQuency](#)
- ◆ [\[:SOURce\[<n>\]\]:MOD:FM:INTernal:FREQuency](#)
- ◆ [\[:SOURce\[<n>\]\]:MOD:AM:INTernal:FUNCTion](#)
- ◆ [\[:SOURce\[<n>\]\]:MOD:FM:INTernal:FUNCTion](#)
- ◆ [\[:SOURce\[<n>\]\]:MOD:FM\[:DEVIation\]](#)
- ◆ [\[:SOURce\[<n>\]\]:SWEp:TYPE](#)
- ◆ [\[:SOURce\[<n>\]\]:SWEp:STIME](#)
- ◆ [\[:SOURce\[<n>\]\]:SWEp:BTIME](#)
- ◆ [\[:SOURce\[<n>\]\]:BURSt:TYPE](#)
- ◆ [\[:SOURce\[<n>\]\]:BURSt:CYCLes](#)
- ◆ [\[:SOURce\[<n>\]\]:BURSt:DELay](#)
- ◆ [\[:SOURce\[<n>\]\]:APPLY?](#)
- ◆ [\[:SOURce\[<n>\]\]:APPLY:NOISe](#)
- ◆ [\[:SOURce\[<n>\]\]:APPLY:PULSe](#)
- ◆ [\[:SOURce\[<n>\]\]:APPLY:RAMP](#)
- ◆ [\[:SOURce\[<n>\]\]:APPLY:SINusoid](#)
- ◆ [\[:SOURce\[<n>\]\]:APPLY:SQUare](#)
- ◆ [\[:SOURce\[<n>\]\]:APPLY:USER](#)
- ◆ [\[:SOURce\[<n>\]\]:OUTPut\[<n>\]:STATe\]](#)
- ◆ [\[:SOURce\[<n>\]\]:OUTPut\[<n>\]:IMPedance](#)



## [[:SOURce[<n>]]:FREQuency[:FIXed]

**Syntax** [:SOURce[<n>]]:FREQuency[:FIXed] <frequency>

[:SOURce[<n>]]:FREQuency[:FIXed]?

**Description** If modulation is not enabled for the specified function/arbitrary waveform generator channel, this command is used to set or query the output frequency of the specified function/arbitrary waveform generator channel. If modulation is enabled for the specified function/arbitrary waveform generator channel, this command is used to set or query the carrier frequency of the specified function/arbitrary waveform generator channel. By default, the unit is Hz.

| Parameter | Name        | Type     | Range                                                                                                                                 | Default                                                         |
|-----------|-------------|----------|---------------------------------------------------------------------------------------------------------------------------------------|-----------------------------------------------------------------|
|           | [<n>]       | Discrete | {1 2}                                                                                                                                 | When omitted, by default, the operations are carried out on G1. |
|           | <frequency> | Real     | Sine: 100 mHz to 25 MHz<br>Square: 100 mHz to 15 MHz<br>Pulse: 100 mHz to 1 MHz<br>Ramp: 100 mHz to 100 kHz<br>Arb: 100 mHz to 10 MHz | 1 kHz                                                           |

**Return Format** The query returns the frequency value in scientific notation. For example 2.0000000E+5.

**Example** :FREQuency 1000 /\*Sets the output frequency of G1 to 1 kHz.\*/  
:FREQuency? /\*The query returns 1.000000E+3.\*/

## [[:SOURce[<n>]]:PHASe[:ADJust]

**Syntax** [:SOURce[<n>]]:PHASe[:ADJust] <phase>

[:SOURce[<n>]]:PHASe[:ADJust]?

**Description** Sets or queries the start phase of the signal of the specified function/arbitrary waveform generator channel. By default, the unit is °.

| Parameter | Name    | Type     | Range    | Default                                                         |
|-----------|---------|----------|----------|-----------------------------------------------------------------|
|           | [<n>]   | Discrete | {1 2}    | When omitted, by default, the operations are carried out on G1. |
|           | <phase> | Real     | 0 to 360 | 0                                                               |

**Return Format** The query returns the start phase in scientific notation.

**Example** :PHASe 90 /\*Sets the start phase of G1 to 90°.\*/  
:PHASe? /\*The query returns 9.000000E+1.\*/

## [:SOURce[<n>]]:PHASe:INITiate

**Syntax** [:SOURce[<n>]]:PHASe:INITiate

**Description** Performs the "align phase" operation.

| Parameter | Name  | Type     | Range | Default                                                         |
|-----------|-------|----------|-------|-----------------------------------------------------------------|
|           | [<n>] | Discrete | {1 2} | When omitted, by default, the operations are carried out on G1. |

**Remarks** When you perform the "align phase" operation, the instrument will re-configure the two channels to output according to the preset frequency and phase.

For two signals whose frequencies are the same or in multiple relationship, this operation can align their phases. Assume that 1 kHz, 5 Vpp, 0° sine waveforms are output on G1, and 1 kHz, 5Vpp, 180° sine waveforms are output on GII. Use the oscilloscope to acquire the waveforms of the two channels and stably display the waveforms. It can be found that the phase deviation between the two waveforms is no longer 180°. At this time, perform the "align phase" operations and then the waveforms have a phase deviation of 180°. You do not need to adjust the start phase of the function/arbitrary waveform generator manually.

## [:SOURce[<n>]]:FUNction[:SHAPe]

**Syntax** [:SOURce[<n>]]:FUNction[:SHAPe] <wave>

[:SOURce[<n>]]:FUNction[:SHAPe]?

**Description** If modulation is not enabled for the specified function/arbitrary waveform generator channel, this command is used to select or query the output signal waveform. If modulation is enabled for the specified function/arbitrary waveform generator channel, this command is used to select or query the modulated carrier waveform. At this time, if you select PULSe, NOISe, or DC, the modulation function is automatically disabled.

| Parameter | Name   | Type     | Range                                                                                            | Default                                                         |
|-----------|--------|----------|--------------------------------------------------------------------------------------------------|-----------------------------------------------------------------|
|           | [<n>]  | Discrete | {1 2}                                                                                            | When omitted, by default, the operations are carried out on G1. |
|           | <wave> | Discrete | {SINusoid SQUare RAMP PULSe NOISe DC SINC EXPRise EXPFall ECG GAUSS LORentz HAVersine ARbitrary} | SINusoid                                                        |

**Remarks** The MSO8000 series provides 7 kinds of built-in waveforms, including Sinc, ExpRise, ExpFall, ECG, Gauss, Lorentz, and Haversine.

**Return Format** The query returns SIN, SQU, RAMP, PULS, NOIS, DC, SINC, EXPR, EXPF, ECG, GAUS, LOR, HAV, or ARB.

**Example** :FUNction SQUare /\*Sets the waveforms output from G1 to SQUare.\*/  
:FUNction? /\*The query returns SQU.\*/\*

## [[:SOURce[<n>]]:FUNction:RAMP:SYMMetry

**Syntax** [[:SOURce[<n>]]:FUNction:RAMP:SYMMetry <val>

[[:SOURce[<n>]]:FUNction:RAMP:SYMMetry?

**Description** Sets or queries the symmetry of the Ramp waveforms output from the specified function/arbitrary waveform generator channel.

| Parameter | Name  | Type     | Range    | Default                                                         |
|-----------|-------|----------|----------|-----------------------------------------------------------------|
|           | [<n>] | Discrete | {1 2}    | When omitted, by default, the operations are carried out on GI. |
|           | <val> | Real     | 1 to 100 | 10                                                              |

**Remarks** Symmetry is defined as the percentage that the rising period of the ramp takes up in the whole period.

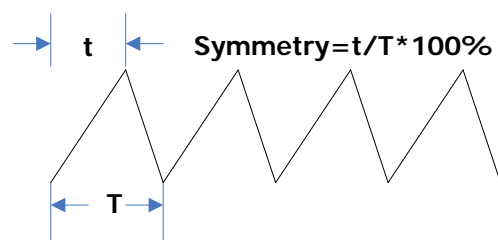

**Return Format** The query returns the current symmetry in scientific notation.

**Example** :FUNction:RAMP:SYMMetry 50 /\*Sets the symmetry of Ramp waveform output from GI to 50%.\*/

:FUNction:RAMP:SYMMetry? /\*The query returns 5.000000E+1.\*/

## [[:SOURce[<n>]]:VOLTage[:LEVel][:IMMediate][:AMPLitude]

**Syntax** [[:SOURce[<n>]]:VOLTage[:LEVel][:IMMediate][:AMPLitude] <amplitude>

[[:SOURce[<n>]]:VOLTage[:LEVel][:IMMediate][:AMPLitude]?

**Description** Sets or queries the amplitude of the signal output from the specified function/arbitrary waveform generator channel. By default, the unit is Vpp.

| Parameter | Name        | Type     | Range                                                                                         | Default                                                         |
|-----------|-------------|----------|-----------------------------------------------------------------------------------------------|-----------------------------------------------------------------|
|           | [<n>]       | Discrete | {1 2}                                                                                         | When omitted, by default, the operations are carried out on GI. |
|           | <amplitude> | Real     | Related to the current output impedance<br>HighZ: 20 mVpp to 5 Vpp<br>50Ω: 10 mVpp to 2.5 Vpp | 5 Vpp                                                           |

**Remarks** Send the [\[:SOURce\[<n>\]\]:OUTPut\[<n>\]:IMPedance](#) command to set the input impedance.

**Return Format** The query returns the amplitude value in scientific notation.

**Example** :VOLTage 2 /\*Sets the output amplitude of GI to 2 V.\*/  
:VOLTage? /\*The query returns 2.000000E0.\*/

## [:SOURce[<n>]]:VOLTage[:LEVel][:IMMediate]:OFFSet

**Syntax** [:SOURce[<n>]]:VOLTage[:LEVel] [:IMMediate]:OFFSet <offset>

[:SOURce[<n>]]:VOLTage[:LEVel] [:IMMediate]:OFFSet?

**Description** Sets or queries the DC offset of the signal output from the specified function/arbitrary waveform generator channel. By default, the unit is  $V_{DC}$ .

**Parameter**

| Name     | Type     | Range                                                                                                                                                                                                     | Default                                                         |
|----------|----------|-----------------------------------------------------------------------------------------------------------------------------------------------------------------------------------------------------------|-----------------------------------------------------------------|
| [<n>]    | Discrete | {1 2}                                                                                                                                                                                                     | When omitted, by default, the operations are carried out on GI. |
| <offset> | Real     | Related to the current output impedance and amplitude<br>HighZ: (-2.5 V + current amplitude/2) to (2.5 V - current amplitude/2)<br>50Ω: (-1.25 V + current amplitude/2) to (1.25 V - current amplitude/2) | 0 $V_{DC}$                                                      |

- Remarks**
- Send the [\[:SOURce\[<n>\]\]:OUTPut\[<n>\]:IMPedance](#) command to set the input impedance.
  - Send the [\[:SOURce\[<n>\]\]:VOLTage\[:LEVel\]\[:IMMediate\]\[:AMPLitude\]](#) command to set the current amplitude.

**Return Format** The query returns the DC offset in scientific notation.

**Example** :VOLTage:OFFSet 0.5 /\*Sets the DC offset of GI to 500 mV<sub>DC</sub>.\*/  
:VOLTage:OFFSet? /\*The query returns 5.0000000E-1.\*/

## [:SOURce[<n>]]:PULSe:DCYCLE

**Syntax** [:SOURce[<n>]]:PULSe:DCYCLE <percent>

[:SOURce[<n>]]:PULSe:DCYCLE?

**Description** Sets or queries the duty cycle of the pulse output from the specified function/arbitrary waveform generator channel, i.g. the ratio of high level to a pulse period.

**Parameter**

| Name      | Type     | Range    | Default                                                         |
|-----------|----------|----------|-----------------------------------------------------------------|
| [<n>]     | Discrete | {1 2}    | When omitted, by default, the operations are carried out on GI. |
| <percent> | Real     | 10 to 90 | 20                                                              |

**Remarks** Duty cycle is defined as the percentage that the high level takes up in the whole pulse period.

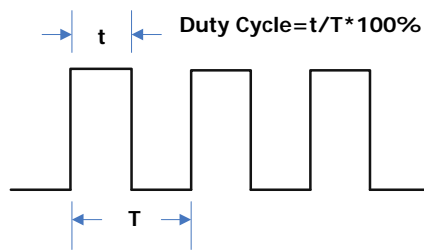

**Return Format** The query returns the current duty cycle in scientific notation.

**Example** :PULSe:DCYClE 50 /\*Sets the duty cycle of GI pulse to 50%.\*/  
:PULSe:DCYClE? /\*The query returns 5.000000E+1.\*/

## [[:SOURce[<n>]]:TYPE

**Syntax** [:SOURce[<n>]]:TYPE <type>  
[:SOURce[<n>]]:TYPE?

**Description** Sets or queries the signal source type of the specified function/arbitrary waveform generator channel.

| Parameter | Name   | Type     | Range                  | Default                                                         |
|-----------|--------|----------|------------------------|-----------------------------------------------------------------|
|           | [<n>]  | Discrete | {1 2}                  | When omitted, by default, the operations are carried out on GI. |
|           | <type> | Discrete | {NONE MOD SWEep BURst} | SWEep                                                           |

**Return Format** The query returns NONE, MOD, SWEep, or BURst.

**Example** :TYPE MOD /\*Sets the signal source type of GI to MOD.\*/  
:TYPE? /\*The query returns MOD.\*/

## [[:SOURce[<n>]]:MOD:TYPE

**Syntax** [:SOURce[<n>]]:MOD:TYPE <type>  
[:SOURce[<n>]]:MOD:TYPE?

**Description** Sets or queries the modulation type of the specified function/arbitrary waveform generator channel.

| Parameter | Name   | Type     | Range       | Default                                                         |
|-----------|--------|----------|-------------|-----------------------------------------------------------------|
|           | [<n>]  | Discrete | {1 2}       | When omitted, by default, the operations are carried out on GI. |
|           | <type> | Discrete | {AM FM FSK} | AM                                                              |

- Remarks**
- AM: Amplitude Modulation. The amplitude of the carrier waveform changes with the amplitude of the modulating waveform.
  - FM: Frequency Modulation. The frequency of the carrier waveform changes with the the modulating waveform.
  - FSK: Frequency-shift Keying Modulation. Control the carrier frequency changes with the digital signal.
  - The Sine, Square, Ramp, Built-in Waveform, or Non-DC signal's arbitrary waveforms can be regarded as carrier waveforms.

- You can select Sine, Square, Triangle, or Noise as the modulating waveforms.

**Return Format** The query returns AM, FM, or FSK.

**Example** :MOD:TYPE AM /\*Sets the modulation type of GI to AM.\*/  
:MOD:TYPE? /\*The query returns AM.\*/

## **[[:SOURce[<n>]]:MOD:AM[:DEPT]h]**

**Syntax** [:SOURce[<n>]]:MOD:AM[:DEPT]h <depth>  
[:SOURce[<n>]]:MOD:AM[:DEPT]h?

**Description** Sets or queries the depth of AM of the specified function/arbitrary waveform generator channel. The modulation depth refers to the strength of the AM and is expressed in percentage.

| Parameter | Name    | Type     | Range      | Default                                                         |
|-----------|---------|----------|------------|-----------------------------------------------------------------|
|           | [<n>]   | Discrete | {1 2}      | When omitted, by default, the operations are carried out on GI. |
|           | <depth> | Integer  | 0% to 120% | 100%                                                            |

- Remarks**
- When the modulation depth is 0%, the output amplitude is half of the amplitude of the carrier signal.
  - When the modulation depth is 100%, the output amplitude is equal to the amplitude of the carrier signal.
  - When the modulation depth is greater than 100%, envelop distortion will occur. This should be avoided in actual circuit. At this time, the output of the instrument will not exceed 5 Vpp (the load is 50 Ω).

**Return Format** The query returns an integer ranging from 0 to 120.

**Example** :MOD:AM 80 /\*Sets the AM modulation depth of GI to 80%.\*/  
:MOD:AM? /\*The query returns 80.\*/

## **[[:SOURce[<n>]]:MOD:AM:INTernal:FREQuency** **[[:SOURce[<n>]]:MOD:FM:INTernal:FREQuency**

**Syntax** [:SOURce[<n>]]:MOD:AM:INTernal:FREQuency <frequency>  
[:SOURce[<n>]]:MOD:AM:INTernal:FREQuency?  
[:SOURce[<n>]]:MOD:FM:INTernal:FREQuency <frequency>  
[:SOURce[<n>]]:MOD:FM:INTernal:FREQuency?

**Description** Sets or queries the modulating waveform frequency of AM or FM of the specified function/arbitrary waveform generator channel. The default unit is Hz.

| Parameter | Name        | Type     | Range          | Default                                                         |
|-----------|-------------|----------|----------------|-----------------------------------------------------------------|
|           | [<n>]       | Discrete | {1 2}          | When omitted, by default, the operations are carried out on GI. |
|           | <frequency> | Integer  | 1 Hz to 50 kHz | 1 kHz                                                           |

- Remarks** ➤ You can send the [\[:SOURce\[<n>\]\]:MOD:TYPE](#) command to set the modulation type.

- AM: Amplitude Modulation. The amplitude of the carrier waveform changes with the amplitude of the modulating waveform.  
FM: Frequency Modulation. The frequency of the carrier waveform changes with the modulating waveform.
- You can select Sine, Square, Triangle, or Noise as the modulating waveforms.

**Return Format** The query returns the modulating waveform frequency in scientific notation.

**Example** :MOD:AM:INTernal:FREQuency 100 /\*Sets the modulating waveform frequency of AM of GI to 100 Hz.\*/  
:MOD:AM:INTernal:FREQuency? /\*The query returns 1.000000E+2.\*/

## **[:SOURce[<n>]]:MOD:AM:INTernal:FUNCTion** **[:SOURce[<n>]]:MOD:FM:INTernal:FUNCTion**

**Syntax** [:SOURce[<n>]]:MOD:AM:INTernal:FUNCTion <wave>  
[:SOURce[<n>]]:MOD:AM:INTernal:FUNCTion?  
[:SOURce[<n>]]:MOD:FM:INTernal:FUNCTion <wave>  
[:SOURce[<n>]]:MOD:FM:INTernal:FUNCTion?

**Description** Sets or queries the modulating waveform of AM or FM of the specified function/arbitrary waveform generator channel.

**Parameter**

| Name   | Type     | Range                        | Default                                                         |
|--------|----------|------------------------------|-----------------------------------------------------------------|
| [<n>]  | Discrete | {1 2}                        | When omitted, by default, the operations are carried out on GI. |
| <wave> | Discrete | {SINusoid SQUare RAMP NOISe} | SINusoid                                                        |

- Remarks**
- You can select SINusoid (Sine), SQUare (Square), RAMP (Ramp), or NOISe (Noise) as the modulating waveforms. Send the [\[:SOURce\[<n>\]\]:MOD:AM:INTernal:FREQuency](#) or [\[:SOURce\[<n>\]\]:MOD:FM:INTernal:FREQuency](#) command to set the frequency of the selected modulating waveforms.
  - You can send the [\[:SOURce\[<n>\]\]:MOD:TYPE](#) command to set the modulation type.
  - AM: Amplitude Modulation. The amplitude of the carrier waveform changes with the amplitude of the modulating waveform.  
FM: Frequency Modulation. The frequency of the carrier waveform changes with the modulating waveform.

**Return Format** The query returns SIN, SQU, RAMP, or NOIS.

**Example** :MOD:AM:INTernal:FUNCTion SQUare /\*Sets the modulating waveforms of AM of GI to SQUare.\*/  
:MOD:AM:INTernal:FUNCTion? /\*The query returns SQU.\*/

## [:SOURce[<n>]]:MOD:FM[:DEVIation]

**Syntax** [:SOURce[<n>]]:MOD:FM[:DEVIation] <dev>

[:SOURce[<n>]]:MOD:FM[:DEVIation]?

**Description** Sets or queries the frequency offset of FM of the specified function/arbitrary waveform generator channel. By default, the unit is Hz.

| Parameter | Name  | Type     | Range                                       | Default                                                         |
|-----------|-------|----------|---------------------------------------------|-----------------------------------------------------------------|
|           | [<n>] | Discrete | {1 2}                                       | When omitted, by default, the operations are carried out on GI. |
|           | <dev> | Real     | 1 Hz to the currently set carrier frequency | 1 kHz                                                           |

- Remarks**
- Send the [:SOURce[<n>]]:FREQuency:FIXed command to set the carrier frequency, and send the [:SOURce[<n>]]:MOD:FM:INTernal:FREQuency command to set the FM frequency.
  - When the modulating waveform amplitude reaches the maximum value, the frequency of the carrier is increased by "frequency offset". When the modulating waveform amplitude reaches the minimum value, the frequency of the carrier is decreased by "frequency offset".
  - Only when FM is selected for the specified function/arbitrary waveform generator channel, can the frequency offset of FM be set.

**Return Format** The query returns the frequency offset in scientific notation.

**Example** :MOD:FM 100 /\*Sets the frequency offset of FM of GI to 100 Hz.\*/  
:MOD:FM? /\*The query returns 1.000000E+2.\*/

## [:SOURce[<n>]]:SWEep:TYPE

**Syntax** [:SOURce[<n>]]:SWEep:TYPE <type>

[:SOURce[<n>]]:SWEep:TYPE?

**Description** Sets or queries the sweep type of the specified signal source channel.

| Parameter | Name   | Type     | Range             | Default                                                         |
|-----------|--------|----------|-------------------|-----------------------------------------------------------------|
|           | [<n>]  | Discrete | {1 2}             | When omitted, by default, the operations are carried out on GI. |
|           | <type> | Discrete | {LINear LOG STEP} | LINear                                                          |

- Remarks**
- LINear: the frequency of the signal changes linearly.
  - LOG: the frequency of the signal changes in log form.
  - STEP: the frequency of the signal changes with ladder-like step.

**Return Format** The query returns LIN, LOG, or STEP.

**Example** :SWEep:TYPE LOG /\*Sets the sweep type of GI to LOG.\*/  
:SWEep:TYPE? /\*The query returns LOG.\*/



**[[:SOURce[<n>]]:SWEep:STIME**

**Syntax** [:SOURce[<n>]]:SWEep:STIME <time>

[:SOURce[<n>]]:SWEep:STIME?

**Description** Sets or queries the sweep time of the specified signal source channel.

| Parameter | Name   | Type     | Range         | Default                                                         |
|-----------|--------|----------|---------------|-----------------------------------------------------------------|
|           | [<n>]  | Discrete | {1 2}         | When omitted, by default, the operations are carried out on GI. |
|           | <time> | Integer  | 1 ms to 500 s | 1 s                                                             |

**Remarks** After modifying the sweep time, the function/arbitrary waveform generator will restart to output from the specified "Start Freq".

**Return Format** The query returns an integer ranging from 1 ms to 500 s.

**Example** :SWEep:STIME 30 /\*Sets the sweep time of GI to 30 s.\*/  
:SWEep:STIME? /\*The query returns 30.\*/

**[[:SOURce[<n>]]:SWEep:BTIME**

**Syntax** [:SOURce[<n>]]:SWEep:BTIME <time>

[:SOURce[<n>]]:SWEep:BTIME?

**Description** Sets or queries the return time of the specified signal source channel.

| Parameter | Name   | Type     | Range        | Default                                                         |
|-----------|--------|----------|--------------|-----------------------------------------------------------------|
|           | [<n>]  | Discrete | {1 2}        | When omitted, by default, the operations are carried out on GI. |
|           | <time> | Integer  | 0 s to 500 s | 0 s                                                             |

**Remarks** Return time indicates the time that the output signal restores from "End Freq" to "Start Freq" after the Function/Arbitrary Waveform Generator sweeps from "Start Freq" to "End Freq" and the "End Keep" time expires.

**Return Format** The query returns an integer ranging from 0 s to 500 s.

**Example** :SWEep:BTIME 30 /\*Sets the return time of GI to 30 s.\*/  
:SWEep:BTIME? /\*The query returns 30.\*/

**[[:SOURce[<n>]]:BURSt:TYPE**

**Syntax** [:SOURce[<n>]]:BURSt:TYPE <type>

[:SOURce[<n>]]:BURSt:TYPE?

**Description** Sets or queries the burst type of the specified signal source channel.

| Parameter | Name   | Type     | Range             | Default                                                         |
|-----------|--------|----------|-------------------|-----------------------------------------------------------------|
|           | [<n>]  | Discrete | {1 2}             | When omitted, by default, the operations are carried out on GI. |
|           | <type> | Discrete | {NCYCLe INFinite} | NCYCLe                                                          |

**Remarks** ➤ NCYCLe: outputs the burst waveforms with a specified number of cycles once

receiving the trigger signal.

- INFinite: sets the number of cycles to Infinite. It outputs continuous waveforms once receiving the trigger signal.

**Return Format** The query returns NCYC or INF.

**Example** :BURSt:TYPE INFinite /\*Sets the burst type of GI to INFinite.\*/  
:BURSt:TYPE? /\*The query returns INF.\*/\*

## [[:SOURce[<n>]]:BURSt:CYCLes

**Syntax** [:SOURce[<n>]]:BURSt:CYCLes <count>  
[:SOURce[<n>]]:BURSt:CYCLes?

**Description** Sets or queries the number of burst cycles of the specified signal source channel.

| Parameter | Name    | Type     | Range   | Default                                                         |
|-----------|---------|----------|---------|-----------------------------------------------------------------|
|           | [<n>]   | Discrete | {1 2}   | When omitted, by default, the operations are carried out on GI. |
|           | <count> | Integer  | 1 to 10 | 1                                                               |

**Remarks** This command is invalid when the burst type is "Infinite".

**Return Format** The query returns an integer ranging from 1 to 10.

**Example** :BURSt:CYCLes 3 /\*Sets the burst cycles of GI to 3.\*/  
:BURSt:CYCLes? /\*The query returns 3.\*/\*

## [[:SOURce[<n>]]:BURSt:DELay

**Syntax** [:SOURce[<n>]]:BURSt:DELay <time>  
[:SOURce[<n>]]:BURSt:DELay?

**Description** Sets or queries the burst delay time of the specified signal source channel.

| Parameter | Name   | Type     | Range                   | Default                                                         |
|-----------|--------|----------|-------------------------|-----------------------------------------------------------------|
|           | [<n>]  | Discrete | {1 2}                   | When omitted, by default, the operations are carried out on GI. |
|           | <time> | Integer  | Refer to <b>Remarks</b> | 0 s                                                             |

- Remarks**
- Burst delay indicates the time from when receiving the trigger signal to starting to output N Cycle of bursts or Infinite burst.
  - The available range of the delay time is related to the burst cycles.

**Return Format** The query returns an integer.

**Example** :BURSt:DELay 3 /\*Sets the burst delay time of GI to 3 s.\*/  
:BURSt:DELay? /\*The query returns 3.\*/\*

**[[:SOURce[<n>]]:APPLY?****Syntax** [:SOURce[<n>]]:APPLY?**Description** Queries the current output configuration of the specified function/arbitrary waveform generator channel.

| Parameter | Name  | Type     | Range | Default                                                         |
|-----------|-------|----------|-------|-----------------------------------------------------------------|
|           | [<n>] | Discrete | {1 2} | When omitted, by default, the operations are carried out on GI. |

**Return Format** The query returns the current output configuration in "<waveform name>,<frequency>,<amplitude>,<offset>,<start phase>" format. If no corresponding parameter is found, DEF is replaced with the specified parameter value.**Example** :APPLY? /\*The query returns SIN,1000.000000,2.000000,0.500000,90.000000.\*/\***[[:SOURce[<n>]]:APPLY:NOISe****[[:SOURce[<n>]]:APPLY:PULSe****[[:SOURce[<n>]]:APPLY:RAMP****[[:SOURce[<n>]]:APPLY:SINusoid****[[:SOURce[<n>]]:APPLY:SQUare****[[:SOURce[<n>]]:APPLY:USER****Syntax** [:SOURce[<n>]]:APPLY:NOISe [<amp>[,<offset>]]

[:SOURce[&lt;n&gt;]]:APPLY:PULSe [&lt;freq&gt;[,&lt;amp&gt;[,&lt;offset&gt;[,&lt;phase&gt;]]]]

[:SOURce[&lt;n&gt;]]:APPLY:RAMP [&lt;freq&gt;[,&lt;amp&gt;[,&lt;offset&gt;[,&lt;phase&gt;]]]]

[:SOURce[&lt;n&gt;]]:APPLY:SINusoid [&lt;freq&gt;[,&lt;amp&gt;[,&lt;offset&gt;[,&lt;phase&gt;]]]]

[:SOURce[&lt;n&gt;]]:APPLY:SQUare [&lt;freq&gt;[,&lt;amp&gt;[,&lt;offset&gt;[,&lt;phase&gt;]]]]

[:SOURce[&lt;n&gt;]]:APPLY:USER [&lt;freq&gt;[,&lt;amp&gt;[,&lt;offset&gt;[,&lt;phase&gt;]]]]

**Description** Configures the specified function/arbitrary waveform generator channel to output the signal with the specified waveforms and parameters.

| Parameter | Name   | Type     | Range                                                                                                                            | Default                                                         |
|-----------|--------|----------|----------------------------------------------------------------------------------------------------------------------------------|-----------------------------------------------------------------|
|           | [<n>]  | Discrete | {1 2}                                                                                                                            | When omitted, by default, the operations are carried out on GI. |
|           | <freq> | Real     | Sine: 0.1 Hz to 25 MHz<br>Square: 0.1 Hz to 15 MHz<br>Pulse: 0.1 Hz to 1 MHz<br>Ramp: 0.1 Hz to 100 kHz<br>Arb: 0.1 Hz to 10 MHz | 1 kHz                                                           |
|           | <amp>  | Real     | Related to the currently set output impedance<br>HighZ: 20 mVpp to 5 Vpp<br>50Ω: 10 mVpp to 2.5 Vpp                              | 5 Vpp                                                           |

|          |      |                                                                                                                                                                                                           |                   |
|----------|------|-----------------------------------------------------------------------------------------------------------------------------------------------------------------------------------------------------------|-------------------|
| <offset> | Real | Related to the current output impedance and amplitude<br>HighZ: (-2.5 V + current amplitude/2) to (2.5 V - current amplitude/2)<br>50Ω: (-1.25 V + current amplitude/2) to (1.25 V - current amplitude/2) | 0 V <sub>DC</sub> |
| <phase>  | Real | 0° to 360°                                                                                                                                                                                                | 0°                |

- Remarks**
- This series of commands are used to select the waveform shape.  
NOISe: noise  
PULSe: pulse  
RAMP: ramp waveform  
SINusoid: sine waveform  
SQUare: square waveform  
ARBitrary: arbitrary waveform
  - <freq>: sets the frequency of the specified waveform (this parameter is not available for Noise waveform). By default, the unit is Hz.  
<amp>: sets the amplitude of the specified waveform. By default, the unit is V<sub>pp</sub>.  
<offset>: sets the DC offset of the specified waveform. By default, the unit is V<sub>DC</sub>.  
<phase>: sets the start phase of the specified waveform (this parameter is not available for Noise waveform). By default, the unit is degree (°).
  - This series of commands allow users to omit one or multiple parameters. When all the parameters are omitted, the commands only configure the specified function/arbitrary waveform generator channel to the specified waveform, without modifying the corresponding parameters.
  - The four parameters <freq>, <amp>, <offset>, and <phase> should be appeared in sequence. In the command, the parameters are configured in sequence, and you are not allowed to set the latter parameter without setting the former one. For example, you cannot set the parameter <amp> directly by omitting the parameter <freq>.

### [:SOURce[<n>]]:OUTPut[<n>][:STATe]

**Syntax** [:SOURce[<n>]]:OUTPut[<n>][:STATe] <bool>  
[:SOURce[<n>]]:OUTPut[<n>][:STATe]?

**Description** Enables or disables the output of the specified function/arbitrary waveform generator channel; or queries the output status of the specified function/arbitrary waveform generator channel.

| Parameter | Name   | Type     | Range            | Default                                                         |
|-----------|--------|----------|------------------|-----------------------------------------------------------------|
|           | [<n>]  | Discrete | {1 2}            | When omitted, by default, the operations are carried out on G1. |
|           | <bool> | Bool     | {{1 ON} {0 OFF}} | 0 OFF                                                           |

**Remarks** The [:SOURce[<n>]] and :OUTPut[<n>] are used to specify the channel of the function/arbitrary waveform generator. The former has a high priority over the latter. That is, when the former is omitted, the latter is used to specify the channel; when the former is not omitted, the former is used to specify the channel.

**Return Format** The query returns 0 or 1.

**Example** :OUTPut ON /\*Enables the output of GI.\*/  
 :OUTPut? /\*The query returns 1.\*/

## [:SOURce[<n>]]:OUTPut[<n>]:IMPedance

**Syntax** [:SOURce[<n>]]:OUTPut[<n>]:IMPedance <impedance>  
 [:SOURce[<n>]]:OUTPut[<n>]:IMPedance?

**Description** Sets or queries the impedance of the specified function/arbitrary waveform generator channel.

| Parameter | Name        | Type     | Range        | Default                                                         |
|-----------|-------------|----------|--------------|-----------------------------------------------------------------|
|           | [<n>]       | Discrete | {1 2}        | When omitted, by default, the operations are carried out on GI. |
|           | <impedance> | Discrete | {OMEG FIFTy} | OMEG                                                            |

**Remarks** OMEG: indicates HighZ; FIFTy: indicates 50Ω.

**Return Format** The query returns OMEG or FIFT.

**Example** :OUTPut:IMPedance FIFTy /\*Sets the output impedance of GI to FIFTy.\*/  
 :OUTPut:IMPedance? /\*The query returns FIFT.\*/

## :SYSTem Commands

The :SYSTem commands are used to set sound, language, and other relevant system settings.

### Command List:

- ◆ [:SYSTem:AOUTput](#)
- ◆ [:SYSTem:AUTClear](#)
- ◆ [:SYSTem:AUToscale](#)
- ◆ [:SYSTem:BEEPer](#)
- ◆ [:SYSTem:DATE](#)
- ◆ [:SYSTem:ERRor\[:NEXT\]?](#)
- ◆ [:SYSTem:GAMount?](#)
- ◆ [:SYSTem:RCLock](#)
- ◆ [:SYSTem:GPIB](#)
- ◆ [:SYSTem:KEY:PREsS](#)
- ◆ [:SYSTem:KEY:INCRease](#)
- ◆ [:SYSTem:KEY:DECRease](#)
- ◆ [:SYSTem:LANGuage](#)
- ◆ [:SYSTem:PON](#)
- ◆ [:SYSTem:PSTatus](#)
- ◆ [:SYSTem:OPTion:INSTall](#)
- ◆ [:SYSTem:OPTion:UNINSTall](#)
- ◆ [:SYSTem:OPTion:STATus?](#)
- ◆ [:SYSTem:PWDClear](#)
- ◆ [:SYSTem:RAMount?](#)
- ◆ [:SYSTem:RESet](#)
- ◆ [:SYSTem:SETup](#)
- ◆ [:SYSTem:SSAVEr:TIME](#)
- ◆ [:SYSTem:TIME](#)
- ◆ [:SYSTem:LOCKed](#)
- ◆ [:SYSTem:MODules?](#)

## :SYSTem:AOUTput

**Syntax** :SYSTem:AOUTput <aux output>

:SYSTem:AOUTput?

**Description** Sets or queries the type of the signal output from the **[TRIG OUT]** connector on the rear panel.

| Parameter | Name         | Type     | Range        | Default |
|-----------|--------------|----------|--------------|---------|
|           | <aux output> | Discrete | {TOUT PFAil} | TOUT    |

- Remarks**
- TOUT: after you select this type, the oscilloscope initiates a trigger and then a signal which reflects the current capture rate of the oscilloscope can be output from the **[TRIG OUT]** connector.
  - PFAil: after you select this type, a pulse signal will be output from the **[TRIG OUT]** connector once the oscilloscope detects a successful or failed event.

**Return Format** The query returns TOUT or PFA.

**Example** :SYSTem:AOUTput PFAil /\*Sets the signal type to PFAil.\*/  
:SYSTem:AOUTput? /\*The query returns PFA.\*/\*

## :SYSTem:AUTClear

**Syntax** :SYSTem:AUTClear

**Description** Restores the default password for AUTO lock (the default password is none).

## :SYSTem:AUToscale

**Syntax** :SYSTem:AUToscale <bool>

:SYSTem:AUToscale?

**Description** Enables or disables the function of the front-panel **AUTO** key; or queries the on/off status of the **AUTO** key on the front panel.

| Parameter | Name   | Type | Range            | Default |
|-----------|--------|------|------------------|---------|
|           | <bool> | Bool | {{1 ON} {0 OFF}} | 1 ON    |

- Remarks**
- You can send this command or use the menu key to disable the function of the **AUTO** key.
  - After the function of the **AUTO** key is disabled, you cannot perform the Auto Scale operation. The :AUToscale command is invalid.

**Return Format** The query returns 1 or 0.

**Example** :SYSTem:AUToscale ON /\*Enables the function of the front-panel **AUTO** key.\*/  
:SYSTem:AUToscale? /\*The query returns 1.\*/\*

**:SYSTem:BEEPer**

**Syntax** :SYSTem:BEEPer <bool>

:SYSTem:BEEPer?

**Description** Turns on or off the beeper; or queries the on/off status of the beeper.

**Parameter**

| Name       | Type | Range            | Default |
|------------|------|------------------|---------|
| <bool<br>> | Bool | {{1 ON} {0 OFF}} | 0 OFF   |

**Return Format** The query returns 1 or 0.

**Example** :SYSTem:BEEPer ON /\*Enables the beeper.\*/  
:SYSTem:BEEPer? /\*The query returns 1.\*/\*

**:SYSTem:DATE**

**Syntax** :SYSTem:DATE <year>,<month>,<day>.

:SYSTem:DATE?

**Description** Sets or queries the system date.

**Parameter**

| Name    | Type    | Range                   | Default |
|---------|---------|-------------------------|---------|
| <year>  | Integer | 2017 to 2099            | ---     |
| <month> | Integer | 1 to 12                 | ---     |
| <day>   | Integer | 1 to 31 (28, 29, or 30) | ---     |

**Return Format** The query returns the system date in strings. The year, month, and date are separated by commas.

**Example** :SYSTem:DATE 2017,10,17 /\*Sets the system date to 2017/10/17.\*/  
:SYSTem:DATE? /\*The query returns 2017,10,17.\*/\*

**:SYSTem:ERRor[:NEXT]?**

**Syntax** :SYSTem:ERRor[:NEXT]?

**Description** Queries and clears the latest error message.

**Return Format** The query is in <Message Number>,<Message Content> format. Wherein, <Message Number> is an integer and <Message Content> is a double-quoted ASCII string. For example, -113,"Undefined header; command cannot be found".

**:SYSTem:GAMount?**

**Syntax** :SYSTem:GAMount?

**Description** Queries the number of grids in the horizontal direction of the screen.

**Return Format** The query returns the number of grids in integer. For this oscilloscope, the query returns a fixed value 10.



**:SYSTem:RCLock**

**Syntax** :SYSTem:RCLock <clock>

:SYSTem:RCLock?

**Description** Sets or queries the type of the reference clock.

| Parameter | Name    | Type     | Range                | Default |
|-----------|---------|----------|----------------------|---------|
|           | <clock> | Discrete | {COUtput CINPut OFF} | OFF     |

- Remarks**
- COUtput: indicates the clock output. The instrument outputs the internal 10 MHz clock signal from the rear-panel **[10M In/Out]** connector.
  - CINPut: indicates the clock input. The oscilloscope receives the external 10 MHz signal as the clock signal from the rear-panel **[10M In/Out]** connector.
  - OFF: disables the reference clock function.

**Return Format** The query returns COU, CINP, or OFF.

**Example** :SYSTem:RCLock CINPut           /\*Sets the type of the reference clock to CINPut.\*/  
:SYSTem:RCLock?                   /\*The query returns CINP.\*/\*

**:SYSTem:GPIB**

**Syntax** :SYSTem:GPIB <adr>

:SYSTem:GPIB?

**Description** Sets or queries the GPIB address.

| Parameter | Name  | Type    | Range   | Default |
|-----------|-------|---------|---------|---------|
|           | <adr> | Integer | 1 to 30 | 1       |

**Return Format** The query returns an integer ranging from 1 to 30.

**Example** :SYSTem:GPIB 2               /\*Sets the GPIB address to 2.\*/  
:SYSTem:GPIB?                   /\*The query returns 2.\*/\*

**:SYSTem:KEY:PRESS**

**Syntax** :SYSTem:KEY:PRESS <key>

**Description** Press down the specified key on the front panel of the oscilloscope.

| Parameter | Name  | Type     | Range                                                                                                                                                                                                                                                                                                                                                         | Default |
|-----------|-------|----------|---------------------------------------------------------------------------------------------------------------------------------------------------------------------------------------------------------------------------------------------------------------------------------------------------------------------------------------------------------------|---------|
|           | <key> | Discrete | {CH1 CH2 CH3 CH4 MATH REF LA DECode M OFF F1 F2 F3 F4 F5 F6 F7 NPRevious NNEXT NSTop VOFFset1 VOFFset2 VOFFset3 VOFFset4 VSCale1 VSCale2 VSCale3 VSCale4 HSCale HPOSITION KFUNCTION TLEVel TMODE DEFAulT CLEar AUTO RSTop SINGle QUICK MEASure A CQuire STORage CURSor DISPlay UTILity FO Rce GENerator1 GENerator2 BACK TOUCh ZO OM SEARCh WScale WPOSITION} | ---     |

**Remarks** The value of the parameter <key> corresponds to the specified key on the front panel.

The definitions for the key are as follows:

- CH1|CH2|CH3|CH4|MATH|REF|LA|DECode|DEFault|CLEAr|AUTO|SINGle|QUICK|M EASure|ACQuire|STORage|CURSor|DISPlay|UTILity|FORCe|BACK|TOUCH|ZOOM|S EARCh: press the specified key on the front panel.
- MOFF: hides or display the menu at the right side of the screen.
- F1|F2|F3|F4|F5|F6|F7: press the 7 menu softkeys at the right side of the screen.
- NPRevious|NNEXT|NSTop: press the navigation key.
- VOFFset1: press down the CH1 vertical offset knob, i.g. sets the vertical offset of CH1 to 0.
- VOFFset2: press down the CH2 vertical offset knob, i.g. sets the vertical offset of CH2 to 0.
- VOFFset3: press down the CH3 vertical offset knob, i.g. sets the vertical offset of CH3 to 0.
- VOFFset4: press down the CH4 vertical offset knob, i.g. sets the vertical offset of CH4 to 0.
- VSCale1: press down the vertical scale knob of CH1, i.g. switch the vertical scale of CH1 to "Coarse" or "Fine".
- VSCale2: press down the vertical scale knob of CH2, i.g. switch the vertical scale of CH2 to "Coarse" or "Fine".
- VSCale3: press down the vertical scale knob of CH3, i.g. switch the vertical scale of CH3 to "Coarse" or "Fine".
- VSCale4: press down the vertical scale knob of CH4, i.g. switch the vertical scale of CH4 to "Coarse" or "Fine".
- WSCale: press down the vertical scale knob in the waveform control area.
- WPOsition: press down the vertical position knob in the waveform control area.
- GENerator1|GENerator2: press down AWG1 or AWG2.
- HSCale: press down the horizontal time base adjustment knob, i.g. switch the horizontal time base to "Coarse" or "Fine".
- HPOsition: press down the horizontal position knob, i.g. set the horizontal position to 0.
- KFUNction: press down the multifunction knob.
- TLEVel: press down the trigger level adjustment knob, i.g. set the trigger level to 50% of the peak-peak value.
- TMENu: press the **MENU** key in the trigger control area.
- TMODe: press the **MODE** key in the trigger control area.
- RSTop: press the **RUN/STOP** key.

**Example** :SYSTem:KEY:PRESS <CH1> /\*Press the CH1 key on the front panel of the oscilloscope.\*/

## :SYSTem:KEY:INCRease

## :SYSTem:KEY:DECRease

**Syntax** :SYSTem:KEY:INCRease <key>[,<val>]  
:SYSTem:KEY:DECRease <key>[,<val>]

**Description** Rotate the specified knob clockwise.

Rotate the specified knob counterclockwise.

### Parameter

| Name  | Type     | Range                                                                                                                   | Default |
|-------|----------|-------------------------------------------------------------------------------------------------------------------------|---------|
| <key> | Discrete | {VOFFset1 VOFFset2 VOFFset3 VOFFset4 VSCale1 VSCale2 VSCale3 VSCale4 HSCale HPOSITION KFUNction TLEVel WVOLT WPOSITION} | ---     |
| <val> | Integer  | Determined by the range of the parameter <key> and the current setting of the parameter.                                | 1       |

- Remarks**
- The value of the parameter <key> corresponds to the specified knob on the front panel. The definitions for the knob are as follows:  
VOFFset1: the CH1 vertical offset knob.  
VOFFset2: the CH2 vertical offset knob.  
VOFFset3: the CH3 vertical offset knob.  
VOFFset4: the CH4 vertical offset knob.  
VSCale1: the vertical scale adjustment knob of CH1.  
VSCale2: the vertical scale adjustment knob of CH2.  
VSCale3: the vertical scale adjustment knob of CH3.  
VSCale4: the vertical scale adjustment knob of CH4.  
HSCale: the horizontal time base adjustment knob.  
HPOSITION: the horizontal position adjustment knob.  
KFUNction: the multifunction knob.  
TLEVel: the trigger level adjustment knob.  
WVOLT: the vertical scale adjustment knob for the waveform.  
WPOSITION: the vertical position adjustment knob for the waveform.
  - The parameter <val> defines the specified rotation times of the knob. By default, it is 1.

**Example** :SYSTem:KEY:INCRease VOFFset2 /\*Rotates the vertical offset adjustment knob of CH2 clockwise.\*/

## :SYSTem:LANGUage

**Syntax** :SYSTem:LANGUage <language>  
:SYSTem:LANGUage?

**Description** Sets or queries the system language.

### Parameter

| Name       | Type     | Range                                                                                                     | Default  |
|------------|----------|-----------------------------------------------------------------------------------------------------------|----------|
| <language> | Discrete | {SCHinese TCHinese KORean JAPanese ENGLISH GERMan PORTuguese POLish FRE Nch RUSSian SPAN THAI INDonesian} | SCHinese |

**Remarks** The language settings are not affected by factory default settings (send the [\\*RST](#) command).

**Return Format** The query returns SCH, TCH, KOR, JAP, ENGL, GERM, PORT, POL, FREN, RUSS, SPAN, THAI, or IND.

**Example** :SYSTem:LANGUage ENGLISH /\*Sets the system language to ENGLISH.\*/  
:SYSTem:LANGUage? /\*The query returns ENGL.\*/

**:SYSTem:PON**

**Syntax** :SYSTem:PON <power on>

:SYSTem:PON?

**Description** Sets or queries the configuration type recalled by the oscilloscope when it is powered on again after power-off.

| Parameter | Name            | Type     | Range            | Default |
|-----------|-----------------|----------|------------------|---------|
|           | < power<br>on > | Discrete | {LATest DEFault} | DEFault |

**Return Format** The query returns LAT or DEF.

**Example** :SYSTem:PON LATest /\*Sets the oscilloscope to recall Last value after it is powered on again.\*/

:SYSTem:PON? /\*The query returns LAT.\*/

**:SYSTem:PSTatus**

**Syntax** :SYSTem:PSTatus <sat>

:SYSTem:PSTatus?

**Description** Sets or queries the power status of the oscilloscope.

| Parameter | Name  | Type     | Range          | Default |
|-----------|-------|----------|----------------|---------|
|           | <sat> | Discrete | {DEFault OPEN} | OPEN    |

- Remarks**
- DEFault: after the oscilloscope is powered on, you need to press the Power key on the front panel to start the oscilloscope.
  - OPEN: after the oscilloscope is powered on, it starts directly. You do not have to press the Power key.

**Return Format** The query returns DEF or OPEN.

**Example** :SYSTem:PSTatus DEFault /\*Sets the power status to DEFault.\*/

:SYSTem:PSTatus? /\*The query returns DEF.\*/

**:SYSTem:OPTion:INSTall**

**Syntax** :SYSTem:OPTion:INSTall <license>

**Description** Installs an option.

| Parameter | Name      | Type         | Range                   | Default |
|-----------|-----------|--------------|-------------------------|---------|
|           | <license> | ASCII String | Refer to <b>Remarks</b> | ---     |

- Remarks**
- To install the option, first purchase the required option to obtain the key, and then use the key to obtain the option license according to the following steps.
    - Log in to the **RIGOL** official website (www.rigol.com), click **License Activation** to enter the "Registered product license code" interface.
    - In the interface, enter the correct key, serial number (press **Utility** → **System** → **About** to obtain the serial number of the instrument. You can also open the

"Help" function menu, and then press **About** to obtain the serial number), and the verification code. Click **Generate** to obtain the download link of the option license file. If you need to use the option license file, click to download the file to the specified directory of the USB storage device.

- The license is a fixed length of strings. Each instrument has a unique license.

**Example** :SYSTem:OPTion:INSTall

```
MSO8000-DG@A7DEC6C1E10D42EE8E3AF0728C3D272F507E646EB54B9C97E6CCBA9
8468A46A863FED814C24D47B8B40C894B1822660B94852E6778392281A20B54B4E72
3E3FD
```

## :SYSTem:OPTion:UNINStall

**Syntax** :SYSTem:OPTion:UNINStall

**Description** Uninstalls all the official options.

**Remarks** After the option has been uninstalled, you need to restart the instrument.

## :SYSTem:OPTion:STATus?

**Syntax** :SYSTem:OPTion:STATus? <type>

**Description** Queries the status of the options of the oscilloscope.

| Parameter | Name | Type     | Range                                                                     | Default |
|-----------|------|----------|---------------------------------------------------------------------------|---------|
| <type>    |      | Discrete | {BW6T10 BW6T20 BW10T20 BND COMP EMBD AUTO FLEX AUDIO AERO AWG PWR JITTER} | ---     |

**Remarks** BW6T10: bandwidth upgrade option. The bandwidth upgrades from 600 MHz to 1GHz.

BW6T20: bandwidth upgrade option. The bandwidth upgrades from 600 MHz to 2GHz.

BW10T20: bandwidth upgrade option. The bandwidth upgrades from 1 GHz to 2 GHz.

BND: function and application bundle option, MSO8000-COMP, MSO8000-EMBD, MSO8000-AUTO, MSO8000-FLEX, MSO8000-AUDIO, MSO8000-AERO, MSO8000-AWG, MSO8000-PWR, and MSO8000-JITTER.

COMP: PC serial bus trigger and analysis option (RS232/UART).

EMBD: embedded serial bus trigger and analysis option (I2C and SPI).

AUTO: auto serial bus trigger and analysis option (CAN and LIN).

FLEX: FlexRay serial bus trigger and analysis option (FlexRay).

AUDIO: audio serial bus trigger and analysis option (I2S).

AERO: MIL-STD-1553 serial bus trigger and analysis option (MIL-STD-1553).

AWG: dual-channel 25 MHz Arbitrary Waveform Generator.

PWR: built-in power analysis option.

JITTER: real-time eye diagram and jitter analysis option.

**Return** The query returns 0 or 1.

**Format** 0: indicates that the option is not installed.

1: indicates that the official option has been installed.

**:SYSTem:PWDClear**

**Syntax** :SYSTem:PWDClear

**Description** Restores the default password for web control (the default password is rigol).

**:SYSTem:RAMount?**

**Syntax** :SYSTem:RAMount?

**Description** Queries the number of analog channels of the current instrument.

**Return Format** The query returns the number of analog channels of the current instrument in integer. For this oscilloscope, the query returns a fixed value 4.

**:SYSTem:RESet**

**Syntax** :SYSTem:RESet

**Description** Resets the system to power on again.

**:SYSTem:SEtUp**

**Syntax** :SYSTem:SEtUp <setup\_data>

:SYSTem:SEtUp?

**Description** Sends or reads the data stream of the system setup file.

| Parameter | Name         | Type         | Range                            | Default |
|-----------|--------------|--------------|----------------------------------|---------|
|           | <setup_data> | ASCII String | Refer to <a href="#">Remarks</a> | ---     |

- Remarks**
- <setup\_data> is a binary data block, which consists of the TMC data block header and setup data.
    - The format of the TMC data block header is **#NX...X**. Wherein, **#** is the start identifier of the data stream; the N-digit data "X...X" (**N≤9**) following the start identifier indicate the length of the data stream (the number of bytes). For example, **#9000002506**. Wherein, **N** is **9**, **000002506** following it represents that the data stream contains 2506 bytes of effective data.
    - The setup data are expressed in ASCII format.
  - When sending the command, directly place the data stream after the command string, then complete the whole sending process in one time. When reading the data stream, ensure that there is enough buffer space to receive the data stream; otherwise, errors might occur in reading the program.

**:SYSTem:SSAVer:TIME**

**Syntax** :SYSTem:SSAVer:TIME <time>

:SYSTem:SSAVer:TIME?

**Description** Sets or queries the screen saver time. The default unit for the value is minute.

| Parameter | Name   | Type    | Range    | Default |
|-----------|--------|---------|----------|---------|
|           | <time> | Integer | 1 to 999 | 30      |

**Remarks** When the oscilloscope enters the idle state and holds for a specified time, the screen

saver program will be enabled.

**Return Format** The query returns an integer ranging from 1 to 999.

**Example** :SYSTem:SSAVEr:TIME 10 /\*Sets the screen saver time to 10 minutes.\*/  
:SYSTem:SSAVEr:TIME? /\*The query returns 10.\*/\*

## :SYSTem:TIME

**Syntax** :SYSTem:TIME <hours>,<minutes>,<seconds>  
:SYSTem:TIME?

**Description** Sets or queries the system time.

| Parameter | Name      | Type    | Range   | Default |
|-----------|-----------|---------|---------|---------|
|           | <hours>   | Integer | 0 to 23 | ---     |
|           | <minutes> | Integer | 0 to 59 | ---     |
|           | <seconds> | Integer | 0 to 59 | ---     |

**Remarks** There is a certain delay between the return time value and the set time value due to the command response time and other factors.

**Return Format** The query returns the system time in strings.

**Example** :SYSTem:TIME 16,10,17 /\*Sets the system time to 16:10:17.\*/  
:SYSTem:TIME? /\*The query returns 16,10,17\*/\*

## :SYSTem:LOCKed

**Syntax** :SYSTem:LOCKed <bool>  
:SYSTem:LOCKed?

**Description** Turns on or off the keyboard lock function; or queries whether the keyboard is locked or unlocked.

| Parameter | Name   | Type | Range              | Default |
|-----------|--------|------|--------------------|---------|
|           | <bool> | Bool | {{1 ON}} {{0 OFF}} | 0 OFF   |

**Return Format** The query returns 1 or 0.

**Example** :SYSTem:LOCKed ON /\*Enables the keyboard lock function.\*/  
:SYSTem:LOCKed? /\*The query returns 1.\*/\*

## :SYSTem:MODules?

**Syntax** :SYSTem:MODules?

**Description** Queries the hardware modules.

**Return Format** The query returns 1,0,0,0,0. The first figure indicates LA; the second figure indicates DG; and the others are not defined currently. 1 indicates not null, and 0 indicates null.

## :TIMebase Commands

The :TIMebase commands are used to set the horizontal system. For example, enable the delayed sweep, set the horizontal time base mode, etc.

### Command List:

- ◆ [:TIMebase:DELAy:ENABle](#)
- ◆ [:TIMebase:DELAy:OFFSet](#)
- ◆ [:TIMebase:DELAy:SCALe](#)
- ◆ [:TIMebase\[:MAIN\]:OFFSet](#)
- ◆ [:TIMebase\[:MAIN\]:SCALe](#)
- ◆ [:TIMebase:MODE](#)
- ◆ [:TIMebase:HREFerence:MODE](#)
- ◆ [:TIMebase:HREFerence:POSition](#)
- ◆ [:TIMebase:VERNier](#)

### :TIMebase:DELAy:ENABle

**Syntax** :TIMebase:DELAy:ENABle <bool>

:TIMebase:DELAy:ENABle?

**Description** Turns on or off the delayed sweep; or queries the on/off status of the delayed sweep.

| Parameter | Name   | Type | Range              | Default |
|-----------|--------|------|--------------------|---------|
|           | <bool> | Bool | {{1 ON}} {{0 OFF}} | 0 OFF   |

**Remarks** Delayed sweep can be used to enlarge a length of waveform horizontally to view waveform details.

**Return Format** The query returns 1 or 0.

**Example** :TIMebase:DELAy:ENABle ON /\*Enables the delayed sweep.\*/  
:TIMebase:DELAy:ENABle? /\*The query returns 1.\*/\*

### :TIMebase:DELAy:OFFSet

**Syntax** :TIMebase:DELAy:OFFSet <offset>

:TIMebase:DELAy:OFFSet?

**Description** Sets or queries the offset of the delayed time base. The default unit is s.

| Parameter | Name          | Type | Range                                                    | Default |
|-----------|---------------|------|----------------------------------------------------------|---------|
|           | <offset><br>> | Real | -(LeftTime - DelayRange/2) to (RightTime - DelayRange/2) | 0       |

**Remarks** LeftTime = 5 × MainScale - MainOffset  
RightTime = 5 × MainScale + MainOffset  
DelayRange = 10 × DelayScale  
Wherein, MainScale indicates the current main time base scale, MainOffset indicates the current main time base offset, and DelayScale indicates the current delay time base



scale.

**Return Format** The query returns the offset of the delayed time base in scientific notation.

**Example** :TIMEbase:DELay:OFFSet 0.000002 /\*Sets the offset of the delayed time base to 2  $\mu$ s.\*/

:TIMEbase:DELay:OFFSet? /\*The query returns 2.000000E-6.\*/

## :TIMEbase:DELay:SCALE

**Syntax** :TIMEbase:DELay:SCALE <scale>

:TIMEbase:DELay:SCALE?

**Description** Sets or queries the scale of the delayed time base. The default unit is s/div.

| Parameter | Name    | Type | Range                   | Default    |
|-----------|---------|------|-------------------------|------------|
|           | <scale> | Real | Refer to <b>Remarks</b> | 500 ns/div |

- Remarks**
- The maximum value of the parameter <scale> is the current main time base scale, and the minimum value is 50/(current sample rate × magnification times).
  - The delayed time base scale can only be the maximum value or the values acquired by reducing from the maximum value at 1-2-5 step. If the minimum value calculated from the above formula is not one of the settable values, take the minimum settable value that is greater than the minimum value calculated.

**Return Format** The query returns the delayed time base scale in scientific notation.

**Example** :TIMEbase:DELay:SCALE 0.00000005 /\*Sets the delayed time base scale to 50 ns/div.\*/

:TIMEbase:DELay:SCALE? /\*The query returns 5.000000E-8.\*/

## :TIMEbase[:MAIN]:OFFSet

**Syntax** :TIMEbase[:MAIN]:OFFSet <offset>

:TIMEbase[:MAIN]:OFFSet?

**Description** Sets or queries the offset of the main time base. The default unit is s.

| Parameter | Name     | Type | Range                   | Default |
|-----------|----------|------|-------------------------|---------|
|           | <offset> | Real | Refer to <b>Remarks</b> | 0       |

**Remarks** The range of <offset> is related to the current horizontal time base mode and the operating status of the oscilloscope.

**Return Format** The query returns the offset of the main time base in scientific notation.

**Example** :TIMEbase:MAIN:OFFSet 0.0002 /\*Sets the offset of the main time base to 200  $\mu$ s.\*/

:TIMEbase:MAIN:OFFSet? /\*The query returns 2.000000E-4.\*/

**:TIMebase[:MAIN]:SCALE**

**Syntax** :TIMebase[:MAIN]:SCALE <scale>

:TIMebase[:MAIN]:SCALE?

**Description** Sets or queries the scale of the main time base.

| Parameter | Name    | Type | Range                   | Default       |
|-----------|---------|------|-------------------------|---------------|
|           | <scale> | Real | Refer to <b>Remarks</b> | 1 $\mu$ s/div |

**Remarks** The range of <scale> is related to the current horizontal time base mode of the oscilloscope and its model.

- YT mode  
5 ns to 1,000 s  
2 ns to 1,000 s (when upgrading the bandwidth to 2 G)
- Roll mode  
200 ms to 1,000 s

**Return Format** The query returns the main time base scale in scientific notation.

**Example** :TIMebase:MAIN:SCALE 0.0002 /\*Sets the main time base scale to 200  $\mu$ s/div.\*/  
:TIMebase:MAIN:SCALE? /\*The query returns 2.000000E-4.\*/

**:TIMebase:MODE**

**Syntax** :TIMebase:MODE <mode>

:TIMebase:MODE?

**Description** Sets or queries the horizontal time base mode.

| Parameter | Name   | Type     | Range          | Default |
|-----------|--------|----------|----------------|---------|
|           | <mode> | Discrete | {MAIN XY ROLL} | MAIN    |

- Remarks**
- MAIN: indicates the YT mode.
  - XY: indicates the XY mode.
  - ROLL: indicates the Roll mode.

**Return Format** The query returns MAIN, XY, or ROLL.

**Example** :TIMebase:MODE XY /\*Sets the horizontal time base mode to XY.\*/  
:TIMebase:MODE? /\*The query returns XY.\*/

**:TIMebase:HREFerence:MODE**

**Syntax** :TIMebase:HREFerence:MODE <href>

:TIMebase:HREFerence:MODE?

**Description** Sets or queries the horizontal reference mode.

| Parameter | Name   | Type     | Range                    | Default |
|-----------|--------|----------|--------------------------|---------|
|           | <href> | Discrete | {CENTer LB RB TRIG USER} | CENTer  |

- Remarks**
- CENTER: when the horizontal time base is modified, the waveform displayed will be expanded or compressed horizontally relative to the screen center.
  - LB: when the horizontal time base is modified, the waveform displayed will be expanded or compressed relative to the left border of the screen.

- RB: when the horizontal time base is modified, the waveform displayed will be expanded or compressed relative to the right border of the screen.
- TRIG: when the horizontal time base is modified, the waveform displayed will be expanded or compressed horizontally relative to the trigger position.
- USER: when the horizontal time base is modified, the waveform displayed will be expanded or compressed horizontally relative to the user-defined reference position.

**Return Format** The query returns CENT, LB, RB, TRIG, or USER.

**Example** :TIMEbase:HREFerence:MODE TRIG /\*Sets the horizontal reference mode to trigger position.\*/  
:TIMEbase:HREFerence:MODE? /\*The query returns TRIG.\*/\*

## :TIMEbase:HREFerence:POSition

**Syntax** :TIMEbase:HREFerence:POSition <pos>  
:TIMEbase:HREFerence:POSition?

**Description** Sets or queries the user-defined reference position when the waveforms are expanded or compressed horizontally.

| Parameter | Name  | Type     | Range       | Default |
|-----------|-------|----------|-------------|---------|
|           | <pos> | Discrete | -500 to 500 | 0       |

**Return Format** The query returns an integer ranging from -500 to 500.

**Example** :TIMEbase:HREFerence:POSition 60/\*Sets the user-defined reference position to 60.\*/  
:TIMEbase:HREFerence:POSition? /\*The query returns 60.\*/\*

## :TIMEbase:VERNier

**Syntax** :TIMEbase:VERNier <bool>  
:TIMEbase:VERNier?

**Description** Enables or disables the fine adjustment function of the horizontal scale; or queries the on/off status of the fine adjustment function of the horizontal scale.

| Parameter | Name   | Type     | Range              | Default |
|-----------|--------|----------|--------------------|---------|
|           | <bool> | Discrete | {{1 ON}} {{0 OFF}} | 0 OFF   |

**Return Format** The query returns 1 or 0.

**Example** :TIMEbase:VERNier ON /\*Sets the fine adjustment function of the horizontal scale to ON .\*/  
:TIMEbase:VERNier? /\*The query returns 1.\*/\*

## :TRIGger Commands

The :TRIGger commands are used to set the trigger system of the oscilloscope.

### Command List:

- ◆ [:TRIGger:MODE](#)
- ◆ [:TRIGger:COUPling](#)
- ◆ [:TRIGger:STATus?](#)
- ◆ [:TRIGger:SWEEp](#)
- ◆ [:TRIGger:HOLDoff](#)
- ◆ [:TRIGger:NREJect](#)
- ◆ [:TRIGger:EDGE](#)
- ◆ [:TRIGger:PULSe](#)
- ◆ [:TRIGger:SLOPe](#)
- ◆ [:TRIGger:VIDeo](#)
- ◆ [:TRIGger:PATtern](#)
- ◆ [:TRIGger:DUration](#)
- ◆ [:TRIGger:TIMEout](#)
- ◆ [:TRIGger:RUNT](#)
- ◆ [:TRIGger:WINDows](#)
- ◆ [:TRIGger:DElay](#)
- ◆ [:TRIGger:SHOLD](#)
- ◆ [:TRIGger:NEDGE](#)
- ◆ [:TRIGger:RS232 \(Option\)](#)
- ◆ [:TRIGger:IIC \(Option\)](#)
- ◆ [:TRIGger:CAN \(Option\)](#)
- ◆ [:TRIGger:SPI \(Option\)](#)
- ◆ [:TRIGger:FLEXray \(Option\)](#)
- ◆ [:TRIGger:IIS \(Option\)](#)
- ◆ [:TRIGger:LIN \(Option\)](#)
- ◆ [:TRIGger:M1553 \(Option\)](#)

**:TRIGger:MODE**

**Syntax** :TRIGger:MODE <mode>

:TRIGger:MODE?

**Description** Selects or queries the trigger type.

| Parameter | Name   | Type     | Range                                                                                                                   | Default |
|-----------|--------|----------|-------------------------------------------------------------------------------------------------------------------------|---------|
|           | <mode> | Discrete | {EDGE PULSe SLOPe VIDeo PATTern DURation TIMeout RUNT WINDow DELay SETup NEDGe RS232 IIC SPI CAN FLEXray LIN IIS M1553} | EDGE    |

**Return Format** The query returns EDGE, PULS, SLOP, VID, PATT, DUR, TIM, RUNT, WIND, DEL, SET, NEDG, RS232, IIC, SPI, CAN, FLEX, LIN, IIS, or M1553.

**Example** :TRIGger:MODE SLOPe /\*Selects the Slope trigger.\*/  
:TRIGger:MODE? /\*The query returns SLOP.\*/\*

**:TRIGger:COUPLing**

**Syntax** :TRIGger:COUPLing <couple>

:TRIGger:COUPLing?

**Description** Selects or queries the trigger coupling type.

| Parameter | Name     | Type     | Range                     | Default |
|-----------|----------|----------|---------------------------|---------|
|           | <couple> | Discrete | {AC DC LFReject HFReject} | DC      |

- Remarks**
- This command is only available for the Edge trigger in which the analog channel is selected as the source.
  - AC: blocks any DC components.
  - DC: allows DC and AC components to pass the trigger path.
  - LFReject: blocks the DC components and rejects the low frequency components.
  - HFReject: rejects the high frequency components.

**Return Format** The query returns AC, DC, LFR, or HFR.

**Example** :TRIGger:COUPLing LFReject /\*Sets the trigger coupling type to low frequency rejection.\*/  
:TRIGger:COUPLing? /\*The query returns LFR.\*/\*

**:TRIGger:STATus?**

**Syntax** :TRIGger:STATus?

**Description** Queries the current trigger status.

**Return Format** The query returns TD, WAIT, RUN, AUTO, or STOP.

## :TRIGger:SWEep

**Syntax** :TRIGger:SWEep <sweep>

:TRIGger:SWEep?

**Description** Sets or queries the trigger mode.

| Parameter | Name    | Type     | Range                | Default |
|-----------|---------|----------|----------------------|---------|
|           | <sweep> | Discrete | {AUTO NORMal SINGle} | AUTO    |

- Remarks**
- AUTO: Auto trigger. The waveforms are displayed no matter whether the trigger conditions are met.
  - NORMal: normal trigger. The waveforms are displayed when trigger conditions are met. If the trigger conditions are not met, the oscilloscope displays the original waveforms and waits for another trigger.
  - SINGle: single trigger. The oscilloscope waits for a trigger, displays the waveforms when the trigger conditions are met, and then stops.

**Return Format** The query returns AUTO, NORM, or SING.

**Example** :TRIGger:SWEep SINGle /\*Selects the single trigger mode.\*/  
:TRIGger:SWEep? /\*The query returns SING.\*/

## :TRIGger:HOLDoff

**Syntax** :TRIGger:HOLDoff <value>

:TRIGger:HOLDoff?

**Description** Sets or queries the trigger holdoff time. The default unit is s.

| Parameter | Name    | Type | Range         | Default |
|-----------|---------|------|---------------|---------|
|           | <value> | Real | 16 ns to 10 s | 16 ns   |

- Remarks**
- Trigger holdoff can be used to stably trigger complex waveforms (such as pulse waveform). Holdoff time indicates the time that the oscilloscope waits for re-arming the trigger module. The oscilloscope will not trigger before the holdoff time expires.
  - Holdoff time is not available for Video trigger, Timeout trigger, Setup&Hold trigger, Nth Edge trigger, RS232 trigger, I2C trigger, SPI trigger, CAN trigger, FlexRay trigger, LIN trigger, I2S trigger, or 1553B trigger.

**Return Format** The query returns the trigger holdoff time in scientific notation.

**Example** :TRIGger:HOLDoff 0.0000002 /\*Sets the trigger holdoff time to 200 ns.\*/  
:TRIGger:HOLDoff? /\*The query returns 2.000000E-7.\*/

**:TRIGger:NREJect**

**Syntax** :TRIGger:NREJect <bool>

:TRIGger:NREJect?

**Description** Turns on or off noise rejection; or queries the on/off status of noise rejection.

| Parameter | Name   | Type | Range              | Default |
|-----------|--------|------|--------------------|---------|
|           | <bool> | Bool | {{1 ON}} {{0 OFF}} | 0 OFF   |

- Remarks**
- Noise rejection reduces the possibility of the Noise trigger.
  - This command is only available for the External trigger in which the analog channel is selected as the source.

**Return Format** The query returns 1 or 0.

**Example** :TRIGger:NREJect ON /\*Enables the noise rejection function.\*/  
:TRIGger:NREJect? /\*The query returns 1.\*/\*

**:TRIGger:EDGE****Command List:**

- ◆ [:TRIGger:EDGE:SOURce](#)
- ◆ [:TRIGger:EDGE:SLOPe](#)
- ◆ [:TRIGger:EDGE:LEVel](#)

**:TRIGger:EDGE:SOURce**

**Syntax** :TRIGger:EDGE:SOURce <source>

:TRIGger:EDGE:SOURce?

**Description** Sets or queries the trigger source of Edge trigger.

| Parameter | Name     | Type     | Range                                                                                                  | Default  |
|-----------|----------|----------|--------------------------------------------------------------------------------------------------------|----------|
|           | <source> | Discrete | {D0 D1 D2 D3 D4 D5 D6 D7 D8 D9 D10 D11 D12 D13 D14 D15 CHANnel1 CHANnel2 CHANnel3 CHANnel4 ACLine EXT} | CHANnel1 |

**Return Format** The query returns D0, D1, D2, D3, D4, D5, D6, D7, D8, D9, D10, D11, D12, D13, D14, D15, CHAN1, CHAN2, CHAN3, CHAN4, ACL, or EXT.

**Example** :TRIGger:EDGE:SOURce CHANnel1 /\*Sets the trigger source to CHANnel1.\*/  
:TRIGger:EDGE:SOURce? /\*The query returns CHAN1.\*/\*

**:TRIGger:EDGE:SLOPe**

**Syntax** :TRIGger:EDGE:SLOPe <slope>

:TRIGger:EDGE:SLOPe?

**Description** Sets or queries the edge type of Edge trigger.

| Parameter | Name    | Type     | Range                     | Default  |
|-----------|---------|----------|---------------------------|----------|
|           | <slope> | Discrete | {POSitive NEGative RFALI} | POSitive |

- Remarks**
- POSitive: indicates the rising edge.
  - NEGative: indicates the falling edge.
  - RFALI: indicates the rising or falling edge.

**Return Format** The query returns POS, NEG, or RFAL.

**Example** :TRIGger:EDGE:SLOPe Negative /\*Sets the edge type to NEGative.\*/  
:TRIGger:EDGE:SLOPe? /\*The query returns NEG.\*/\*

**:TRIGger:EDGE:LEVel**

**Syntax** :TRIGger:EDGE:LEVel <level>

:TRIGger:EDGE:LEVel?

**Description** Sets or queries the trigger level of Edge trigger. The unit is the same as that of current amplitude of the selected source.

| Parameter | Name    | Type | Range                                                            | Default |
|-----------|---------|------|------------------------------------------------------------------|---------|
|           | <level> | Real | (-5 × VerticalScale - OFFSet) to<br>(5 × VerticalScale - OFFSet) | 0       |

- Remarks**
- For VerticalScale, refer to the [:CHANnel<n>:SCALE](#) command. For OFFSet, refer to the [:CHANnel<n>:OFFSet](#) command.
  - Only when the selected source is an analog channel, a digital channel, or an external trigger, can this setting command be valid.

**Return Format** The query returns the trigger level in scientific notation.

**Example** :TRIGger:EDGE:LEVel 0.16 /\*Sets the trigger level to 160 mV.\*/  
:TRIGger:EDGE:LEVel? /\*The query returns 1.600000E-1.\*/\*



## :TRIGger:PULSe

### Command List:

- ◆ [:TRIGger:PULSe:SOURce](#)
- ◆ [:TRIGger:PULSe:WHEN](#)
- ◆ [:TRIGger:PULSe:UWIDth](#)
- ◆ [:TRIGger:PULSe:LWIDth](#)
- ◆ [:TRIGger:PULSe:LEVel](#)

### :TRIGger:PULSe:SOURce

**Syntax** :TRIGger:PULSe:SOURce <source>  
:TRIGger:PULSe:SOURce?

**Description** Sets or queries the trigger source of Pulse trigger.

| Parameter | Name     | Type     | Range                                                                                       | Default  |
|-----------|----------|----------|---------------------------------------------------------------------------------------------|----------|
|           | <source> | Discrete | {D0 D1 D2 D3 D4 D5 D6 D7 D8 D9 D10 D11 D12 D13 D14 D15 CHANnel1 CHANnel2 CHANnel3 CHANnel4} | CHANnel1 |

**Return Format** The query returns D0, D1, D2, D3, D4, D5, D6, D7, D8, D9, D10, D11, D12, D13, D14, D15, CHAN1, CHAN2, CHAN3, or CHAN4.

**Example** :TRIGger:PULSe:SOURce CHANnel1 /\*Sets the trigger source to CHANnel1.\*/  
:TRIGger:PULSe:SOURce? /\*The query returns CHAN1.\*/\*

### :TRIGger:PULSe:WHEN

**Syntax** :TRIGger:PULSe:WHEN <when>  
:TRIGger:PULSe:WHEN?

**Description** Sets or queries the trigger condition of Pulse trigger.

| Parameter | Name   | Type     | Range                | Default |
|-----------|--------|----------|----------------------|---------|
|           | <when> | Discrete | {GREater LESS GLESs} | GREater |

- Remarks**
- GREater: triggers when the positive/negative pulse width of the input signal is greater than the specified pulse width.
  - LESS: triggers when the positive/negative pulse width of the input signal is smaller than the specified pulse width.
  - GLEsS: triggers when the positive/negative pulse width of the input signal is greater than the specified lower limit of pulse width and smaller than the specified upper limit of pulse width.

**Return Format** The query returns GRE, LESS, or GLEsS.

**Example** :TRIGger:PULSe:WHEN LESS /\*Sets the trigger condition to LESS.\*/  
:TRIGger:PULSe:WHEN? /\*The query returns LESS.\*/\*

**:TRIGger:PULSe:UWIDth**

**Syntax** :TRIGger:PULSe:UWIDth <width>

:TRIGger:PULSe:UWIDth?

**Description** Sets or queries the pulse upper limit of the Pulse trigger. The default unit is s.

| Parameter | Name    | Type | Range                     | Default   |
|-----------|---------|------|---------------------------|-----------|
|           | <width> | Real | Pulse lower limit to 10 s | 2 $\mu$ s |

**Remarks** The set upper limit cannot be smaller than the lower limit, otherwise, the lower limit will be automatically changed.

**Return Format** The query returns the upper limit of the pulse width in scientific notation.

**Example** :TRIGger:PULSe:UWIDth 0.000003 /\*Sets the upper limit of the pulse width to 3  $\mu$ s.\*/  
:TRIGger:PULSe:UWIDth? /\*The query returns 3.000000E-6.\*/

**:TRIGger:PULSe:LWIDth**

**Syntax** :TRIGger:PULSe:LWIDth <width>

:TRIGger:PULSe:LWIDth?

**Description** Sets or queries the pulse lower limit of the Pulse trigger. The default unit is s.

| Parameter | Name    | Type | Range                       | Default   |
|-----------|---------|------|-----------------------------|-----------|
|           | <width> | Real | 800 ps to pulse upper limit | 1 $\mu$ s |

**Remarks** The set lower limit must be smaller than the upper limit, otherwise, the upper limit will be automatically changed.

**Return Format** The query returns the lower limit of the pulse width in scientific notation.

**Example** :TRIGger:PULSe:LWIDth 0.000003 /\*Sets the lower limit of the pulse width to 3  $\mu$ s.\*/  
:TRIGger:PULSe:LWIDth? /\*The query returns 3.000000E-6.\*/

**:TRIGger:PULSe:LEVel**

**Syntax** :TRIGger:PULSe:LEVel <level>

:TRIGger:PULSe:LEVel?

**Description** Sets or queries the trigger level of Pulse trigger. The unit is the same as that of the current amplitude.

| Parameter | Name    | Type | Range                                                                       | Default |
|-----------|---------|------|-----------------------------------------------------------------------------|---------|
|           | <level> | Real | (-5 $\times$ VerticalScale - OFFSet) to (5 $\times$ VerticalScale - OFFSet) | 0       |

- Remarks**
- For VerticalScale, refer to the [:CHANnel<n>:SCALE](#) command; for OFFSet, refer to the [:CHANnel<n>:OFFSet](#) command.
  - Only when the selected source is an analog channel or an external trigger, can this setting command be valid.

**Return Format** The query returns the trigger level in scientific notation.

**Example** :TRIGger:PULSe:LEVel 0.16 /\*Sets the trigger level to 160 mV.\*/  
:TRIGger:PULSe:LEVel? /\*The query returns 1.600000E-1.\*/

## :TRIGger:SLOPe

### Command List:

- ◆ [:TRIGger:SLOPe:SOURce](#)
- ◆ [:TRIGger:SLOPe:WHEN](#)
- ◆ [:TRIGger:SLOPe:TUPPer](#)
- ◆ [:TRIGger:SLOPe:TLOWer](#)
- ◆ [:TRIGger:SLOPe:WINDow](#)
- ◆ [:TRIGger:SLOPe:ALEVel](#)
- ◆ [:TRIGger:SLOPe:BLEVel](#)

## :TRIGger:SLOPe:SOURce

**Syntax** :TRIGger:SLOPe:SOURce <channel>  
:TRIGger:SLOPe:SOURce?

**Description** Sets or queries the trigger source of Slope trigger.

| Parameter | Name      | Type     | Range                                 | Default  |
|-----------|-----------|----------|---------------------------------------|----------|
|           | <channel> | Discrete | {CHANnel1 CHANnel2 CHANnel3 CHANnel4} | CHANnel1 |

**Return Format** The query returns CHAN1, CHAN2, CHAN3, or CHAN4.

**Example** :TRIGger:SLOPe:SOURce CHANnel2 /\*Sets the trigger source to CHANnel2.\*/  
:TRIGger:SLOPe:SOURce? /\*The query returns CHAN2.\*/\*

## :TRIGger:SLOPe:WHEN

**Syntax** :TRIGger:SLOPe:WHEN <when>  
:TRIGger:SLOPe:WHEN?

**Description** Sets or queries the trigger condition of Slope trigger.

| Parameter | Name   | Type     | Range                | Default |
|-----------|--------|----------|----------------------|---------|
|           | <when> | Discrete | {GREater LESS GLESs} | GREater |

- Remarks**
- GREater: the positive slope time of the input signal is greater than the specified time value.
  - LESS: the positive slope time of the input signal is smaller than the specified time value.
  - GLEsS: the positive slope time of the input signal is greater than the specified lower time limit and smaller than the specified upper time limit.

**Return Format** The query returns GRE, LESS, or GLEsS.

**Example** :TRIGger:SLOPe:WHEN LESS /\*Sets the trigger conditions to LESS\*/  
:TRIGger:SLOPe:WHEN? /\*The query returns LESS.\*/\*

**:TRIGger:SLOPe:TUPPer**

**Syntax** :TRIGger:SLOPe:TUPPer <time>

:TRIGger:SLOPe:TUPPer?

**Description** Sets or queries the upper time limit value of the Slope trigger. The default unit is s.

| Parameter | Name   | Type | Range               | Default   |
|-----------|--------|------|---------------------|-----------|
|           | <time> | Real | Lower limit to 10 s | 1 $\mu$ s |

**Remarks** The set upper limit cannot be smaller than the lower limit, otherwise, the lower limit will be automatically changed.

**Return Format** The query returns the upper time limit in scientific notation.

**Example** :TRIGger:SLOPe:TUPPer 0.000003 /\*Sets the upper time limit to 3  $\mu$ s.\*/  
:TRIGger:SLOPe:TUPPer? /\*The query returns 3.000000E-6.\*/\*

**:TRIGger:SLOPe:TLOWer**

**Syntax** :TRIGger:SLOPe:TLOWer <time>

:TRIGger:SLOPe:TLOWer?

**Description** Sets or queries the lower time limit value of the Slope trigger. The default unit is s.

| Parameter | Name   | Type | Range               | Default   |
|-----------|--------|------|---------------------|-----------|
|           | <time> | Real | 2 ns to upper limit | 1 $\mu$ s |

**Remarks** The set lower limit must be smaller than the upper limit, otherwise, the upper limit will be automatically changed.

**Return Format** The query returns the lower time limit in scientific notation.

**Example** :TRIGger:SLOPe:TLOWer 0.000000020 /\*Sets the lower time limit to 20 ns.\*/  
:TRIGger:SLOPe:TLOWer? /\*The query returns 2.000000E-8.\*/\*

**:TRIGger:SLOPe:WINDow**

**Syntax** :TRIGger:SLOPe:WINDow <window>

:TRIGger:SLOPe:WINDow?

**Description** Sets or queries the vertical window type of Slope trigger.

| Parameter | Name     | Type     | Range       | Default |
|-----------|----------|----------|-------------|---------|
|           | <window> | Discrete | {TA TB TAB} | TA      |

- Remarks**
- TA: only adjusts the upper limit of the trigger level.
  - TB: only adjust the lower limit of the trigger level.
  - TAB: adjusts the upper and lower limits of the trigger level at the same time.

**Return Format** The query returns TA, TB, or TAB.

**Example** :TRIGger:SLOPe:WINDow TB /\*Sets the vertical window type to TB.\*/  
:TRIGger:SLOPe:WINDow? /\*The query returns TB.\*/\*

**:TRIGger:SLOPe:ALEVel**

**Syntax** :TRIGger:SLOPe:ALEVel <level>

:TRIGger:SLOPe:ALEVel?

**Description** Sets or queries the upper limit of the trigger level of Slope trigger. The unit is the same as that of the current amplitude.

| Parameter | Name    | Type | Range                                                            | Default |
|-----------|---------|------|------------------------------------------------------------------|---------|
|           | <level> | Real | Lower limit of the trigger level to (5 × VerticalScale - OFFSet) | 0 V     |

**Remarks** For VerticalScale, refer to the [:CHANnel<n>:SCALE](#) command; for OFFSet, refer to the [:CHANnel<n>:OFFSet](#) command.

**Return Format** The query returns the upper limit of the trigger level in scientific notation.

**Example** :TRIGger:SLOPe:ALEVel 0.16 /\*Sets the upper limit of the trigger level to 160 mV.\*/  
:TRIGger:SLOPe:ALEVel? /\*The query returns 1.600000E-1.\*/\*

**:TRIGger:SLOPe:BLEVel**

**Syntax** :TRIGger:SLOPe:BLEVel <level>

:TRIGger:SLOPe:BLEVel?

**Description** Sets or queries the lower limit of the trigger level of Slope trigger. The unit is the same as that of the current amplitude.

| Parameter | Name    | Type | Range                                                             | Default |
|-----------|---------|------|-------------------------------------------------------------------|---------|
|           | <level> | Real | (-5 × VerticalScale - OFFSet) to upper limit of the trigger level | 0 V     |

**Remarks** For VerticalScale, refer to the [:CHANnel<n>:SCALE](#) command; for OFFSet, refer to the [:CHANnel<n>:OFFSet](#) command.

**Return Format** The query returns the lower limit of the trigger level in scientific notation.

**Example** :TRIGger:SLOPe:BLEVel 0.16 /\*Sets the lower limit of the trigger level to 160 mV.\*/  
:TRIGger:SLOPe:BLEVel? /\*The query returns 1.600000E-1.\*/\*

## :TRIGger:VIDeo

### Command List:

- ◆ [:TRIGger:VIDeo:SOURce](#)
- ◆ [:TRIGger:VIDeo:POLarity](#)
- ◆ [:TRIGger:VIDeo:MODE](#)
- ◆ [:TRIGger:VIDeo:LINE](#)
- ◆ [:TRIGger:VIDeo:STANdard](#)
- ◆ [:TRIGger:VIDeo:LEVel](#)

## :TRIGger:VIDeo:SOURce

**Syntax** :TRIGger:VIDeo:SOURce <channel>  
:TRIGger:VIDeo:SOURce?

**Description** Sets or queries the trigger source of Video trigger.

| Parameter | Name     | Type     | Range                                 | Default  |
|-----------|----------|----------|---------------------------------------|----------|
|           | <source> | Discrete | {CHANnel1 CHANnel2 CHANnel3 CHANnel4} | CHANnel1 |

**Return Format** The query returns CHAN1, CHAN2, CHAN3, or CHAN4.

**Example** :TRIGger:VIDeo:SOURce CHANnel2 /\*Sets the trigger source to CHANnel2.\*/  
:TRIGger:VIDeo:SOURce? /\*The query returns CHAN2.\*/\*

## :TRIGger:VIDeo:POLarity

**Syntax** :TRIGger:VIDeo:POLarity <polarity>  
:TRIGger:VIDeo:POLarity?

**Description** Sets or queries the video polarity of Video trigger.

| Parameter | Name       | Type     | Range               | Default  |
|-----------|------------|----------|---------------------|----------|
|           | <polarity> | Discrete | {POSitive NEGative} | POSitive |

**Return Format** The query returns POS or NEG.

**Example** :TRIGger:VIDeo:POLarity NEGative /\*Sets the video polarity to NEGative.\*/  
:TRIGger:VIDeo:POLarity? /\*The query returns NEG.\*/\*

**:TRIGger:VIDeo:MODE**

**Syntax** :TRIGger:VIDeo:MODE <mode>

:TRIGger:VIDeo:MODE?

**Description** Sets or queries the sync type of Video trigger.

| Parameter | Name   | Type     | Range                            | Default |
|-----------|--------|----------|----------------------------------|---------|
|           | <mode> | Discrete | {ODDField EVENfield LINE ALINes} | ALINes  |

- Remarks**
- ODDField: indicates the odd field. The oscilloscope triggers on the rising edge of the first ramp waveform in the odd field. It is available when the video standard is NTSC or PAL/SECAM.
  - EVENfield: indicates the even field. The oscilloscope triggers on the rising edge of the first ramp waveform in the even field. It is available when the video standard is NTSC or PAL/SECAM.
  - LINE: for NTSC and PAL/SECAM video standards, the oscilloscope triggers on the specified line in the odd or even field. For 480P and 576P video standards, the oscilloscope triggers on the specified line.
  - ALINes: triggers on all the horizontal sync pulses.

**Return Format** The query returns ODDF, EVEN, LINE, or ALIN.

**Example** :TRIGger:VIDeo:MODE ODDField /\*Sets the sync type to ODDField.\*/  
:TRIGger:VIDeo:MODE? /\*The query returns ODDF.\*/

**:TRIGger:VIDeo:LINE**

**Syntax** :TRIGger:VIDeo:LINE <line>

:TRIGger:VIDeo:LINE?

**Description** Sets or queries the sync type of Video trigger to Line.

| Parameter | Name   | Type    | Range                   | Default |
|-----------|--------|---------|-------------------------|---------|
|           | <line> | Integer | Refer to <b>Remarks</b> | 1       |

- Remarks**
- PALSecam: 1 to 625
  - NTSC: 1 to 525
  - 480P: 1 to 525
  - 576P: 1 to 625
  - 720P60: 1 to 750
  - 720P50: 1 to 750
  - 720P30: 1 to 750
  - 720P25: 1 to 750
  - 720P24: 1 to 750
  - 1080P60: 1 to 1125
  - 1080P50: 1 to 1125
  - 1080P30: 1 to 1125
  - 1080P25: 1 to 1125
  - 1080P24: 1 to 1125
  - 1080I60: 1 to 1125
  - 1080I50: 1 to 1125

**Return Format** The query returns an integer.

**Example** :TRIGger:VIDeo:LINE 100 /\*Sets the line number to 100.\*/  
:TRIGger:VIDeo:LINE? /\*The query returns 100.\*/\*

## :TRIGger:VIDeo:STANdard

**Syntax** :TRIGger:VIDeo:STANdard <standard>  
:TRIGger:VIDeo:STANdard?

**Description** Sets or queries the video standard of Video trigger.

| Parameter | Name       | Type     | Range                                                                                                                | Default |
|-----------|------------|----------|----------------------------------------------------------------------------------------------------------------------|---------|
|           | <standard> | Discrete | {PALSecam NTSC 480P 576P 720P60 720P50 720P30 720P25 720P24 1080P60 1080P50 1080P30 1080P25 1080P24 1080I60 1080I50} | NTSC    |

### Remarks

| Video Standard | Frame Frequency (Frame) | Scan Type        | TV Scan Line |
|----------------|-------------------------|------------------|--------------|
| PALSecam       | 25                      | Interlaced Scan  | 625          |
| NTSC           | 30                      | Interlaced Scan  | 525          |
| 480P           | 60                      | Progressive Scan | 525          |
| 576P           | 50                      | Progressive Scan | 625          |
| 720P60         | 60                      | Progressive Scan | 750          |
| 720P50         | 50                      | Progressive Scan | 750          |
| 720P30         | 30                      | Progressive Scan | 750          |
| 720P25         | 25                      | Progressive Scan | 750          |
| 720P24         | 24                      | Progressive Scan | 750          |
| 1080P60        | 60                      | Progressive Scan | 1125         |
| 1080P50        | 50                      | Progressive Scan | 1125         |
| 1080P30        | 30                      | Progressive Scan | 1125         |
| 1080P25        | 25                      | Progressive Scan | 1125         |
| 1080P24        | 24                      | Progressive Scan | 1125         |
| 1080I60        | 60                      | Interlaced Scan  | 1125         |
| 1080I50        | 50                      | Interlaced Scan  | 1125         |

**Return Format** The query returns PALS, NTSC, 480P, 576P, 720P60, 720P50, 720P30, 720P25, 720P24, 1080P60, 1080P50, 1080P30, 1080P25, 1080P24, 1080I60, or 1080I50.

**Example** :TRIGger:VIDeo:STANdard NTSC /\*Selects NTSC as the video standard.\*/  
:TRIGger:VIDeo:STANdard? /\*The query returns NTSC.\*/\*

## :TRIGger:VIDeo:LEVel

**Syntax** :TRIGger:VIDeo:LEVel <level>  
:TRIGger:VIDeo:LEVel?

**Description** Sets or queries the trigger level of Video trigger. The unit is the same as that of the current amplitude.

| Parameter | Name    | Type | Range                                                         | Default |
|-----------|---------|------|---------------------------------------------------------------|---------|
|           | <level> | Real | (-5 × VerticalScale - OFFSet) to (5 × VerticalScale - OFFSet) | 0 V     |





Other channel pattern remains unchanged.\*/  
 :TRIGger:PATtern:PATtern?  
 /\*The query returns H,R,L,X,X,X,X,X,X,X,X,X,X,X,X,X,X,X,X.X.\*/

## :TRIGger:PATtern:LEVel

**Syntax** :TRIGger:PATtern:LEVel <source>,<level>

:TRIGger:PATtern:LEVel? <source>

**Description** Sets or queries the trigger level of the specified channel in Pattern trigger. The unit is the same as that of the current amplitude.

| Parameter | Name | Type     | Range                                                                                       | Default  |
|-----------|------|----------|---------------------------------------------------------------------------------------------|----------|
| <source>  |      | Discrete | {D0 D1 D2 D3 D4 D5 D6 D7 D8 D9 D10 D11 D12 D13 D14 D15 CHANnel1 CHANnel2 CHANnel3 CHANnel4} | CHANnel1 |
| <level>   |      | Real     | (-5 × VerticalScale - OFFSet) to (5 × VerticalScale - OFFSet)                               | 0        |

**Remarks** For VerticalScale, refer to the [:CHANnel<n>:SCALE](#) command. For OFFSet, refer to the [:CHANnel<n>:OFFSet](#) command.

**Return Format** The query returns the trigger level in scientific notation.

**Example** :TRIGger:PATtern:LEVel CHANnel2,0.16 /\*Sets the trigger level of CH2 to 160 mV.\*/  
 :TRIGger:PATtern:LEVel? CHANnel2 /\*The query returns 1.600000E-1.\*/

## :TRIGger:PATtern:SOURce

**Syntax** :TRIGger:PATtern:SOURce <source>

:TRIGger:PATtern:SOURce?

**Description** Sets or queries the trigger source of Pattern trigger.

| Parameter | Name | Type     | Range                                                                                       | Default  |
|-----------|------|----------|---------------------------------------------------------------------------------------------|----------|
| <source>  |      | Discrete | {D0 D1 D2 D3 D4 D5 D6 D7 D8 D9 D10 D11 D12 D13 D14 D15 CHANnel1 CHANnel2 CHANnel3 CHANnel4} | CHANnel1 |

**Return Format** The query returns D0, D1, D2, D3, D4, D5, D6, D7, D8, D9, D10, D11, D12, D13, D14, D15, CHAN1, CHAN2, CHAN3, or CHAN4.

**Example** :TRIGger:PATtern:SOURce CHANnel2 /\*Sets the trigger source to CHANnel2.\*/  
 :TRIGger:PATtern:SOURce? /\*The query returns CHAN2.\*/



channels "D0 to D15".

- In the parameter range, H indicates high level (higher than the threshold level of the channel), L indicates low level (lower than the threshold level of the channel), and X indicates omitting the channel (This channel is not used as a part of the pattern. When all the channels are set to X, the oscilloscope will not trigger.)

**Return Format** The query returns the currently set pattern of all the channels. The channels are separated by commas.

**Example** :TRIGger:DURation:TYPE L,X,H,L /\*Sets the patterns of "CH1 to CH4" to L,X,H,L. Other channel pattern remains unchanged.\*/  
 :TRIGger:DURation:TYPE? /\*The query returns L,X,H,L,X,X,X,X,X,X,X,X,X,X,X,X,X,X.X.\*/

### :TRIGger:DURation:WHEN

**Syntax** :TRIGger:DURation:WHEN <when>  
 :TRIGger:DURation:WHEN?

**Description** Sets or queries the trigger condition of Duration trigger.

| Parameter | Name   | Type     | Range                        | Default |
|-----------|--------|----------|------------------------------|---------|
|           | <when> | Discrete | {GREater LESS GLESs UNGLess} | GREater |

- Remarks**
- GREater: triggers when the set duration time of the pattern is greater than the preset time.
  - LESS: triggers when the set duration time of the pattern is smaller than the preset time.
  - GLESs: triggers when the set duration time of the pattern is smaller than the preset upper time limit and greater than the preset lower time limit.
  - UNGLess: triggers when the set duration time of the pattern is greater than the preset upper time limit and smaller than the preset lower time limit.

**Return Format** The query returns GRE, LESS, GLEs, or UNGL.

**Example** :TRIGger:DURation:WHEN LESS /\*Sets the trigger condition to LESS.\*/  
 :TRIGger:DURation:WHEN? /\*The query returns LESS.\*/

### :TRIGger:DURation:TUPPer

**Syntax** :TRIGger:DURation:TUPPer <time>  
 :TRIGger:DURation:TUPPer?

**Description** Sets or queries the upper limit of the duration time of Duration trigger. The default unit is s.

| Parameter | Name   | Type | Range          | Default |
|-----------|--------|------|----------------|---------|
|           | <time> | Real | 800 ps to 10 s | 2 μs    |

**Remarks** This command is only available when the trigger conditions are LESS and GLEs.

**Return Format** The query returns the upper limit of the duration time in scientific notation.

**Example** :TRIGger:DURation:TUPPer 0.000003 /\*Sets the upper limit of the duration time to 3 μs.\*/  
 :TRIGger:DURation:TUPPer? /\*The query returns 3.000000E-6.\*/

**:TRIGger:DURation:TLOWer**

**Syntax** :TRIGger:DURation:TLOWer <time>

:TRIGger:DURation:TLOWer?

**Description** Sets or queries the lower limit of the duration time of Duration trigger. The default unit is s.

| Parameter | Name   | Type | Range          | Default   |
|-----------|--------|------|----------------|-----------|
|           | <time> | Real | 800 ps to 10 s | 1 $\mu$ s |

**Remarks** This command is only available when the trigger conditions are GREater and GLESSs.

**Return Format** The query returns the lower limit of the duration time in scientific notation.

**Example** :TRIGger:DURation:TLOWer 0.000003 /\*Sets the lower limit of the duration time to 3  $\mu$ s.\*/

:TRIGger:DURation:TLOWer? /\*The query returns 3.000000E-6.\*/

**:TRIGger:DURation:LEVel**

**Syntax** :TRIGger:DURation:LEVel <source>,<level>

:TRIGger:DURation:LEVel? <source>

**Description** Sets or queries the trigger level of the specified channel in Duration trigger. The unit is the same as that of the current amplitude.

| Parameter | Name     | Type     | Range                                                                                       | Default  |
|-----------|----------|----------|---------------------------------------------------------------------------------------------|----------|
|           | <source> | Discrete | {D0 D1 D2 D3 D4 D5 D6 D7 D8 D9 D10 D11 D12 D13 D14 D15 CHANnel1 CHANnel2 CHANnel3 CHANnel4} | CHANnel1 |
|           | <level>  | Real     | (-5 $\times$ VerticalScale - OFFSet) to (5 $\times$ VerticalScale - OFFSet)                 | 0 V      |

**Remarks** For VerticalScale, refer to the [:CHANnel<n>:SCALE](#) command. For OFFSet, refer to the [:CHANnel<n>:OFFSet](#) command.

**Return Format** The query returns the trigger level in scientific notation.

**Example** :TRIGger:DURation:LEVel CHANnel2,0.16 /\*Sets the trigger level of CH2 to 160 mV.\*/  
:TRIGger:DURation:LEVel? CHANnel2 /\*The query returns 1.600000E-1.\*/

## :TRIGger:TIMEout

### Command List:

- ◆ [:TRIGger:TIMEout:SOURce](#)
- ◆ [:TRIGger:TIMEout:SLOPe](#)
- ◆ [:TRIGger:TIMEout:TIME](#)
- ◆ [:TRIGger:TIMEout:LEVel](#)

### :TRIGger:TIMEout:SOURce

**Syntax** :TRIGger:TIMEout:SOURce <source>  
:TRIGger:TIMEout:SOURce?

**Description** Sets or queries the trigger source of Timeout trigger.

| Parameter | Name          | Type     | Range                                                                                       | Default  |
|-----------|---------------|----------|---------------------------------------------------------------------------------------------|----------|
|           | <source><br>> | Discrete | {D0 D1 D2 D3 D4 D5 D6 D7 D8 D9 D10 D11 D12 D13 D14 D15 CHANnel1 CHANnel2 CHANnel3 CHANnel4} | CHANnel1 |

**Return Format** The query returns D0, D1, D2, D3, D4, D5, D6, D7, D8, D9, D10, D11, D12, D13, D14, D15, CHAN1, CHAN2, CHAN3, or CHAN4.

**Example** :TRIGger:TIMEout:SOURce CHANnel2 /\*Sets the trigger source to CHANnel2.\*/  
:TRIGger:TIMEout:SOURce? /\*The query returns CHAN2.\*/\*

### :TRIGger:TIMEout:SLOPe

**Syntax** :TRIGger:TIMEout:SLOPe <slope>  
:TRIGger:TIMEout:SLOPe?

**Description** Sets or queries the edge type of Timeout trigger.

| Parameter | Name    | Type     | Range                     | Default  |
|-----------|---------|----------|---------------------------|----------|
|           | <slope> | Discrete | {POSitive NEGative RFALI} | POSitive |

- Remarks**
- POSitive: starts timing when the rising edge of the input signal passes through the trigger level.
  - NEGative: starts timing when the falling edge of the input signal passes through the trigger level.
  - RFALI: starts timing when any edge of the input signal passes through the trigger level.

**Return Format** The query returns POS, NEG, or RFAL.

**Example** :TRIGger:TIMEout:SLOPe NEGative /\*Sets the edge type to NEGative.\*/  
:TRIGger:TIMEout:SLOPe? /\*The query returns NEG.\*/\*

**:TRIGger:TIMEout:TIME**

**Syntax** :TRIGger:TIMEout:TIME <time>

:TRIGger:TIMEout:TIME?

**Description** Sets or queries the timeout value of Timeout trigger. The default unit is s.

| Parameter | Name   | Type | Range         | Default   |
|-----------|--------|------|---------------|-----------|
|           | <time> | Real | 16 ns to 10 s | 1 $\mu$ s |

**Return Format** The query returns the timeout value in scientific notation.

**Example** :TRIGger:TIMEout:TIME 0.002 /\*Sets the timeout value to 2 ms.\*/  
:TRIGger:TIMEout:TIME? /\*The query returns 2.000000E-3.\*/

**:TRIGger:TIMEout:LEVEL**

**Syntax** :TRIGger:TIMEout:LEVEL <level>

:TRIGger:TIMEout:LEVEL?

**Description** Sets or queries the trigger level of Timeout trigger. The unit is the same as that of the current amplitude.

| Parameter | Name    | Type | Range                                                                       | Default |
|-----------|---------|------|-----------------------------------------------------------------------------|---------|
|           | <level> | Real | (-5 $\times$ VerticalScale - OFFSet) to (5 $\times$ VerticalScale - OFFSet) | 0 V     |

**Remarks** For VerticalScale, refer to the:CHANnel<n>:SCALE command; for OFFSet, refer to the:CHANnel<n>:OFFSet command.

**Return Format** The query returns the trigger level in scientific notation.

**Example** :TRIGger:TIMEout:LEVEL 0.16 /\*Sets the trigger level to 160 mV.\*/  
:TRIGger:TIMEout:LEVEL? /\*The query returns 1.600000E-1.\*/

## :TRIGger:RUNT

### Command List:

- ◆ [:TRIGger:RUNT:SOURce](#)
- ◆ [:TRIGger:RUNT:POLarity](#)
- ◆ [:TRIGger:RUNT:WHEN](#)
- ◆ [:TRIGger:RUNT:WUPPer](#)
- ◆ [:TRIGger:RUNT:WLOWer](#)
- ◆ [:TRIGger:RUNT:ALEVEL](#)
- ◆ [:TRIGger:RUNT:BLEVEL](#)

## :TRIGger:RUNT:SOURce

**Syntax** :TRIGger:RUNT:SOURce <source>  
:TRIGger:RUNT:SOURce?

**Description** Sets or queries the trigger source of Runt trigger.

| Parameter | Name     | Type     | Range                                 | Default  |
|-----------|----------|----------|---------------------------------------|----------|
|           | <source> | Discrete | {CHANnel1 CHANnel2 CHANnel3 CHANnel4} | CHANnel1 |

**Return Format** The query returns CHAN1, CHAN2, CHAN3, or CHAN4.

**Example** :TRIGger:RUNT:SOURce CHANnel2 /\*Sets the trigger source to CHANnel2.\*/  
:TRIGger:RUNT:SOURce? /\*The query returns CHAN2.\*/

## :TRIGger:RUNT:POLarity

**Syntax** :TRIGger:RUNT:POLarity <polarity>  
:TRIGger:RUNT:POLarity?

**Description** Sets or queries the polarity of Runt trigger.

| Parameter | Name       | Type     | Range               | Default  |
|-----------|------------|----------|---------------------|----------|
|           | <polarity> | Discrete | {POSitive NEGative} | POSitive |

- Remarks**
- POSitive: indicates the positive polarity. The oscilloscope triggers on the positive polarity of Runt trigger.
  - NEGative: indicates the negative polarity. The oscilloscope triggers on the negative polarity of Runt trigger.

**Return Format** The query returns POS or NEG.

**Example** :TRIGger:RUNT:POLarity NEGative /\*Sets the polarity of Runt trigger to NEGative.\*/  
:TRIGger:RUNT:POLarity? /\*The query returns NEG.\*/



**:TRIGger:RUNT:WHEN**

**Syntax** :TRIGger:RUNT:WHEN <when>

:TRIGger:RUNT:WHEN?

**Description** Sets or queries the qualifier of Runt trigger.

| Parameter | Name   | Type     | Range                     | Default |
|-----------|--------|----------|---------------------------|---------|
|           | <when> | Discrete | {NONE GREater LESS GLESS} | NONE    |

- Remarks**
- NONE: indicates not setting the trigger condition of Runt trigger.
  - GREater: triggers when the Runt pulse width is greater than the set lower limit of pulse width.
  - LESS: triggers when the Runt pulse width is smaller than the set upper limit of pulse width.
  - GLESS: triggers when the Runt pulse width is greater than the set lower limit and smaller than the set upper limit of pulse width.
  - The lower limit of the pulse width must be smaller than the upper limit.

**Return Format** The query returns NONE, GRE, LESS, or GLES.

**Example** :TRIGger:RUNT:WHEN LESS /\*Sets the qualifier to LESS.\*/  
:TRIGger:RUNT:WHEN? /\*The query returns LESS.\*/

**:TRIGger:RUNT:WUPPer**

**Syntax** :TRIGger:RUNT:WUPPer <width>

:TRIGger:RUNT:WUPPer?

**Description** Sets or queries the upper limit of the pulse width of Runt trigger. The default unit is s.

| Parameter | Name    | Type | Range        | Default   |
|-----------|---------|------|--------------|-----------|
|           | <width> | Real | 8 ns to 10 s | 2 $\mu$ s |

- Remarks**
- This command is only available when the qualifier is LESS or GLESS.
  - When the qualifier is set to "GLESS", the upper limit of the pulse width must be greater than the lower limit of the pulse width.

**Return Format** The query returns the upper limit of the pulse width in scientific notation.

**Example** :TRIGger:RUNT:WUPPer 0.02 /\*Sets the upper limit of the pulse width to 20 ms.\*/  
:TRIGger:RUNT:WUPPer? /\*The query returns 2.000000E-2.\*/

**:TRIGger:RUNT:WLOWer**

**Syntax** :TRIGger:RUNT:WLOWer <width>  
:TRIGger:RUNT:WLOWer?

**Description** Sets or queries the lower limit of the pulse width of Runt trigger. The default unit is s.

| Parameter | Name    | Type | Range        | Default |
|-----------|---------|------|--------------|---------|
|           | <width> | Real | 8 ns to 10 s | 8 ns    |

- Remarks**
- This command is only available when the qualifier is set to GREater or GLESSs.
  - When the qualifier is set to "GLESSs", the lower limit of the pulse width must be smaller than the upper limit of the pulse width.

**Return Format** The query returns the lower limit of the pulse width in scientific notation.

**Example** :TRIGger:RUNT:WLOWer 0.01 /\*Sets the lower limit of the pulse width to 10 ms.\*/  
:TRIGger:RUNT:WLOWer? /\*The query returns 1.000000E-2.\*/

**:TRIGger:RUNT:ALEVEL**

**Syntax** :TRIGger:RUNT:ALEVEL <level>  
:TRIGger:RUNT:ALEVEL?

**Description** Sets or queries the upper limit of the trigger level of Runt trigger. The unit is the same as that of the current amplitude.

| Parameter | Name    | Type | Range                                       | Default |
|-----------|---------|------|---------------------------------------------|---------|
|           | <level> | Real | Lower limit to (5 × VerticalScale - OFFSet) | 0 V     |

- Remarks** For VerticalScale, refer to the [:CHANnel<n>:SCALE](#) command; for OFFSet, refer to the [:CHANnel<n>:OFFSet](#) command.

**Return Format** The query returns the upper limit of the trigger level in scientific notation.

**Example** :TRIGger:RUNT:ALEVEL 0.16 /\*Sets the upper limit of the trigger level to 160 mV.\*/  
:TRIGger:RUNT:ALEVEL? /\*The query returns 1.600000E-1.\*/

**:TRIGger:RUNT:BLEVEL**

**Syntax** :TRIGger:RUNT:BLEVEL <level>  
:TRIGger:RUNT:BLEVEL?

**Description** Sets or queries the lower limit of the trigger level of Runt trigger. The unit is the same as that of the current amplitude.

| Parameter | Name    | Type | Range                                        | Default |
|-----------|---------|------|----------------------------------------------|---------|
|           | <level> | Real | (-5 × VerticalScale - OFFSet) to upper limit | 0 V     |

- Remarks** For VerticalScale, refer to the [:CHANnel<n>:SCALE](#) command; for OFFSet, refer to the [:CHANnel<n>:OFFSet](#) command.

**Return Format** The query returns the lower limit of the trigger level in scientific notation.

**Example** :TRIGger:RUNT:BLEVEL 0.16 /\*Sets the lower limit of the trigger level to 160 mV.\*/  
:TRIGger:RUNT:BLEVEL? /\*The query returns 1.600000E-1.\*/

## :TRIGger:WINDows

### Command List:

- ◆ [:TRIGger:WINDows:SOURce](#)
- ◆ [:TRIGger:WINDows:SLOPe](#)
- ◆ [:TRIGger:WINDows:POSition](#)
- ◆ [:TRIGger:WINDows:TIME](#)
- ◆ [:TRIGger:WINDows:ALEVel](#)
- ◆ [:TRIGger:WINDows:BLEVel](#)

## :TRIGger:WINDows:SOURce

**Syntax** :TRIGger:WINDows:SOURce <source>  
:TRIGger:WINDows:SOURce?

**Description** Sets or queries the trigger source of Window trigger.

| Parameter | Name     | Type     | Range                                 | Default  |
|-----------|----------|----------|---------------------------------------|----------|
|           | <source> | Discrete | {CHANnel1 CHANnel2 CHANnel3 CHANnel4} | CHANnel1 |

**Return Format** The query returns CHAN1, CHAN2, CHAN3, or CHAN4.

**Example** :TRIGger:WINDows:SOURce CHANnel2 /\*Sets the trigger source to CHANnel2.\*/  
:TRIGger:WINDows:SOURce? /\*The query returns CHAN2.\*/\*

## :TRIGger:WINDows:SLOPe

**Syntax** :TRIGger:WINDows:SLOPe <type>  
:TRIGger:WINDows:SLOPe?

**Description** Sets or queries the window type of Window trigger.

| Parameter | Name   | Type     | Range                     | Default  |
|-----------|--------|----------|---------------------------|----------|
|           | <type> | Discrete | {POSitive NEGative RFALI} | POSitive |

- Remarks**
- POSitive: triggers on the rising edge of the input signal when the voltage level is greater than the preset high trigger level.
  - NEGative: triggers on the falling edge of the input signal when the voltage level is smaller than the preset low trigger level.
  - RFALI: triggers on either the rising or falling edge of the input signal when the voltage level meets the preset trigger level.

**Return Format** The query returns POS, NEG, or RFAL.

**Example** :TRIGger:WINDows:SLOPe NEGative /\*Sets the window type to NeGative.\*/  
:TRIGger:WINDows:SLOPe? /\*The query returns NEG.\*/\*

**:TRIGger:WINDows:POSition****Syntax** :TRIGger:WINDows:POSition <pos>

:TRIGger:WINDows:POSition?

**Description** Sets or queries the trigger position of Window trigger.

| Parameter | Name   | Type     | Range             | Default |
|-----------|--------|----------|-------------------|---------|
|           | <type> | Discrete | {EXIT ENTer TIME} | ENTer   |

- Remarks**
- EXIT: triggers when the input signal exits the specified trigger level range.
  - ENTer: triggers when the input signal enters the specified trigger level range.
  - TIME: triggers when the accumulated hold time after the trigger signal enters the specified trigger level range is equal to the window time.

**Return Format** The query returns EXIT, ENT, or TIME.

**Example** :TRIGger:WINDows:POSition ENT /\*Sets the trigger position to ENT.\*/  
 :TRIGger:WINDows:POSition? /\*The query returns ENT.\*/

**:TRIGger:WINDows:TIME****Syntax** :TRIGger:WINDows:TIME <time>

:TRIGger:WINDows:TIME?

**Description** Sets or queries the window time of Window trigger.

| Parameter | Name   | Type | Range        | Default   |
|-----------|--------|------|--------------|-----------|
|           | <time> | Real | 8 ns to 10 s | 1 $\mu$ s |

**Return Format** The query returns the window time in scientific notation.

**Example** :TRIGger:WINDows:TIME 0.002 /\*Sets the window time to 2 ms.\*/  
 :TRIGger:WINDows:TIME? /\*The query returns 2.000000E-3.\*/

**:TRIGger:WINDows:ALEVel****Syntax** :TRIGger:WINDows:ALEVel <level>

:TRIGger:WINDows:ALEVel?

**Description** Sets or queries the upper limit of the trigger level of Window trigger. The unit is the same as that of the current amplitude.

| Parameter | Name    | Type | Range                                       | Default |
|-----------|---------|------|---------------------------------------------|---------|
|           | <level> | Real | Lower limit to (5 × VerticalScale - OFFSet) | 0 V     |

**Remarks** For VerticalScale, refer to the [:CHANnel<n>:SCALE](#) command; for OFFSet, refer to the [:CHANnel<n>:OFFSet](#) command.**Return Format** The query returns the upper limit of the trigger level in scientific notation.

**Example** :TRIGger:WINDows:ALEVel 0.16 /\*Sets the upper limit of the trigger level to 160 mV.\*/  
 :TRIGger:WINDows:ALEVel? /\*The query returns 1.600000E-1.\*/

**:TRIGger:WINDows:BLEVel**

**Syntax** :TRIGger:WINDows:BLEVel <level>

:TRIGger:WINDows:BLEVel?

**Description** Sets or queries the lower limit of the trigger level of Window trigger. The unit is the same as that of the current amplitude.

| Parameter | Name    | Type | Range                                        | Default |
|-----------|---------|------|----------------------------------------------|---------|
|           | <level> | Real | (-5 × VerticalScale - OFFSet) to upper limit | 0 V     |

**Remarks** For VerticalScale, refer to the [:CHANnel<n>:SCALE](#) command; for OFFSet, refer to the [:CHANnel<n>:OFFSet](#) command.

**Return Format** The query returns the lower limit of the trigger level in scientific notation.

**Example** :TRIGger:WINDows:BLEVel 0.05 /\*Sets the lower limit of the trigger level to 50 mV.\*/  
:TRIGger:WINDows:BLEVel? /\*The query returns 5.000000E-2.\*/

## :TRIGger:DElay

### Command List:

- ◆ [:TRIGger:DElay:SA](#)
- ◆ [:TRIGger:DElay:SLOPa](#)
- ◆ [:TRIGger:DElay:SB](#)
- ◆ [:TRIGger:DElay:SLOPb](#)
- ◆ [:TRIGger:DElay:TYPE](#)
- ◆ [:TRIGger:DElay:TUPPer](#)
- ◆ [:TRIGger:DElay:TLOWer](#)
- ◆ [:TRIGger:DElay:ALEVel](#)
- ◆ [:TRIGger:DElay:BLEVel](#)

## :TRIGger:DElay:SA

**Syntax** :TRIGger:DElay:SA <Source>  
:TRIGger:DElay:SA?

**Description** Sets or queries the trigger source of Source A in Delay trigger.

| Parameter | Name     | Type     | Range                                                                                       | Default  |
|-----------|----------|----------|---------------------------------------------------------------------------------------------|----------|
|           | <source> | Discrete | {D0 D1 D2 D3 D4 D5 D6 D7 D8 D9 D10 D11 D12 D13 D14 D15 CHANnel1 CHANnel2 CHANnel3 CHANnel4} | CHANnel1 |

**Return Format** The query returns D0, D1, D2, D3, D4, D5, D6, D7, D8, D9, D10, D11, D12, D13, D14, D15, CHAN1, CHAN2, CHAN3, or CHAN4.

**Example** :TRIGger:DElay:SA CHANnel2 /\*Sets trigger source A to CHANnel2.\*/  
:TRIGger:DElay:SA? /\*The query returns CHAN2.\*/\*

## :TRIGger:DElay:SLOPa

**Syntax** :TRIGger:DElay:SLOPa <slope>  
:TRIGger:DElay:SLOPa?

**Description** Sets or queries the edge type of Edge A in Delay trigger.

| Parameter | Name    | Type     | Range               | Default  |
|-----------|---------|----------|---------------------|----------|
|           | <slope> | Discrete | {POSitive NEGative} | POSitive |

**Return Format** The query returns POS or NEG.

**Example** :TRIGger:DElay:SLOPa NEGative /\*Sets the type of Edge A to NEGative.\*/  
:TRIGger:DElay:SLOPa? /\*The query returns NEG.\*/\*

**:TRIGger:DElay:SB**

**Syntax** :TRIGger:DElay:SB <source>

:TRIGger:DElay:SB?

**Description** Sets or queries the trigger source of Source B in Delay trigger.

| Parameter | Name     | Type     | Range                                                                                       | Default  |
|-----------|----------|----------|---------------------------------------------------------------------------------------------|----------|
|           | <source> | Discrete | {D0 D1 D2 D3 D4 D5 D6 D7 D8 D9 D10 D11 D12 D13 D14 D15 CHANnel1 CHANnel2 CHANnel3 CHANnel4} | CHANnel2 |

**Return Format** The query returns D0, D1, D2, D3, D4, D5, D6, D7, D8, D9, D10, D11, D12, D13, D14, D15, CHAN1, CHAN2, CHAN3, or CHAN4.

**Example** :TRIGger:DElay:SB CHANnel4 /\*Sets trigger source B to CHANnel4.\*/  
:TRIGger:DElay:SB? /\*The query returns CHAN4.\*/\*

**:TRIGger:DElay:SLOpb**

**Syntax** :TRIGger:DElay:SLOpb <slope>

:TRIGger:DElay:SLOpb?

**Description** Sets or queries the edge type of Edge B in Delay trigger.

| Parameter | Name    | Type     | Range               | Default  |
|-----------|---------|----------|---------------------|----------|
|           | <slope> | Discrete | {POSitive NEGative} | POSitive |

**Return Format** The query returns POS or NEG.

**Example** :TRIGger:DElay:SLOpb NEGative /\*Sets the type of Edge B to NEGative.\*/  
:TRIGger:DElay:SLOpb? /\*The query returns NEG.\*/\*

**:TRIGger:DElay:TYPE**

**Syntax** :TRIGger:DElay:TYPE <type>

:TRIGger:DElay:TYPE?

**Description** Sets or queries the delay type of Delay trigger.

| Parameter | Name   | Type     | Range                      | Default |
|-----------|--------|----------|----------------------------|---------|
|           | <type> | Discrete | {GREater LESS GLESSs GOUT} | GREater |

- Remarks**
- GREater: triggers when the time difference ( $\Delta T$ ) between the specified edges of Source A and Source B is greater than the preset time limit.
  - LESS: triggers when the time difference ( $\Delta T$ ) between the specified edges of Source A and Source B is smaller than the preset time limit.
  - GLESSs: triggers when the time difference ( $\Delta T$ ) between the specified edges of Source A and Source B is greater than the lower limit of the preset time and smaller than the upper limit of the preset time. Note: The lower time limit must be smaller than the upper time limit.
  - GOUT: triggers when the time difference ( $\Delta T$ ) between the specified edges of Source A and Source B is smaller than the lower limit of the preset time or greater than the upper limit of the preset time. Note: The lower time limit must be smaller than the upper time limit.

**Return Format** The query returns GRE, LESS, GLES, or GOUT.

**Example** :TRIGger:DElay:TYPE GOUT /\*Sets the delay type to GOUT.\*/  
:TRIGger:DElay:TYPE? /\*The query returns GOUT.\*/\*

### :TRIGger:DElay:TUPPer

**Syntax** :TRIGger:DElay:TUPPer <time>  
:TRIGger:DElay:TUPPer?

**Description** Sets or queries the upper limit of delay time of the Delay trigger. The default unit is s.

| Parameter | Name   | Type | Range        | Default   |
|-----------|--------|------|--------------|-----------|
|           | <time> | Real | 8 ns to 10 s | 2 $\mu$ s |

**Remarks** This command is available when the delay type is LESS, GOUT, or GLEsS.

**Return Format** The query returns the upper limit of delay time in scientific notation.

**Example** :TRIGger:DElay:TUPPer 0.002 /\*Sets the upper limit of delay time to 2 ms.\*/  
:TRIGger:DElay:TUPPer? /\*The query returns 2.000000E-3.\*/\*

### :TRIGger:DElay:TLOWer

**Syntax** :TRIGger:DElay:TLOWer <time>  
:TRIGger:DElay:TLOWer?

**Description** Sets or queries the lower limit of delay time of the Delay trigger. The default unit is s.

| Parameter | Name   | Type | Range        | Default   |
|-----------|--------|------|--------------|-----------|
|           | <time> | Real | 8 ns to 10 s | 1 $\mu$ s |

**Remarks** This command is available when the delay type is GREater, GOUT, or GLEsS.

**Return Format** The query returns the lower limit of delay time in scientific notation.

**Example** :TRIGger:DElay:TLOWer 0.002 /\*Sets the lower limit of delay time to 2 ms.\*/  
:TRIGger:DElay:TLOWer? /\*The query returns 2.000000E-3.\*/\*

### :TRIGger:DElay:ALEVel

**Syntax** :TRIGger:DElay:ALEVel <level>  
:TRIGger:DElay:ALEVel?

**Description** Sets or queries the threshold level of source A of Delay trigger. The unit is the same as that of the current amplitude.

| Parameter | Name    | Type | Range                                                     | Default |
|-----------|---------|------|-----------------------------------------------------------|---------|
|           | <level> | Real | (-5×VerticalScale-OFFSet) to (5 × VerticalScale - OFFSet) | 0 V     |

**Remarks** For VerticalScale, refer to the [:CHANnel<n>:SCALE](#) command; for OFFSet, refer to the [:CHANnel<n>:OFFSet](#) command.

**Return Format** The query returns the threshold level of source A in scientific notation.



**Example** :TRIGger:DElay:ALEVel 0.16 /\*Sets the threshold level of source A to 160 mV.\*/  
 :TRIGger:DElay:ALEVel? /\*The query returns 1.600000E-1.\*/

### :TRIGger:DElay:BLEVel

**Syntax** :TRIGger:DElay:BLEVel <level>  
 :TRIGger:DElay:BLEVel?

**Description** Sets or queries the threshold level of source B of Delay trigger. The unit is the same as that of the current amplitude.

**Parameter**

| Name    | Type | Range                                                     | Default |
|---------|------|-----------------------------------------------------------|---------|
| <level> | Real | (-5 × VerticalScale - OFFSet) to (5×VerticalScale-OFFSet) | 0 V     |

**Remarks** For VerticalScale, refer to the [:CHANnel<n>:SCALE](#) command; for OFFSet, refer to the [:CHANnel<n>:OFFSet](#) command.

**Return Format** The query returns the threshold level of source B in scientific notation.

**Example** :TRIGger:DElay:BLEVel 0.05 /\*Sets the threshold level of source B to 50 mV.\*/  
 :TRIGger:DElay:BLEVel? /\*The query returns 5.000000E-2.\*/

## :TRIGger:SHOLd

### Command List:

- ◆ [:TRIGger:SHOLd:DSRC](#)
- ◆ [:TRIGger:SHOLd:CSRC](#)
- ◆ [:TRIGger:SHOLd:SLOPe](#)
- ◆ [:TRIGger:SHOLd:PATtern](#)
- ◆ [:TRIGger:SHOLd:TYPE](#)
- ◆ [:TRIGger:SHOLd:STIME](#)
- ◆ [:TRIGger:SHOLd:HTIME](#)
- ◆ [:TRIGger:SHOLd:DLEVel](#)
- ◆ [:TRIGger:SHOLd:CLEVel](#)

## :TRIGger:SHOLd:DSRC

**Syntax** :TRIGger:SHOLd:DSRC <source>  
:TRIGger:SHOLd:DSRC?

**Description** Sets or queries the data source of Setup&Hold trigger.

| Parameter | Name     | Type     | Range                                                                                       | Default  |
|-----------|----------|----------|---------------------------------------------------------------------------------------------|----------|
|           | <source> | Discrete | {D0 D1 D2 D3 D4 D5 D6 D7 D8 D9 D10 D11 D12 D13 D14 D15 CHANnel1 CHANnel2 CHANnel3 CHANnel4} | CHANnel2 |

**Return Format** The query returns D0, D1, D2, D3, D4, D5, D6, D7, D8, D9, D10, D11, D12, D13, D14, D15, CHAN1, CHAN2, CHAN3, or CHAN4.

**Example** :TRIGger:SHOLd:DSRC CHANnel1 /\*Sets the data source to CHANnel1.\*/  
:TRIGger:SHOLd:DSRC? /\*The query returns CHAN1.\*/\*

## :TRIGger:SHOLd:CSRC

**Syntax** :TRIGger:SHOLd:CSRC <source>  
:TRIGger:SHOLd:CSRC?

**Description** Sets or queries the clock source of Setup&Hold trigger.

| Parameter | Name     | Type     | Range                                                                                       | Default  |
|-----------|----------|----------|---------------------------------------------------------------------------------------------|----------|
|           | <source> | Discrete | {D0 D1 D2 D3 D4 D5 D6 D7 D8 D9 D10 D11 D12 D13 D14 D15 CHANnel1 CHANnel2 CHANnel3 CHANnel4} | CHANnel1 |

**Return Format** The query returns D0, D1, D2, D3, D4, D5, D6, D7, D8, D9, D10, D11, D12, D13, D14, D15, CHAN1, CHAN2, CHAN3, or CHAN4.

**Example** :TRIGger:SHOLd:CSRC CHANnel2 /\*Sets the clock source to CHANnel2.\*/  
:TRIGger:SHOLd:CSRC? /\*The query returns CHAN2.\*/\*

**:TRIGger:SHOLd:SLOPe**

**Syntax** :TRIGger:SHOLd:SLOPe <slope>

:TRIGger:SHOLd:SLOPe?

**Description** Sets or queries the edge type of Setup&Hold trigger.

| Parameter | Name    | Type     | Range               | Default  |
|-----------|---------|----------|---------------------|----------|
|           | <slope> | Discrete | {POSitive NEGative} | POSitive |

**Return Format** The query returns POS or NEG.

**Example** :TRIGger:SHOLd:SLOPe NEGative /\*Sets the edge type to NEGative.\*/  
:TRIGger:SHOLd:SLOPe? /\*The query returns NEG.\*/

**:TRIGger:SHOLd:PATtern**

**Syntax** :TRIGger:SHOLd:PATtern <pattern>

:TRIGger:SHOLd:PATtern?

**Description** Sets or queries the data type of Setup&Hold trigger.

| Parameter | Name      | Type     | Range | Default |
|-----------|-----------|----------|-------|---------|
|           | <pattern> | Discrete | {H L} | H       |

**Remarks** H: indicates high level.  
L: indicates low level.

**Return Format** The query returns H or L.

**Example** :TRIGger:SHOLd:PATtern L /\*Sets data type to L.\*/  
:TRIGger:SHOLd:PATtern? /\*The query returns L.\*/

**:TRIGger:SHOLd:TYPE**

**Syntax** :TRIGger:SHOLd:TYPE <type>

:TRIGger:SHOLd:TYPE?

**Description** Sets or queries the hold type of Setup&Hold trigger.

| Parameter | Name   | Type     | Range                | Default |
|-----------|--------|----------|----------------------|---------|
|           | <type> | Discrete | {SETup HOLD SETHold} | SETup   |

- Remarks**
- SETup: the oscilloscope triggers when the setup time is smaller than the specified setup time.
  - HOLD: the oscilloscope triggers when the hold time is smaller than the specified hold time.
  - SETHold: the oscilloscope triggers when the setup time or hold time is smaller than the specified time value.

**Return Format** The query returns SET, HOLD, or SETH.

**Example** :TRIGger:SHOLd:TYPE SETHold /\*Sets the hold type to SETHold.\*/  
:TRIGger:SHOLd:TYPE? /\*The query returns SETH.\*/

**:TRIGger:SHOLd:STIMe**

**Syntax** :TRIGger:SHOLd:STIMe <time>

:TRIGger:SHOLd:STIMe?

**Description** Sets or queries the setup time of Setup&Hold trigger. The default unit is s.

| Parameter | Name   | Type | Range       | Default   |
|-----------|--------|------|-------------|-----------|
|           | <time> | Real | 8 ns to 1 s | 1 $\mu$ s |

- Remarks**
- Setup time indicates the time that the data remain stable and unchanged before the clock signal of the trigger comes.
  - This command is only available when the hold type is SETup or SETHOLD.

**Return Format** The query returns the setup time value in scientific notation.

**Example** :TRIGger:SHOLd:STIMe 0.002 /\*Sets the setup time to 2 ms.\*/  
:TRIGger:SHOLd:STIMe? /\*The query returns 2.000000E-3.\*/

**:TRIGger:SHOLd:HTIMe**

**Syntax** :TRIGger:SHOLd:HTIMe <time>

:TRIGger:SHOLd:HTIMe?

**Description** Sets or queries the hold time of Setup&Hold trigger. The default unit is s.

| Parameter | Name   | Type | Range       | Default   |
|-----------|--------|------|-------------|-----------|
|           | <time> | Real | 8 ns to 1 s | 1 $\mu$ s |

- Remarks**
- Hold time indicates the time that the data remain stable and unchanged after the clock signal of the trigger comes.
  - This command is only available when the hold type is HOLD or SETHold.

**Return Format** The query returns the hold time value in scientific notation.

**Example** :TRIGger:SHOLd:HTIMe 0.002 /\*Sets the hold time to 2 ms.\*/  
:TRIGger:SHOLd:HTIMe? /\*The query returns 2.000000E-3.\*/

**:TRIGger:SHOLd:DLEVel**

**Syntax** :TRIGger:SHOLd:DLEVel <level>

:TRIGger:SHOLd:DLEVel?

**Description** Sets or queries the trigger level of the data source. The unit is the same as that of the current amplitude.

| Parameter | Name    | Type | Range                                                         | Default |
|-----------|---------|------|---------------------------------------------------------------|---------|
|           | <level> | Real | (-5 × VerticalScale - OFFSet) to (5 × VerticalScale - OFFSet) | 0 V     |

- Remarks** For VerticalScale, refer to the [:CHANnel<n>:SCALE](#) command; for OFFSet, refer to the [:CHANnel<n>:OFFSet](#) command.

**Return Format** The query returns the trigger level of the data source in scientific notation.

**Example** :TRIGger:SHOLd:DLEVel 0.16 /\*Sets the trigger level of the data source to 160 mV.\*/  
:TRIGger:SHOLd:DLEVel? /\*The query returns 1.600000E-1.\*/

**:TRIGger:SHOLd:CLEVel**

**Syntax** :TRIGger:SHOLd:CLEVel <level>

:TRIGger:SHOLd:CLEVel?

**Description** Sets or queries the trigger level of the clock source. The unit is the same as that of the current amplitude.

| Parameter | Name    | Type | Range                                                            | Default |
|-----------|---------|------|------------------------------------------------------------------|---------|
|           | <level> | Real | (-5 × VerticalScale - OFFSet) to<br>(5 × VerticalScale - OFFSet) | 0 V     |

**Remarks** For VerticalScale, refer to the [:CHANnel<n>:SCALE](#) command; for OFFSet, refer to the [:CHANnel<n>:OFFSet](#) command.

**Return Format** The query returns the trigger level of the clock source in scientific notation.

**Example** :TRIGger:SHOLd:CLEVel 0.05 /\*Sets the trigger level of the clock source to 50 mV.\*/  
:TRIGger:SHOLd:CLEVel? /\*The query returns 5.000000E-2.\*/

## :TRIGger:NEDGE

### Command List:

- ◆ [:TRIGger:NEDGE:SOURce](#)
- ◆ [:TRIGger:NEDGE:SLOPe](#)
- ◆ [:TRIGger:NEDGE:IDLE](#)
- ◆ [:TRIGger:NEDGE:EDGE](#)
- ◆ [:TRIGger:NEDGE:LEVel](#)

## :TRIGger:NEDGE:SOURce

**Syntax** :TRIGger:NEDGE:SOURce <source>  
:TRIGger:NEDGE:SOURce?

**Description** Sets or queries the trigger source of the Nth Edge trigger.

| Parameter | Name     | Type     | Range                                                                                       | Default  |
|-----------|----------|----------|---------------------------------------------------------------------------------------------|----------|
|           | <source> | Discrete | {D0 D1 D2 D3 D4 D5 D6 D7 D8 D9 D10 D11 D12 D13 D14 D15 CHANnel1 CHANnel2 CHANnel3 CHANnel4} | CHANnel1 |

**Return Format** The query returns D0, D1, D2, D3, D4, D5, D6, D7, D8, D9, D10, D11, D12, D13, D14, D15, CHAN1, CHAN2, CHAN3, or CHAN4.

**Example** :TRIGger:NEDGE:SOURce CHANnel2 /\*Sets the trigger source to CHANnel2.\*/  
:TRIGger:NEDGE:SOURce? /\*The query returns CHAN2.\*/\*

## :TRIGger:NEDGE:SLOPe

**Syntax** :TRIGger:NEDGE:SLOPe <slope>  
:TRIGger:NEDGE:SLOPe?

**Description** Sets or queries the edge type of the Nth Edge trigger.

| Parameter | Name    | Type     | Range               | Default  |
|-----------|---------|----------|---------------------|----------|
|           | <slope> | Discrete | {POSitive NEGative} | POSitive |

- Remarks**
- POSitive: indicates that the oscilloscope triggers on the rising edge of the input signal when the voltage level meets the preset trigger level.
  - NEGative: indicates that the oscilloscope triggers on the falling edge of the input signal when the voltage level meets the preset trigger level.

**Return Format** The query returns POS or NEG.

**Example** :TRIGger:NEDGE:SLOPe NEGative /\*Sets the edge type to NEGative.\*/  
:TRIGger:NEDGE:SLOPe? /\*The query returns NEG.\*/\*

**:TRIGger:NEDGE:IDLE**

**Syntax** :TRIGger:NEDGE:IDLE <time>

:TRIGger:NEDGE:IDLE?

**Description** Sets or queries the idle time of the Nth Edge trigger. The default unit is s.

| Parameter | Name   | Type | Range         | Default   |
|-----------|--------|------|---------------|-----------|
|           | <time> | Real | 16 ns to 10 s | 1 $\mu$ s |

**Return Format** The query returns the idle time in scientific notation.

**Example** :TRIGger:NEDGE:IDLE 0.002 /\*Sets the idle time to 2 ms.\*/  
:TRIGger:NEDGE:IDLE? /\*The query returns 2.000000E-3.\*/

**:TRIGger:NEDGE:EDGE**

**Syntax** :TRIGger:NEDGE:EDGE <edge>

:TRIGger:NEDGE:EDGE?

**Description** Sets or queries the number of edges of the Nth Edge trigger.

| Parameter | Name   | Type    | Range      | Default |
|-----------|--------|---------|------------|---------|
|           | <edge> | Integer | 1 to 65535 | 2       |

**Return Format** The query returns an integer ranging from 1 to 65535.

**Example** :TRIGger:NEDGE:EDGE 20 /\*Sets the number of edges to 20.\*/  
:TRIGger:NEDGE:EDGE? /\*The query returns 20.\*/

**:TRIGger:NEDGE:LEVEL**

**Syntax** :TRIGger:NEDGE:LEVEL <level>

:TRIGger:NEDGE:LEVEL?

**Description** Sets or queries the trigger level of the Nth Edge trigger. The unit is the same as that of current amplitude.

| Parameter | Name    | Type | Range                                                                       | Default |
|-----------|---------|------|-----------------------------------------------------------------------------|---------|
|           | <level> | Real | (-5 $\times$ VerticalScale - OFFSet) to (5 $\times$ VerticalScale - OFFSet) | 0 V     |

**Remarks** For VerticalScale, refer to the [:CHANnel<n>:SCALE](#) command; for OFFSet, refer to the [:CHANnel<n>:OFFSet](#) command.

**Return Format** The query returns the trigger level in scientific notation.

**Example** :TRIGger:NEDGE:LEVEL 0.16 /\*Sets the trigger level to 160 mV.\*/  
:TRIGger:NEDGE:LEVEL? /\*The query returns 1.600000E-1.\*/

## :TRIGger:RS232 (Option)

### Command List:

- ◆ [:TRIGger:RS232:SOURce](#)
- ◆ [:TRIGger:RS232:WHEN](#)
- ◆ [:TRIGger:RS232:PARity](#)
- ◆ [:TRIGger:RS232:STOP](#)
- ◆ [:TRIGger:RS232:DATA](#)
- ◆ [:TRIGger:RS232:WIDTh](#)
- ◆ [:TRIGger:RS232:BAUD](#)
- ◆ [:TRIGger:RS232:LEVel](#)

### :TRIGger:RS232:SOURce

**Syntax** :TRIGger:RS232:SOURce <source>

:TRIGger:RS232:SOURce?

**Description** Sets or queries the trigger source of RS232 trigger.

| Parameter | Name     | Type     | Range                                                                                       | Default  |
|-----------|----------|----------|---------------------------------------------------------------------------------------------|----------|
|           | <source> | Discrete | {D0 D1 D2 D3 D4 D5 D6 D7 D8 D9 D10 D11 D12 D13 D14 D15 CHANnel1 CHANnel2 CHANnel3 CHANnel4} | CHANnel1 |

**Return Format** The query returns D0, D1, D2, D3, D4, D5, D6, D7, D8, D9, D10, D11, D12, D13, D14, D15, CHAN1, CHAN2, CHAN3, or CHAN4.

**Example** :TRIGger:RS232:SOURce CHANnel2 /\*Sets the trigger source to CHANnel2.\*/  
:TRIGger:RS232:SOURce? /\*The query returns CHAN2.\*/

### :TRIGger:RS232:WHEN

**Syntax** :TRIGger:RS232:WHEN <when>

:TRIGger:RS232:WHEN?

**Description** Sets or queries the trigger condition of RS232 trigger.

| Parameter | Name   | Type     | Range                     | Default |
|-----------|--------|----------|---------------------------|---------|
|           | <when> | Discrete | {START ERRor CERRor DATA} | START   |

- Remarks**
- START: triggers at the start of a frame.
  - ERRor: triggers when an error frame is found.
  - CERRor: triggers when the check error is found.
  - DATA: triggers on the last bit of the preset data bits and even-odd check bit.

**Return Format** The query returns STAR, ERR, CERR, or DATA.

**Example** :TRIGger:RS232:WHEN ERRor /\*Sets the trigger condition to ERRor.\*/  
:TRIGger:RS232:WHEN? /\*The query returns ERR.\*/



**:TRIGger:RS232:PARity**

**Syntax** :TRIGger:RS232:PARity <parity>

:TRIGger:RS232:PARity?

**Description** Sets or queries the check mode of RS232 trigger.

| Parameter | Name     | Type     | Range           | Default |
|-----------|----------|----------|-----------------|---------|
|           | <parity> | Discrete | {EVEN ODD NONE} | NONE    |

**Return Format** The query returns EVEN, ODD, or NONE.

**Example** :TRIGger:RS232:PARity EVEN /\*Sets the check mode to EVEN.\*/  
:TRIGger:RS232:PARity? /\*The query returns EVEN.\*/

**:TRIGger:RS232:STOP**

**Syntax** :TRIGger:RS232:STOP <bit>

:TRIGger:RS232:STOP?

**Description** Sets or queries the stop bits of RS232 trigger.

| Parameter | Name  | Type     | Range     | Default |
|-----------|-------|----------|-----------|---------|
|           | <bit> | Discrete | {1 1.5 2} | 1       |

**Return Format** The query returns 1, 1.5 or 2.

**Example** :TRIGger:RS232:STOP 2 /\*Sets the stop bits to 2.\*/  
:TRIGger:RS232:STOP? /\*The query returns 2.\*/

**:TRIGger:RS232:DATA**

**Syntax** :TRIGger:RS232:DATA <data>

:TRIGger:RS232:DATA?

**Description** Sets or queries the data value of RS232 trigger when the trigger condition is "Data".

| Parameter | Name   | Type    | Range          | Default |
|-----------|--------|---------|----------------|---------|
|           | <data> | Integer | 0 to $2^n - 1$ | 0       |

**Remarks** In the expression  $2^n - 1$ , n indicates the current data width, and its available value can be 5, 6, 7, or 8.

**Return Format** The query returns an integer.

**Example** :TRIGger:RS232:DATA 10 /\*Sets the data value to 10.\*/  
:TRIGger:RS232:DATA? /\*The query returns 10.\*/

**:TRIGger:RS232:WIDTh**

**Syntax** :TRIGger:RS232:WIDTh <width>

:TRIGger:RS232:WIDTh?

**Description** Sets or queries the data width of RS232 trigger when the trigger condition is "Data".

| Parameter | Name    | Type     | Range     | Default |
|-----------|---------|----------|-----------|---------|
|           | <width> | Discrete | {5 6 7 8} | 8       |

**Return Format** The query returns 5, 6, 7, or 8.

**Example** :TRIGger:RS232:WIDTh 6 /\*Sets the data width to 6.\*/

:TRIGger:RS232:WIDTh? /\*The query returns 6.\*/

**:TRIGger:RS232:BAUD**

**Syntax** :TRIGger:RS232:BAUD <baud>

:TRIGger:RS232:BAUD?

**Description** Sets or queries the baud rate of RS232 trigger. The default unit is bps.

| Parameter | Name   | Type    | Range            | Default  |
|-----------|--------|---------|------------------|----------|
|           | <baud> | Integer | 1 bps to 20 Mbps | 9600 bps |

**Remarks** If the baud rate is set to a value with "M", then "A" should be added at the end of the value. For example, if you send 5 M, you need to send 5 MA.

**Return Format** The query returns an integer ranging from 1 bps to 20 Mbps.

**Example** :TRIGger:RS232:BAUD 4800 /\*Sets the baud rate to 4800bps.\*/

:TRIGger:RS232:BAUD? /\*The query returns 4800.\*/

**:TRIGger:RS232:LEVel**

**Syntax** :TRIGger:RS232:LEVel <level>

:TRIGger:RS232:LEVel?

**Description** Sets or queries the trigger level of RS232 trigger. The unit is the same as that of the current amplitude.

| Parameter | Name    | Type | Range                                                         | Default |
|-----------|---------|------|---------------------------------------------------------------|---------|
|           | <level> | Real | (-5 × VerticalScale - OFFSet) to (5 × VerticalScale - OFFSet) | 0 V     |

**Remarks** For VerticalScale, refer to the [:CHANnel<n>:SCALE](#) command; for OFFSet, refer to the [:CHANnel<n>:OFFSet](#) command.

**Return Format** The query returns the trigger level in scientific notation.

**Example** :TRIGger:RS232:LEVel 0.16 /\*Sets the trigger level to 160 mV.\*/

:TRIGger:RS232:LEVel? /\*The query returns 1.600000E-1.\*/

## :TRIGger:IIC (Option)

### Command List:

- ◆ [:TRIGger:IIC:SCL](#)
- ◆ [:TRIGger:IIC:SDA](#)
- ◆ [:TRIGger:IIC:WHEN](#)
- ◆ [:TRIGger:IIC:AWIDth](#)
- ◆ [:TRIGger:IIC:ADDRes](#)
- ◆ [:TRIGger:IIC:DIRection](#)
- ◆ [:TRIGger:IIC:DATA](#)
- ◆ [:TRIGger:IIC:CLEVel](#)
- ◆ [:TRIGger:IIC:DLEVel](#)

### :TRIGger:IIC:SCL

**Syntax** :TRIGger:IIC:SCL <source>  
:TRIGger:IIC:SCL?

**Description** Sets or queries the source channel of the clock line of I2C trigger.

| Parameter | Name     | Type     | Range                                                                                       | Default  |
|-----------|----------|----------|---------------------------------------------------------------------------------------------|----------|
|           | <source> | Discrete | {D0 D1 D2 D3 D4 D5 D6 D7 D8 D9 D10 D11 D12 D13 D14 D15 CHANnel1 CHANnel2 CHANnel3 CHANnel4} | CHANnel1 |

**Return Format** The query returns D0, D1, D2, D3, D4, D5, D6, D7, D8, D9, D10, D11, D12, D13, D14, D15, CHAN1, CHAN2, CHAN3, or CHAN4.

**Example** :TRIGger:IIC:SCL CHANnel2 /\*Sets the clock source to CHANnel2.\*/  
:TRIGger:IIC:SCL? /\*The query returns CHAN2.\*/\*

### :TRIGger:IIC:SDA

**Syntax** :TRIGger:IIC:SDA <source>  
:TRIGger:IIC:SDA?

**Description** Sets or queries the source channel of the data line of I2C trigger.

| Parameter | Name     | Type     | Range                                                                                       | Default  |
|-----------|----------|----------|---------------------------------------------------------------------------------------------|----------|
|           | <source> | Discrete | {D0 D1 D2 D3 D4 D5 D6 D7 D8 D9 D10 D11 D12 D13 D14 D15 CHANnel1 CHANnel2 CHANnel3 CHANnel4} | CHANnel2 |

**Return Format** The query returns D0, D1, D2, D3, D4, D5, D6, D7, D8, D9, D10, D11, D12, D13, D14, D15, CHAN1, CHAN2, CHAN3, or CHAN4.

**Example** :TRIGger:IIC:SDA CHANnel2 /\*Sets the data source to CHANnel2.\*/  
:TRIGger:IIC:SDA? /\*The query returns CHAN2.\*/\*

**:TRIGger:IIC:WHEN**

**Syntax** :TRIGger:IIC:WHEN <when>

:TRIGger:IIC:WHEN?

**Description** Sets or queries the trigger condition of I2C trigger.

| Parameter | Name   | Type     | Range                                                | Default |
|-----------|--------|----------|------------------------------------------------------|---------|
|           | <when> | Discrete | {START REStart STOP NACKnowledge ADDRess DATA ADATa} | START   |

- Remarks**
- START: indicates that the oscilloscope triggers when SCL is high level and SDA transitions from high level to low level.
  - REStart: indicates that the oscilloscope triggers when another start condition occurs before a stop condition.
  - STOP: indicates that the oscilloscope triggers when SCL is high level and SDA transitions from low level to high level.
  - NACKnowledge: indicates missing acknowledgment. The oscilloscope triggers when SDA is high level during the acknowledgment of the SCL bit.
  - ADDRess: indicates that the oscilloscope searches for the specified address and triggers on the read/write bit.
  - DATA: indicates that the oscilloscope searches for the specified data on the data line (SDA) and triggers on the clock line (SCL) of the jumping edge of the last bit of the data.
  - ADATa: indicates that the oscilloscope searches for the specified address and data, and then triggers when both the address and data meet the conditions.

**Return Format** The query returns STAR, REST, STOP, NACK, ADDR, DATA, or ADAT.

**Example** :TRIGger:IIC:WHEN REStart /\*Sets the trigger condition to REStart.\*/  
:TRIGger:IIC:WHEN? /\*The query returns REST.\*/\*

**:TRIGger:IIC:AWIDth**

**Syntax** :TRIGger:IIC:AWIDth <bits>

:TRIGger:IIC:AWIDth?

**Description** Sets or queries the address width of I2C trigger when the trigger condition is "ADDRess" or "ADATa".

| Parameter | Name   | Type     | Range    | Default |
|-----------|--------|----------|----------|---------|
|           | <bits> | Discrete | {7 8 10} | 7       |

**Return Format** The query returns 7, 8, or 10.

**Example** :TRIGger:IIC:AWIDth 10 /\*Sets the address width to 10.\*/  
:TRIGger:IIC:AWIDth? /\*The query returns 10.\*/\*

**:TRIGger:IIC:ADDRESS**

**Syntax** :TRIGger:IIC:ADDRESS <address>

:TRIGger:IIC:ADDRESS?

**Description** Sets or queries the address of I2C trigger when the trigger condition is "ADDRESS" or "ADATa".

| Parameter | Name  | Type    | Range                                              | Default |
|-----------|-------|---------|----------------------------------------------------|---------|
|           | <adr> | Integer | 0 to $2^n - 1$ : 0 to 127, 0 to 255, or 0 to 1,023 | 0       |

**Remarks** In the expression  $2^n - 1$ , n indicates the current address width.

**Return Format** The query returns an integer.

**Example** :TRIGger:IIC:ADDRESS 100 /\*Sets the address to 100.\*/  
:TRIGger:IIC:ADDRESS? /\*The query returns 100.\*/\*

**:TRIGger:IIC:DIRection**

**Syntax** :TRIGger:IIC:DIRection <direction>

:TRIGger:IIC:DIRection?

**Description** Sets or queries the data direction of I2C trigger when the trigger condition is "ADDRESS" or "ADATa".

| Parameter | Name  | Type     | Range               | Default |
|-----------|-------|----------|---------------------|---------|
|           | <dir> | Discrete | {READ WRITe RWRite} | WRITe   |

**Remarks** This command is unavailable when the address width is set to 8.

**Return Format** The query returns READ, WRIT, or RWR.

**Example** :TRIGger:IIC:DIRection RWRite /\*Sets the data direction to RWRite.\*/  
:TRIGger:IIC:DIRection? /\*The query returns RWR.\*/\*

**:TRIGger:IIC:DATA**

**Syntax** :TRIGger:IIC:DATA <data>

:TRIGger:IIC:DATA?

**Description** Sets or queries the data value of I2C trigger when the trigger condition is "DATA" or "ADATa".

| Parameter | Name   | Type    | Range             | Default |
|-----------|--------|---------|-------------------|---------|
|           | <data> | Integer | 0 to $2^{40} - 1$ | 0       |

**Remarks** The settable range of <data> is affected by the byte length. The maximum byte length can be set to 5, i.g. 40-bit binary data. Therefore, the range of <data> is from 0 to  $2^{40} - 1$ .

**Return Format** The query returns an integer.

**Example** :TRIGger:IIC:DATA 64 /\*Sets the data value to 64.\*/  
:TRIGger:IIC:DATA? /\*The query returns 64.\*/\*

**:TRIGger:IIC:CLeVel**

**Syntax** :TRIGger:IIC:CLeVel <level>

:TRIGger:IIC:CLeVel?

**Description** Sets or queries the trigger level of the clock line in I2C trigger. The unit is the same as that of the current amplitude.

| Parameter | Name    | Type | Range                                                            | Default |
|-----------|---------|------|------------------------------------------------------------------|---------|
|           | <level> | Real | (-5 × VerticalScale - OFFSet) to<br>(5 × VerticalScale - OFFSet) | 0 V     |

**Remarks** For VerticalScale, refer to the [:CHANnel<n>:SCALe](#) command; for OFFSet, refer to the [:CHANnel<n>:OFFSet](#) command.

**Return Format** The query returns the trigger level in scientific notation.

**Example** :TRIGger:IIC:CLeVel 0.16 /\*Sets the trigger level to 160 mV.\*/  
:TRIGger:IIC:CLeVel? /\*The query returns 1.600000E-1.\*/

**:TRIGger:IIC:DLeVel**

**Syntax** :TRIGger:IIC:DLeVel <level>

:TRIGger:IIC:DLeVel?

**Description** Sets or queries the trigger level of the data line in I2C trigger. The unit is the same as that of the current amplitude.

| Parameter | Name    | Type | Range                                                            | Default |
|-----------|---------|------|------------------------------------------------------------------|---------|
|           | <level> | Real | (-5 × VerticalScale - OFFSet) to<br>(5 × VerticalScale - OFFSet) | 0 V     |

**Remarks** For VerticalScale, refer to the [:CHANnel<n>:SCALe](#) command; for OFFSet, refer to the [:CHANnel<n>:OFFSet](#) command.

**Return Format** The query returns the trigger level in scientific notation.

**Example** :TRIGger:IIC:DLeVel 0.16 /\*Sets the trigger level to 160 mV.\*/  
:TRIGger:IIC:DLeVel? /\*The query returns 1.600000E-1.\*/

## :TRIGger:CAN (Option)

### Command List:

- ◆ [:TRIGger:CAN:BAUD](#)
- ◆ [:TRIGger:CAN:SOURce](#)
- ◆ [:TRIGger:CAN:STYPe](#)
- ◆ [:TRIGger:CAN:WHEN](#)
- ◆ [:TRIGger:CAN:SPOint](#)
- ◆ [:TRIGger:CAN:LEVel](#)

### :TRIGger:CAN:BAUD

**Syntax** :TRIGger:CAN:BAUD <baud>  
:TRIGger:CAN:BAUD?

**Description** Sets or queries the signal rate of CAN trigger. The unit is bps.

| Parameter | Name   | Type    | Range             | Default |
|-----------|--------|---------|-------------------|---------|
|           | <baud> | Integer | 10 kbps to 5 Mbps | 1 Mbps  |

**Remarks** If the baud rate is set to a value with "M", then "A" should be added at the end of the value. For example, if you send 5 M, you need to send 5 MA.

**Return Format** The query returns an integer ranging from 10 kbps to 5 Mbps.

**Example** :TRIGger:CAN:BAUD 125000 /\*Sets the signal rate to 125000 bps.\*/  
:TRIGger:CAN:BAUD? /\*The query returns 125000.\*/\*

### :TRIGger:CAN:SOURce

**Syntax** :TRIGger:CAN:SOURce <source>  
:TRIGger:CAN:SOURce?

**Description** Sets or queries the trigger source of CAN trigger.

| Parameter | Name     | Type     | Range                                                                                       | Default  |
|-----------|----------|----------|---------------------------------------------------------------------------------------------|----------|
|           | <source> | Discrete | {D0 D1 D2 D3 D4 D5 D6 D7 D8 D9 D10 D11 D12 D13 D14 D15 CHANnel1 CHANnel2 CHANnel3 CHANnel4} | CHANnel1 |

**Return Format** The query returns D0, D1, D2, D3, D4, D5, D6, D7, D8, D9, D10, D11, D12, D13, D14, D15, CHAN1, CHAN2, CHAN3, or CHAN4.

**Example** :TRIGger:CAN:SOURce CHANnel2 /\*Sets the trigger source to CHANnel2.\*/  
:TRIGger:CAN:SOURce? /\*The query returns CHAN2.\*/\*

**:TRIGger:CAN:STYPe**

**Syntax** :TRIGger:CAN:STYPe <stype>

:TRIGger:CAN:STYPe?

**Description** Sets or queries the signal type of CAN trigger.

| Parameter | Name    | Type     | Range                   | Default |
|-----------|---------|----------|-------------------------|---------|
|           | <stype> | Discrete | {H L RXTX DIFFerential} | H       |

**Return Format** The query returns H, L, RXTX, or DIFF.

- Remarks**
- H: indicates the actual CAN\_H differential bus signal.
  - L: indicates the actual CAN\_L differential bus signal.
  - RXTX: indicates the Receive or Transmit signal from the CAN bus transceiver.
  - DIFFerential: indicates the CAN differential bus signal connected to an analog channel by using a differential probe. Connect the probe's positive lead to the CAN\_H bus signal and connect the negative lead to the CAN\_L bus signal.

**Example** :TRIGger:CAN:STYPe L /\*Sets the signal type to CAN\_L differential bus signal.\*/  
:TRIGger:CAN:STYPe? /\*The query returns L.\*/

**:TRIGger:CAN:WHEN**

**Syntax** :TRIGger:CAN:WHEN <cond>

:TRIGger:CAN:WHEN?

**Description** Sets or queries the trigger condition of CAN trigger.

| Parameter | Name   | Type     | Range                                                                                           | Default |
|-----------|--------|----------|-------------------------------------------------------------------------------------------------|---------|
|           | <cond> | Discrete | {SOF EOF IDRemote OVERload IDFRame DATAfream IDData ERFReam ERANswer ERCheck ERFormat ERRandom} | SOF     |

- Remarks**
- SOF: indicates start of frame. It indicates that the oscilloscope triggers at the start of a data frame.
  - EOF: indicates end of frame. It indicates that the oscilloscope triggers at the end of a data frame.
  - IDRemote, OVERload, IDFRame, DATAfream, IDData: indicates frame type. It indicates that the oscilloscope triggers on the specified type of a frame.
  - ERFReam, ERANswer, ERCheck, ERFormat, ERRandom: indicates the frame error. It indicates that the oscilloscope triggers on the specified type of error frame.

**Return Format** The query returns SOF, EOF, IDR, OVER, IDFR, DAT, IDD, ERFR, ERAN, ERCH, ERF, or ERR.

**Example** TRIGger:CAN:WHEN EOF /\*Sets the trigger condition to EOF.\*/  
:TRIGger:CAN:WHEN? /\*The query returns EOF.\*/



**:TRIGger:CAN:SPOint**

**Syntax** :TRIGger:CAN:SPOint <spoint>

:TRIGger:CAN:SPOint?

**Description** Sets or queries the sample point position of CAN trigger (expressed in %).

| Parameter | Name     | Type    | Range    | Default |
|-----------|----------|---------|----------|---------|
|           | <spoint> | Integer | 10 to 90 | 50      |

**Remarks** Sample point is a point within a bit's time. The oscilloscope samples the bit level at this point. The sample point position is expressed as the ratio of "time from the bit start to the sample point" to "bit time", in %.

**Return Format** The query returns an integer ranging from 10 to 90.

**Example** :TRIGger:CAN:SPOint 60 /\*Sets the sample point position of CAN trigger to 60%.\*/  
:TRIGger:CAN:SPOint? /\*The query returns 60.\*/

**:TRIGger:CAN:LEVel**

**Syntax** :TRIGger:CAN:LEVel <level>

:TRIGger:CAN:LEVel?

**Description** Sets or queries the trigger level of CAN trigger. Its unit is the same as that of the current amplitude.

| Parameter | Name    | Type | Range                                                         | Default |
|-----------|---------|------|---------------------------------------------------------------|---------|
|           | <level> | Real | (-5 × VerticalScale - OFFSet) to (5 × VerticalScale - OFFSet) | 0 V     |

**Remarks** For VerticalScale, refer to the [:CHANnel<n>:SCALE](#) command; for OFFSet, refer to the [:CHANnel<n>:OFFSet](#) command.

**Return Format** The query returns the trigger level in scientific notation.

**Example** :TRIGger:CAN:LEVel 0.16 /\*Sets the trigger level to 160 mV.\*/  
:TRIGger:CAN:LEVel? /\*The query returns 1.600000E-1.\*/

## :TRIGger:SPI (Option)

### Command List:

- ◆ [:TRIGger:SPI:SCL](#)
- ◆ [:TRIGger:SPI:SDA](#)
- ◆ [:TRIGger:SPI:WHEN](#)
- ◆ [:TRIGger:SPI:WIDTh](#)
- ◆ [:TRIGger:SPI:DATA](#)
- ◆ [:TRIGger:SPI:TIMEout](#)
- ◆ [:TRIGger:SPI:SLOPe](#)
- ◆ [:TRIGger:SPI:CLEVel](#)
- ◆ [:TRIGger:SPI:DLEVel](#)
- ◆ [:TRIGger:SPI:SLEVel](#)
- ◆ [:TRIGger:SPI:MODE](#)
- ◆ [:TRIGger:SPI:CS](#)

### :TRIGger:SPI:SCL

**Syntax** :TRIGger:SPI:SCL <source>  
:TRIGger:SPI:SCL?

**Description** Sets or queries the channel source of the clock line of SPI trigger.

| Parameter | Name     | Type     | Range                                                                                       | Default  |
|-----------|----------|----------|---------------------------------------------------------------------------------------------|----------|
|           | <source> | Discrete | {D0 D1 D2 D3 D4 D5 D6 D7 D8 D9 D10 D11 D12 D13 D14 D15 CHANnel1 CHANnel2 CHANnel3 CHANnel4} | CHANnel1 |

**Return Format** The query returns D0, D1, D2, D3, D4, D5, D6, D7, D8, D9, D10, D11, D12, D13, D14, D15, CHAN1, CHAN2, CHAN3, or CHAN4.

**Example** :TRIGger:SPI:SCL CHANnel1  
/\*Sets the channel source of the clock line to CHANnel1.\*/  
:TRIGger:SPI:SCL?  
/\*The query returns CHAN1.\*/\*

### :TRIGger:SPI:SDA

**Syntax** :TRIGger:SPI:SDA <source>  
:TRIGger:SPI:SDA?

**Description** Sets or queries the channel source of the data line of SPI trigger.

| Parameter | Name     | Type     | Range                                                                                       | Default  |
|-----------|----------|----------|---------------------------------------------------------------------------------------------|----------|
|           | <source> | Discrete | {D0 D1 D2 D3 D4 D5 D6 D7 D8 D9 D10 D11 D12 D13 D14 D15 CHANnel1 CHANnel2 CHANnel3 CHANnel4} | CHANnel2 |

**Return** The query returns D0, D1, D2, D3, D4, D5, D6, D7, D8, D9, D10, D11, D12, D13, D14,

**Format** D15, CHAN1, CHAN2, CHAN3, or CHAN4.

**Example** :TRIGger:SPI:SDA CHANnel2 /\*Sets the channel source of the data line to CH2.\*/  
:TRIGger:SPI:SDA? /\*The query returns CHAN2.\*/

### :TRIGger:SPI:WHEN

**Syntax** :TRIGger:SPI:WHEN <when>  
:TRIGger:SPI:WHEN?

**Description** Sets or queries the trigger condition of SPI trigger.

| Parameter | Name   | Type     | Range        | Default |
|-----------|--------|----------|--------------|---------|
|           | <when> | Discrete | {CS TIMEout} | CS      |

**Remarks** When the trigger condition is "TIMEout", you can run the [:TRIGger:SPI:TIMEout](#) command to set the timeout value.

**Return Format** The query returns CS or TIM.

**Example** :TRIGger:SPI:WHEN TIMEout /\*Sets the trigger condition to TIMEout.\*/  
:TRIGger:SPI:WHEN? /\*The query returns TIM.\*/

### :TRIGger:SPI:WIDTH

**Syntax** :TRIGger:SPI:WIDTH <width>  
:TRIGger:SPI:WIDTH?

**Description** Sets or queries the data width of data channel in SPI trigger.

| Parameter | Name    | Type    | Range   | Default |
|-----------|---------|---------|---------|---------|
|           | <width> | Integer | 4 to 32 | 8       |

**Return Format** The query returns an integer.

**Example** :TRIGger:SPI:WIDTH 10 /\*Sets the data width to 10.\*/  
:TRIGger:SPI:WIDTH? /\*The query returns 10.\*/

### :TRIGger:SPI:DATA

**Syntax** :TRIGger:SPI:DATA <data>  
:TRIGger:SPI:DATA?

**Description** Sets or queries the data value of SPI trigger.

| Parameter | Name   | Type    | Range             | Default |
|-----------|--------|---------|-------------------|---------|
|           | <data> | Integer | 0 to $2^{32} - 1$ | 82      |

**Remarks** The range of the parameter <data> is related to the current data width. The available maximum data width is 32. Therefore, the range of <data> is from 0 to  $2^{32} - 1$ .

**Return Format** The query returns an integer.

**Example** :TRIGger:SPI:DATA 5 /\*Sets the data value to 5.\*/  
:TRIGger:SPI:DATA? /\*The query returns 5.\*/

**:TRIGger:SPI:TIMEout**

**Syntax** :TRIGger:SPI:TIMEout <time>

:TRIGger:SPI:TIMEout?

**Description** Sets or queries the timeout value when the trigger condition of SPI trigger is "Timeout". The default unit is s.

| Parameter | Name         | Type | Range        | Default   |
|-----------|--------------|------|--------------|-----------|
|           | <time_value> | Real | 8 ns to 10 s | 1 $\mu$ s |

**Return Format** The query returns the timeout value in scientific notation.

**Example** :TRIGger:SPI:TIMEout 0.001 /\*Sets the timeout value to 1 ms.\*/  
:TRIGger:SPI:TIMEout? /\*The query returns 1.000000E-3.\*/

**:TRIGger:SPI:SLOPe**

**Syntax** :TRIGger:SPI:SLOPe <slope>

:TRIGger:SPI:SLOPe?

**Description** Sets or queries the type of the clock edge of SPI trigger.

| Parameter | Name    | Type     | Range               | Default  |
|-----------|---------|----------|---------------------|----------|
|           | <slope> | Discrete | {POSitive NEGative} | POSitive |

- Remarks**
- POSitive: samples the SDA data on the rising edge of the clock.
  - NEGative: samples the SDA data on the falling edge of the clock.

**Return Format** The query returns POS or NEG.

**Example** :TRIGger:SPI:SLOPe POSitive /\*Sets the clock edge to POSitive.\*/  
:TRIGger:SPI:SLOPe? /\*The query returns POS.\*/

**:TRIGger:SPI:CLEVel**

**Syntax** :TRIGger:SPI:CLEVel <level>

:TRIGger:SPI:CLEVel?

**Description** Sets or queries the trigger level of the clock channel of SPI trigger. The unit is the same as that of the current amplitude.

| Parameter | Name    | Type | Range                                                         | Default |
|-----------|---------|------|---------------------------------------------------------------|---------|
|           | <level> | Real | (-5 × VerticalScale - OFFSet) to (6 × VerticalScale - OFFSet) | 0 V     |

**Remarks** For VerticalScale, refer to the [:CHANnel<n>:SCALE](#) command; for OFFSet, refer to the [:CHANnel<n>:OFFSet](#) command.

**Return Format** The query returns the trigger level in scientific notation.

**Example** :TRIGger:SPI:CLEVel 0.16 /\*Sets the trigger level to 160 mV.\*/  
:TRIGger:SPI:CLEVel? /\*The query returns 1.600000E-1.\*/

**:TRIGger:SPI:DLEVel**

**Syntax** :TRIGger:SPI:DLEVel <level>

:TRIGger:SPI:DLEVel?

**Description** Sets or queries the trigger level of the data channel of SPI trigger. The unit is the same as that of the current amplitude.

| Parameter | Name    | Type | Range                                                         | Default |
|-----------|---------|------|---------------------------------------------------------------|---------|
|           | <level> | Real | (-5 × VerticalScale - OFFSet) to (7 × VerticalScale - OFFSet) | 0 V     |

**Remarks** For VerticalScale, refer to the [:CHANnel<n>:SCALE](#) command; for OFFSet, refer to the [:CHANnel<n>:OFFSet](#) command.

**Return Format** The query returns the trigger level in scientific notation.

**Example** :TRIGger:SPI:DLEVel 0.16 /\*Sets the trigger level to 160 mV.\*/  
:TRIGger:SPI:DLEVel? /\*The query returns 1.600000E-1.\*/

**:TRIGger:SPI:SLEVel**

**Syntax** :TRIGger:SPI:SLEVel <level>

:TRIGger:SPI:SLEVel?

**Description** Sets or queries the trigger level of the CS channel of SPI trigger. The unit is the same as that of the current amplitude.

| Parameter | Name    | Type | Range                                                         | Default |
|-----------|---------|------|---------------------------------------------------------------|---------|
|           | <level> | Real | (-5 × VerticalScale - OFFSet) to (7 × VerticalScale - OFFSet) | 0 V     |

**Remarks** For VerticalScale, refer to the [:CHANnel<n>:SCALE](#) command; for OFFSet, refer to the [:CHANnel<n>:OFFSet](#) command.

**Return Format** The query returns the trigger level in scientific notation.

**Example** :TRIGger:SPI:SLEVel 0.16 /\*Sets the trigger level to 160 mV.\*/  
:TRIGger:SPI:SLEVel? /\*The query returns 1.600000E-1.\*/

**:TRIGger:SPI:MODE**

**Syntax** :TRIGger:SPI:MODE <mode>

:TRIGger:SPI:MODE?

**Description** Sets or queries the CS mode of SPI trigger when the trigger condition is "CS".

| Parameter | Name   | Type     | Range      | Default |
|-----------|--------|----------|------------|---------|
|           | <mode> | Discrete | {HIGH LOW} | LOW     |

**Return Format** The query returns HIGH or LOW.

**Example** :TRIGger:SPI:MODE LOW /\*Sets the CS mode to low level.\*/  
:TRIGger:SPI:MODE? /\*The query returns LOW.\*/

**:TRIGger:SPI:CS**

**Syntax** :TRIGger:SPI:CS <source>

:TRIGger:SPI:CS?

**Description** Sets or queries the source channel of the CS line when the trigger condition of SPI is set to CS.

| Parameter | Name     | Type     | Range                                                                                       | Default  |
|-----------|----------|----------|---------------------------------------------------------------------------------------------|----------|
|           | <source> | Discrete | {D0 D1 D2 D3 D4 D5 D6 D7 D8 D9 D10 D11 D12 D13 D14 D15 CHANnel1 CHANnel2 CHANnel3 CHANnel4} | CHANnel3 |

**Return Format** The query returns D0, D1, D2, D3, D4, D5, D6, D7, D8, D9, D10, D11, D12, D13, D14, D15, CHAN1, CHAN2, CHAN3, or CHAN4.

**Example** :TRIGger:SPI:CS CHANnel2

```
/*Sets source channel of the CS line to CHANnel2 when the trigger condition of SPI is set to CS.*/
```

```
:TRIGger:SPI:CS?
```

```
/*The query returns CHAN2.*/
```

## :TRIGger:FLEXray (Option)

### Command List:

- ◆ [:TRIGger:FLEXray:BAUD](#)
- ◆ [:TRIGger:FLEXray:LEVel](#)
- ◆ [:TRIGger:FLEXray:SOURce](#)
- ◆ [:TRIGger:FLEXray:WHEN](#)

### :TRIGger:FLEXray:BAUD

**Syntax** :TRIGger:FLEXray:BAUD <baud>  
:TRIGger:FLEXray:BAUD?

**Description** Sets or queries the signal rate of FlexRay trigger. The default unit is bps.

| Parameter | Name   | Type     | Range                      | Default      |
|-----------|--------|----------|----------------------------|--------------|
|           | <baud> | Discrete | {2500000 5000000 10000000} | 10000000 bps |

**Return Format** The query returns 2500000, 5000000, or 10000000.

**Example** :TRIGger:FLEXray:BAUD 5000000 /\*Sets the signal rate to 5000000 bps.\*/  
:TRIGger:FLEXray:BAUD? /\*The query returns 5000000.\*/\*

### :TRIGger:FLEXray:LEVel

**Syntax** :TRIGger:FLEXray:LEVel <level>  
:TRIGger:FLEXray:LEVel?

**Description** Sets or queries the trigger level of FlexRay trigger. Its unit is the same as that of the current amplitude.

| Parameter | Name    | Type | Range                                                         | Default |
|-----------|---------|------|---------------------------------------------------------------|---------|
|           | <level> | Real | (-5 × VerticalScale - OFFSet) to (5 × VerticalScale - OFFSet) | 0 V     |

**Remarks** For VerticalScale, refer to the [:CHANnel<n>:SCALE](#) command; for OFFSet, refer to the [:CHANnel<n>:OFFSet](#) command.

**Return Format** The query returns the trigger level in scientific notation.

**Example** :TRIGger:FLEXray:LEVel 0.16 /\*Sets the trigger level to 160 mV.\*/  
:TRIGger:FLEXray:LEVel? /\*The query returns 1.600000E-1.\*/\*

**:TRIGger:FLEXray:SOURce**

**Syntax** :TRIGger:FLEXray:SOURce <source>

:TRIGger:FLEXray:SOURce?

**Description** Sets or queries the trigger source of FlexRay trigger.

| Parameter | Name     | Type     | Range                                                                                       | Default  |
|-----------|----------|----------|---------------------------------------------------------------------------------------------|----------|
|           | <source> | Discrete | {D0 D1 D2 D3 D4 D5 D6 D7 D8 D9 D10 D11 D12 D13 D14 D15 CHANnel1 CHANnel2 CHANnel3 CHANnel4} | CHANnel1 |

**Return Format** The query returns D0, D1, D2, D3, D4, D5, D6, D7, D8, D9, D10, D11, D12, D13, D14, D15, CHAN1, CHAN2, CHAN3, or CHAN4.

**Example** :TRIGger:FLEXray:SOURce CHANnel2 /\*Sets the trigger source to CHANnel2.\*/  
:TRIGger:FLEXray:SOURce? /\*The query returns CHAN2.\*/\*

**:TRIGger:FLEXray:WHEN**

**Syntax** :TRIGger:FLEXray:WHEN <cond>

:TRIGger:FLEXray:WHEN?

**Description** Sets or queries the trigger condition of FLEXray trigger.

| Parameter | Name   | Type     | Range                    | Default |
|-----------|--------|----------|--------------------------|---------|
|           | <cond> | Discrete | {FRAMe SYMBol ERRor TSS} | FRAMe   |

- Remarks**
- FRAMe: triggers on the frame of the FlexRay bus.
  - SYMBol: triggers on the Channel Idle Delimiter (CID), Collision Avoidance Symbol (CAS), Media Access Test Symbol (MTS), and Wakeup Pattern (WUP) of the FlexRay bus.
  - ERRor: triggers when an error occurs to the FlexRay bus, including header CRC error and frame CRC error.
  - TSS: triggers on the transmission start sequence of the FlexRay bus.

**Return Format** The query returns FRAM, SYMB, ERR, or TSS.

**Example** :TRIGger:FLEXray:WHEN TSS /\*Sets the trigger condition to TSS.\*/  
:TRIGger:FLEXray:WHEN? /\*The query returns TSS.\*/\*



## :TRIGger:IIS (Option)

### Command List:

- ◆ [:TRIGger:IIS:ALIGnment](#)
- ◆ [:TRIGger:IIS:CLOCK:SLOPe](#)
- ◆ [:TRIGger:IIS:SOURce:CLOCK](#)
- ◆ [:TRIGger:IIS:SOURce:DATA](#)
- ◆ [:TRIGger:IIS:SOURce:WSElect](#)
- ◆ [:TRIGger:IIS:WHEN](#)
- ◆ [:TRIGger:IIS:AUDio](#)
- ◆ [:TRIGger:IIS:DATA](#)

### :TRIGger:IIS:ALIGnment

**Syntax** :TRIGger:IIS:ALIGnment <setting>  
:TRIGger:IIS:ALIGnment?

**Description** Sets or queries the alignment mode of the I2S trigger.

#### Parameter

| Name      | Type     | Range       | Default |
|-----------|----------|-------------|---------|
| <setting> | Discrete | {LJ RJ IIS} | IIS     |

#### Description

- RJ: data transmission (MSB first) is right-justified to the WS transition.
- LJ: data transmission (MSB first) begins at the edge of the WS transition.
- IIS: MSB (Most Significant Bit) of data for each sample is sent first, and LSB (Least Significant Bit) is sent last. The MSB appears on the SDA line one bit clock after the edge of the WS transition.

**Return Format** The query returns LJ, RJ, or IIS.

**Example** :TRIGger:IIS:ALIGnment LJ /\*Sets the alignment mode of I2S trigger to LJ.\*/  
:TRIGger:IIS:ALIGnment? /\*The query returns LJ.\*/

### :TRIGger:IIS:CLOCK:SLOPe

**Syntax** :TRIGger:IIS:CLOCK:SLOPe <slope>  
:TRIGger:IIS:CLOCK:SLOPe?

**Description** Sets or queries the type of the clock edge of I2S trigger.

#### Parameter

| Name    | Type     | Range               | Default  |
|---------|----------|---------------------|----------|
| <slope> | Discrete | {NEGative POSitive} | POSitive |

**Return Format** The query returns NEG or POS.

**Example** :TRIGger:IIS:CLOCK:SLOPe NEGative /\*Sets the clock edge to NEGative.\*/  
:TRIGger:IIS:CLOCK:SLOPe? /\*The query returns NEG.\*/

**:TRIGger:IIS:SOURce:CLOCK**

**Syntax** :TRIGger:IIS:SOURce:CLOCK <source>  
:TRIGger:IIS:SOURce:CLOCK?

**Description** Sets or queries the clock source of the I2S trigger.

| Parameter | Name | Type     | Range                                                                                           | Default  |
|-----------|------|----------|-------------------------------------------------------------------------------------------------|----------|
| <source>  |      | Discrete | {D0 D1 D2 D3 D4 D5 D6 D7 D8 D9 D10 D11 D12 D13 D14 D15 CHANnel1 CHANnel2 CHANnel3 CHANnel4 EXT} | CHANnel1 |

**Return Format** The query returns D0, D1, D2, D3, D4, D5, D6, D7, D8, D9, D10, D11, D12, D13, D14, D15, CHAN1, CHAN2, CHAN3, CHAN4, or EXT.

**Example** :TRIGger:IIS:SOURce:CLOCK CHANnel2 /\*Sets the clock source to CHANnel2.\*/  
:TRIGger:IIS:SOURce:CLOCK? /\*The query returns CHAN2.\*/\*

**:TRIGger:IIS:SOURce:DATA**

**Syntax** :TRIGger:IIS:SOURce:DATA <source>  
:TRIGger:IIS:SOURce:DATA?

**Description** Sets or queries the data source of the I2S trigger.

| Parameter | Name | Type     | Range                                                                                           | Default  |
|-----------|------|----------|-------------------------------------------------------------------------------------------------|----------|
| <source>  |      | Discrete | {D0 D1 D2 D3 D4 D5 D6 D7 D8 D9 D10 D11 D12 D13 D14 D15 CHANnel1 CHANnel2 CHANnel3 CHANnel4 EXT} | CHANnel1 |

**Return Format** The query returns D0, D1, D2, D3, D4, D5, D6, D7, D8, D9, D10, D11, D12, D13, D14, D15, CHAN1, CHAN2, CHAN3, CHAN4, or EXT.

**Example** :TRIGger:IIS:SOURce:DATA CHANnel2 /\*Sets the data source to CHANnel2.\*/  
:TRIGger:IIS:SOURce:DATA? /\*The query returns CHAN2.\*/\*

**:TRIGger:IIS:SOURce:WSElect**

**Syntax** :TRIGger:IIS:SOURce:WSElect <source>  
:TRIGger:IIS:SOURce:WSElect?

**Description** Sets or queries the audio channel of the I2S trigger.

| Parameter | Name | Type     | Range                                                                                           | Default  |
|-----------|------|----------|-------------------------------------------------------------------------------------------------|----------|
| <source>  |      | Discrete | {D0 D1 D2 D3 D4 D5 D6 D7 D8 D9 D10 D11 D12 D13 D14 D15 CHANnel1 CHANnel2 CHANnel3 CHANnel4 EXT} | CHANnel1 |

**Return Format** The query returns D0, D1, D2, D3, D4, D5, D6, D7, D8, D9, D10, D11, D12, D13, D14, D15, CHAN1, CHAN2, CHAN3, CHAN4, or EXT.

**Example** :TRIGger:IIS:SOURce:WSElect CHANnel2 /\*Sets the audio channel to CHANnel2.\*/  
:TRIGger:IIS:SOURce:WSElect? /\*The query returns CHAN2.\*/\*

**:TRIGger:IIS:WHEN**

**Syntax** :TRIGger:IIS:WHEN <operator>

:TRIGger:IIS:WHEN?

**Description** Sets or queries the trigger condition of I2S trigger.

| Parameter | Name       | Type     | Range                                                   | Default |
|-----------|------------|----------|---------------------------------------------------------|---------|
|           | <operator> | Discrete | {EQUal NOTequal LESSthan GREaterthan INRRange OUTRange} | EQUal   |

- Description**
- EQUal: triggers on when the channel's data value equals the set value.
  - NOTequal: triggers on when the channel's data value does not equal the set value.
  - LESSthan: triggers on when the channel's data value is smaller than the set value.
  - GREaterthan: triggers on when the channel's data value is greater than the set value.
  - INRRange: triggers on when the channel's data value is smaller than the set upper limit value and greater than the set lower limit value.
  - OUTRange: triggers on when the channel's data value is greater than the set upper limit value or smaller than the set lower limit value.

**Return Format** The query returns EQU, NOT, LESS, GRE, INR, or OUTR.

**Example** :TRIGger:IIS:WHEN NOTequal /\*Sets the trigger condition of I2S trigger to NOTequal.\*/

:TRIGger:IIS:WHEN? /\*The query returns NOT.\*/

**:TRIGger:IIS:AUDio**

**Syntax** :TRIGger:IIS:AUDio <audio>

:TRIGger:IIS:AUDio?

**Description** Sets or queries the audio state of I2S trigger.

| Parameter | Name    | Type     | Range               | Default |
|-----------|---------|----------|---------------------|---------|
|           | <audio> | Discrete | {RIGHt LEFT EITHer} | LEFT    |

- Description**
- RIGHt: data of the right channel.
  - LEFT: data of the left channel.
  - EITHer: data of either of the channel.

**Return Format** The query returns RIGH, LEFT, or EITH.

**Example** :TRIGger:IIS:AUDio RIGHt /\*Sets the I2S audio to RIGHt.\*/

:TRIGger:IIS:AUDio? /\*The query returns RIGH.\*/

**:TRIGger:IIS:DATA**

**Syntax** :TRIGger:IIS:DATA <data>

:TRIGger:IIS:DATA?

**Description** Sets or queries the data value of the I2S trigger.

| Parameter | Name   | Type    | Range           | Default |
|-----------|--------|---------|-----------------|---------|
|           | <data> | Integer | 0 to $2^{32}-1$ |         |

**Description** The settable range of <data> is affected by the byte length. The maximum byte length can be set to 4, i.g. 32-bit binary data. Therefore, the range of <data> is from 0 to  $2^{32} - 1$ .

**Return Format** The query returns an integer ranging from 0 to  $2^{32} - 1$ .

**Example** :TRIGger:IIS:DATA 10 /\*Sets the data value to 10.\*/  
:TRIGger:IIS:DATA? /\*The query returns 10.\*/

## :TRIGger:LIN (Option)

### Command List:

- ◆ [:TRIGger:LIN:SOURce](#)
- ◆ [:TRIGger:LIN:ID](#)
- ◆ [:TRIGger:LIN:BAUD](#)
- ◆ [:TRIGger:LIN:STANdard](#)
- ◆ [:TRIGger:LIN:SAMPlepoint](#)
- ◆ [:TRIGger:LIN:WHEN](#)
- ◆ [:TRIGger:LIN:LEVEl](#)

### :TRIGger:LIN:SOURce

**Syntax** :TRIGger:LIN:SOURce <source>  
:TRIGger:LIN:SOURce?

**Description** Sets or queries the trigger source of LIN trigger.

| Parameter | Name | Type     | Range                                                                                       | Default  |
|-----------|------|----------|---------------------------------------------------------------------------------------------|----------|
| <source>  |      | Discrete | {D0 D1 D2 D3 D4 D5 D6 D7 D8 D9 D10 D11 D12 D13 D14 D15 CHANnel1 CHANnel2 CHANnel3 CHANnel4} | CHANnel1 |

**Return Format** The query returns D0, D1, D2, D3, D4, D5, D6, D7, D8, D9, D10, D11, D12, D13, D14, D15, CHAN1, CHAN2, CHAN3, or CHAN4.

**Example** :TRIGger:LIN:SOURce CHANnel2 /\*Sets the trigger source to CHANnel2.\*/  
:TRIGger:LIN:SOURce? /\*The query returns CHAN2.\*/

### :TRIGger:LIN:ID

**Syntax** :TRIGger:LIN:ID <id>  
:TRIGger:LIN:ID?

**Description** Sets or queries the ID value of LIN trigger.

| Parameter | Name | Type | Range   | Default |
|-----------|------|------|---------|---------|
| <id>      |      | Real | 0 to 63 | 0       |

**Return Format** The query returns an integer ranging from 0 to 63.

**Example** :TRIGger:LIN:ID 4 /\*Sets the ID value of LIN trigger to 4.\*/  
:TRIGger:LIN:ID? /\*The query returns 4.\*/

**:TRIGger:LIN:BAUD**

**Syntax** :TRIGger:LIN:BAUD <baud>

:TRIGger:LIN:BAUD?

**Description** Sets or queries the baud rate of LIN trigger. The default unit is bps.

| Parameter | Name   | Type    | Range             | Default  |
|-----------|--------|---------|-------------------|----------|
|           | <baud> | Integer | 1 kbps to 20 Mbps | 9600 bps |

**Remarks** If the baud rate is set to a value with "M", then "A" should be added at the end of the value. For example, if you send 5 M, you need to send 5 MA.

**Return Format** The query returns an integer ranging from 1 kbps to 20 Mbps.

**Example** :TRIGger:LIN:BAUD 19200 /\*Sets the baud rate of LIN trigger to 19200 bps.\*/  
:TRIGger:LIN:BAUD? /\*The query returns 19200.\*/\*

**:TRIGger:LIN:STANdard**

**Syntax** :TRIGger:LIN:STANdard <std>

:TRIGger:LIN:STANdard?

**Description** Sets or queries the protocol version of LIN trigger.

| Parameter | Name  | Type     | Range        | Default |
|-----------|-------|----------|--------------|---------|
|           | <std> | Discrete | {1X 2X BOTH} | 1X      |

**Return Format** The query returns 1X, 2X, or BOTH.

**Example** :TRIGger:LIN:STANdard 2X /\*Sets the protocol version of LIN trigger to 2X.\*/  
:TRIGger:LIN:STANdard? /\*The query returns 2X.\*/\*

**:TRIGger:LIN:SAMPlEpoint**

**Syntax** :TRIGger:LIN:SAMPlEpoint <value>

:TRIGger:LIN:SAMPlEpoint?

**Description** Sets or queries the sample position of LIN trigger.

| Parameter | Name    | Type    | Range    | Default |
|-----------|---------|---------|----------|---------|
|           | <value> | Integer | 10 to 90 | 50      |

**Description** The sample position is expressed as the ratio of "time from the bit start to the sample point" to "bit time", in %.

**Return Format** The query returns an integer ranging from 10 to 90.

**Example** :TRIGger:LIN:SAMPlEpoint 40 /\*Sets the sample position of LIN trigger to 40%.\*/  
:TRIGger:LIN:SAMPlEpoint? /\*The query returns 40.\*/\*

**:TRIGger:LIN:WHEN**

**Syntax** :TRIGger:LIN:WHEN <when>

:TRIGger:LIN:WHEN?

**Description** Sets or queries the trigger condition of LIN trigger.

| Parameter | Name   | Type     | Range                                         | Default |
|-----------|--------|----------|-----------------------------------------------|---------|
|           | <when> | Discrete | {SYNCbreak ID DATA IDData SLEep WAKEup ERRor} | ID      |

- Description**
- SYNCbreak: triggers on the last bit of the sync field.
  - ID: triggers when the frames with the specified ID are found.
  - DATA: triggers when the data that meet the preset conditions are found.
  - IDData: triggers when the frames with the specified ID and data that meet the preset conditions are both found.
  - SLEep: triggers when the sleep frame is found.
  - WAKEup: triggers when the wakeup frame is found.
  - ERRor: triggers on the specified type of error frame.

**Return Format** The query returns SYNC, ID, DATA, IDD, SLE, WAK, or ERR.

**Example** :TRIGger:LIN:WHEN SYNCbreak /\*Sets the trigger condition to SYNCbreak.\*/  
:TRIGger:LIN:WHEN? /\*The query returns SYNC.\*/

**:TRIGger:LIN:LEVel**

**Syntax** :TRIGger:LIN:LEVel <level>

:TRIGger:LIN:LEVel?

**Description** Sets or queries the trigger level of LIN trigger. Its unit is the same as that of the current amplitude.

| Parameter | Name    | Type | Range                                                         | Default |
|-----------|---------|------|---------------------------------------------------------------|---------|
|           | <level> | Real | (-5 × VerticalScale - OFFSet) to (7 × VerticalScale - OFFSet) | 0 V     |

**Remarks** For VerticalScale, refer to the [:CHANnel<n>:SCALE](#) command; for OFFSet, refer to the [:CHANnel<n>:OFFSet](#) command.

**Return Format** The query returns the trigger level in scientific notation.

**Example** :TRIGger:LIN:LEVel 0.16 /\*Sets the trigger level to 160 mV.\*/  
:TRIGger:LIN:LEVel? /\*The query returns 1.600000E-1.\*/

## :TRIGger:M1553 (Option)

### Command List:

- ◆ [:TRIGger:M1553:SOURce](#)
- ◆ [:TRIGger:M1553:WHEN](#)
- ◆ [:TRIGger:M1553:POLarity](#)
- ◆ [:TRIGger:M1553:ALEVEL](#)
- ◆ [:TRIGger:M1553:BLEVEL](#)

### :TRIGger:M1553:SOURce

**Syntax** :TRIGger:M1553:SOURce <source>  
:TRIGger:M1553:SOURce?

**Description** Sets or queries the trigger source of M1553 trigger.

| Parameter | Name     | Type     | Range                                 | Default  |
|-----------|----------|----------|---------------------------------------|----------|
|           | <source> | Discrete | {CHANnel1 CHANnel2 CHANnel3 CHANnel4} | CHANnel1 |

**Return Format** The query returns CHAN1, CHAN2, CHAN3, or CHAN4.

**Example** :TRIGger:M1553:SOURce CHANnel2 /\*Sets the trigger source to CHANnel2.\*/  
:TRIGger:M1553:SOURce? /\*The query returns CHAN2.\*/\*

### :TRIGger:M1553:WHEN

**Syntax** :TRIGger:M1553:WHEN <when>  
:TRIGger:M1553:WHEN?

**Description** Sets or queries the trigger condition of M1553 trigger.

| Parameter | Name   | Type     | Range                             | Default   |
|-----------|--------|----------|-----------------------------------|-----------|
|           | <when> | Discrete | {SYNCbreak DATA CMD STATus ERRor} | SYNCbreak |

**Description**

- SYNCbreak: triggers on the specified sync type.
- DATA: triggers on the specified data word.
- CMD: triggers on the specified command word.
- STATus: triggers on the specified status word.
- ERRor: triggers on the specified error type.

**Return Format** The query returns SYNC, DATA, CMD, STAT, or ERR.

**Example** :TRIGger:M1553:WHEN CMD /\*Sets the trigger condition to CMD.\*/  
:TRIGger:M1553:WHEN? /\*The query returns CMD.\*/\*



**:TRIGger:M1553:POLarity**

**Syntax** :TRIGger:M1553:POLarity <polarity>

:TRIGger:M1553:POLarity?

**Description** Sets or queries the polarity of M1553 trigger.

| Parameter | Name       | Type     | Range               | Default  |
|-----------|------------|----------|---------------------|----------|
|           | <polarity> | Discrete | {POSitive NEGative} | POSitive |

**Return Format** The query returns POS or NEG.

**Example** :TRIGger:M1553:POLarity POSitive /\*Sets the polarity of M1553 trigger to POSitive.\*/  
:TRIGger:M1553:POLarity? /\*The query returns POS.\*/

**:TRIGger:M1553:ALEVel**

**Syntax** :TRIGger:M1553:ALEVel <level>

:TRIGger:M1553:ALEVel?

**Description** Sets or queries the upper limit of the trigger level of M1553 trigger. The unit is the same as that of the current amplitude.

| Parameter | Name    | Type | Range                                          | Default |
|-----------|---------|------|------------------------------------------------|---------|
|           | <level> | Real | Lower limit to<br>(5 × VerticalScale - OFFSet) | 0 V     |

**Remarks** For VerticalScale, refer to the [:CHANnel<n>:SCALE](#) command; for OFFSet, refer to the [:CHANnel<n>:OFFSet](#) command.

**Return Format** The query returns the upper limit of the trigger level in scientific notation.

**Example** :TRIGger:M1553:ALEVel 0.16 /\*Sets the upper limit of the trigger level to 160 mV.\*/  
:TRIGger:M1553:ALEVel? /\*The query returns 1.600000E-1.\*/

**:TRIGger:M1553:BLEVel**

**Syntax** :TRIGger:M1553:BLEVel <level>

:TRIGger:M1553:BLEVel?

**Description** Sets or queries the lower limit of the trigger level of M1553 trigger. The unit is the same as that of the current amplitude.

| Parameter | Name    | Type | Range                                           | Default |
|-----------|---------|------|-------------------------------------------------|---------|
|           | <level> | Real | (-5 × VerticalScale - OFFSet) to<br>upper limit | 0 V     |

**Remarks** For VerticalScale, refer to the [:CHANnel<n>:SCALE](#) command; for OFFSet, refer to the [:CHANnel<n>:OFFSet](#) command.

**Return Format** The query returns the lower limit of the trigger level in scientific notation.

**Example** :TRIGger:M1553:BLEVel 0.05 /\*Sets the lower limit of the trigger level to 50 mV.\*/  
:TRIGger:M1553:BLEVel? /\*The query returns 5.000000E-2.\*/

## :WAVEform Commands

The :WAVEform commands are used to read waveform data and relevant settings. The :WAVEform:MODE command is used to set the reading mode of waveform data. In different modes, the definitions for the parameters are different, as shown in Figure 2-1 and 2-2.

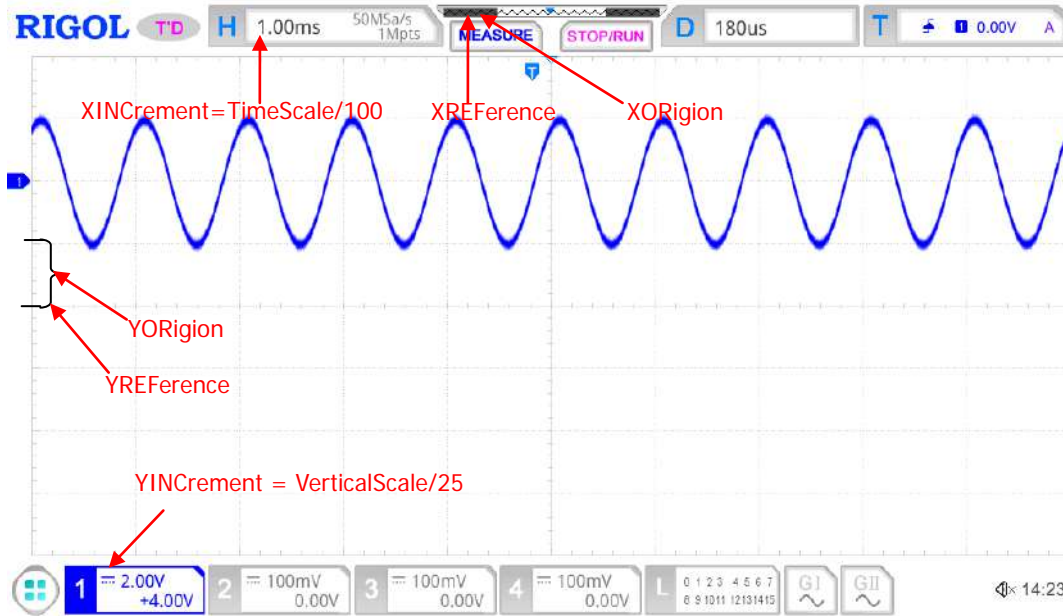

Figure 2-1 Parameter Definitions in NORMAL Mode

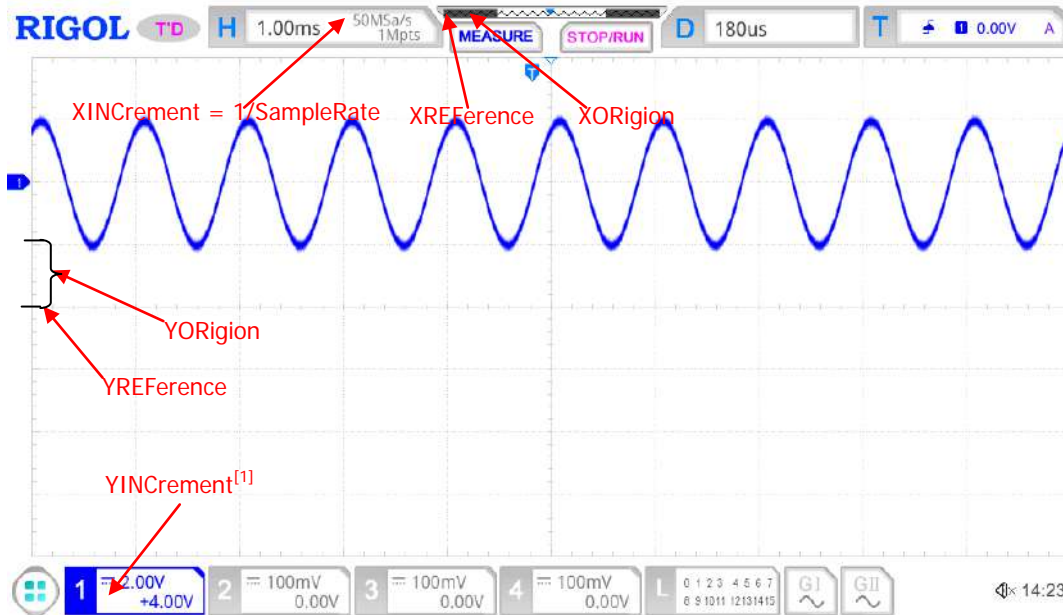

Figure 2-2 Parameter Definitions in RAW Mode

**Note<sup>[1]</sup>:** In RAW mode, YINcrement and Verticalscale of the memory waveforms are related to the currently selected Verticalscale.

**Command List:**

- ◆ [:WAVeform:SOURce](#)
- ◆ [:WAVeform:MODE](#)
- ◆ [:WAVeform:FORMat](#)
- ◆ [:WAVeform:POINts](#)
- ◆ [:WAVeform:DATA?](#)
- ◆ [:WAVeform:XINCrement?](#)
- ◆ [:WAVeform:XORigin?](#)
- ◆ [:WAVeform:XREFerence?](#)
- ◆ [:WAVeform:YINCrement?](#)
- ◆ [:WAVeform:YORigin?](#)
- ◆ [:WAVeform:YREFerence?](#)
- ◆ [:WAVeform:START](#)
- ◆ [:WAVeform:STOP](#)
- ◆ [:WAVeform:PREamble?](#)

**:WAVeform:SOURce**

**Syntax** :WAVeform:SOURce <source>

:WAVeform:SOURce?

**Description** Sets or queries the source channel of waveform data reading.

| Parameter | Name | Type     | Range                                                                                                               | Default  |
|-----------|------|----------|---------------------------------------------------------------------------------------------------------------------|----------|
| <source>  |      | Discrete | {D0 D1 D2 D3 D4 D5 D6 D7 D8 D9 D10 D11 D12 D13 D14 D15 CHANnel1 CHANnel2 CHANnel3 CHANnel4 MATH1 MATH2 MATH3 MATH4} | CHANnel1 |

- Remarks**
- When the channel source is set to MATH1-MATH4, [:WAVeform:MODE](#) can only select the NORMAL mode.
  - When the channel source is set to a digital channel, the query command [:WAVeform:DATA?](#) always returns the waveform data in byte format. If the command reads the screen waveform data, it returns the signal status of the currently selected channel source. One waveform point occupies 1 byte (8 bits). If the command reads the memory waveform data, it returns the signal status of the channel group where the currently selected channel sources reside. 1 byte represents the status of one group of digital signals.

**Return Format** The query returns D0, D1, D2, D3, D4, D5, D6, D7, D8, D9, D10, D11, D12, D13, D14, D15, CHAN1, CHAN2, CHAN3, CHAN4, MATH1, MATH2, MATH3, or MATH4.

**Example** :WAVeform:SOURce CHANnel2 /\*Sets the channel source to CHANnel2.\*/  
:WAVeform:SOURce? /\*The query returns CHAN2.\*/

## :WAVeform:MODE

**Syntax** :WAVeform:MODE <mode>

:WAVeform:MODE?

**Description** Sets or queries the mode of the [:WAVeform:DATA?](#) command in reading data.

| Parameter | Name   | Type     | Range                | Default |
|-----------|--------|----------|----------------------|---------|
|           | <mode> | Discrete | {NORMal MAXimum RAW} | NORMal  |

- Remarks**
- NORMAL: reads the waveform data currently displayed on the screen.
  - MAXimum: reads the waveform data displayed on the screen when the oscilloscope is in the Run state; reads the waveform data in the internal memory when the oscilloscope is in the Stop state.
  - RAW: reads the waveform data in the internal memory. Note: The data in the internal memory can only be read when the oscilloscope is in the Stop state. You are not allowed to operate the instrument when it is reading data.
  - When the channel source is set to MATH, only the NORMal mode is valid.

**Return Format** The query returns NORM, MAX, or RAW.

**Example** :WAVeform:MODE RAW /\*Sets the reading mode of waveform data to RAW.\*/  
:WAVeform:MODE? /\*The query returns RAW.\*/

## :WAVeform:FORMat

**Syntax** :WAVeform:FORMat <format>

:WAVeform:FORMat?

**Description** Sets or queries the return format of the waveform data.

| Parameter | Name     | Type     | Range             | Default |
|-----------|----------|----------|-------------------|---------|
|           | <format> | Discrete | {WORD BYTE ASCii} | BYTE    |

- Remarks**
- WORD: Each waveform point occupies 2 bytes (16 bits). The lower 8 bits are valid and the higher 8 bits are 0.
  - BYTE: Each waveform point occupies one byte (8 bits).
  - ASCii: The query returns the actual voltage value of each waveform point in scientific notation; and the voltage values are separated by commas.

**Return Format** The query returns WORD, BYTE, or ASC.

**Example** :WAVeform:FORMat WORD /\*Sets the returned format of waveform data to WORD.\*/  
:WAVeform:FORMat? /\*The query returns WORD.\*/

## :WAVeform:POINTs

**Syntax** :WAVeform:POINTs <point>

:WAVeform:POINTs?

**Description** Sets or queries the number of the waveform points to be read.

| Parameter | Name    | Type    | Range                   | Default |
|-----------|---------|---------|-------------------------|---------|
|           | <point> | Integer | Refer to <b>Remarks</b> | ---     |

**Remarks** The range of <point> is related to the current reading mode of the waveform data.

- NORMal: 1 to 1,000
- RAW: 1 to the current maximum memory depth
- MAXimum: 1 to the number of effective points on the current screen

**Return Format** The query returns the number of waveform points in integer.

## :WAVeform:DATA?

**Syntax** :WAVeform:DATA?

**Description** Reads the waveform data.

- Remarks**
- Procedures of reading the waveform data on the screen:
    - S1. :WAV:SOUR CHAN1 Sets the channel source to CH1.
    - S2. :WAV:MODE NORMal Sets the waveform reading mode to NORMal.
    - S3. :WAV:FORM BYTE Sets the return format of the waveform data to BYTE.
    - S4. :WAV:DATA? Reads the waveform data on the screen.
  - Procedures of reading the waveform data in the internal memory:
    - S1. :WAV:SOUR CHAN1 Sets the channel source to CH1.
    - S2. :WAV:MODE RAW Sets the waveform reading mode to RAW.
    - S3. :WAV:FORM BYTE Sets the return format of the waveform data to BYTE.
    - S4. :WAVeform:POINTs 10000 Reads the number of memory waveform points to 10,000.
    - S5. :WAV:DATA? Reads the waveform data from the internal memory.

**Return Format**

- The return format is related to the return format of the currently selected waveform data.  
 WORD or BYTE format: The read data format is TMC header + waveform data points + end identifier. The TMC header is in the form of #NXXXXXX. Wherein, # is the identifier, N indicates the N bytes following it. The length of the waveform data points is in the form of ASCII. The end identifier is used to indicate the ending of communication. For example, the data read for one time is #9000001000XXXX. It indicates that 9 bytes are used to describe the data length. 000001000 indicates the length of waveform data, i.g. 1,000 bytes.  
 ASCII: The query returns the actual voltage value of each waveform point in scientific notation; and the voltage values are separated by commas.  
**Note:** When the channel source of waveform data reading is set to a digital channel, the query command always returns the waveform data in BYTE format. If the command reads the screen waveform data, it returns the signal status of the

currently selected channel source. One waveform point occupies 1 byte (8 bits). If the command reads the memory waveform data, it returns the signal status of the channel group where the currently selected channel sources reside. 1 byte represents the status of one group of digital signals.

- When the waveform data in the internal memory are read in batches, the waveform data returned each time might be the data in one area of the internal memory. In "WORD" or "BYTE" return format, each returned data in blocks contain the TMC data block header. Waveform data in two adjacent data blocks are consecutive.

## :WAVeform:XINCrement?

**Syntax** :WAVeform:XINCrement?

**Description** Queries the time interval between two neighboring points of the currently selected channel source in the X direction.

- Remarks**
- The returned value is related to the current data reading mode:  
In NORMAl mode, XINCrement = TimeScale/100.  
In RAW mode, XINCrement = 1/SampleRate.  
In MAX mode, XINCrement = TimeScale/100 when the oscilloscope is in the Run state; XINCrement = 1/SampleRate when the oscilloscope is in the Stop state.
  - The unit is related to the current channel source.

**Return Format** The query returns the time difference in scientific notation.

## :WAVeform:XORigin?

**Syntax** :WAVeform:XORigin?

**Description** Queries the start time of the waveform data of the currently selected channel source in the X direction.

- Remarks**
- The returned value is related to the current data reading mode:  
In NORMAl mode, the query returns the start time of the waveform data displayed on the screen.  
In RAW mode, the query returns the start time of the waveform data in the internal memory.  
In MAX mode, the query returns the start time of the waveform data displayed on the screen when the instrument is in the RUN state; the query returns the start time of the waveform data in the internal memory when the instrument is in the Stop state.
  - The unit is related to the current channel source.

**Return Format** The query returns the time value in scientific notation.

## :WAVeform:XREFerence?

**Syntax** :WAVeform:XREFerence?

**Description** Queries the reference time of the waveform points of the currently selected channel source in the X direction.

**Return Format** The query returns 0 (namely the first waveform point on the screen or in the internal memory).

## :WAVeform:YINCrement?

**Syntax** :WAVeform:YINCrement?

**Description** Queries the unit voltage of the current channel in the Y axis. Its unit is the same as that of the current amplitude.

**Remarks** The returned value is related to the current data reading mode:  
In NORMal mode,  $YINCrement = VerticalScale/25$ .  
In RAW mode, YINCrement and VerticalScale of the memory waveforms are related to the currently selected VerticalScale.  
In Max mode,  $YINCrement = VerticalScale/25$  when the instrument is in the RUN state; YINCrement is related to the VerticalScale of the internal waveform and the currently selected VerticalScale when the instrument is in the Stop state.

**Return Format** The query returns the unit voltage in scientific notation.

## :WAVeform:YORigin?

**Syntax** :WAVeform:YORigin?

**Description** Queries the vertical offset relative to the vertical reference position of the currently selected channel source in the Y direction.

**Remarks** The returned value is related to the current data reading mode:  
In NORMal mode,  $YORigin = VerticalOffset/YINCrement$ .  
In RAW mode, YORigin is related to the VerticalScale of the memory waveforms and the currently selected VerticalScale.  
In Max mode,  $YORigin = VerticalOffset/YINCrement$  when the instrument is in the RUN state; YORigin is related to the VerticalScale of the internal waveform and the currently selected VerticalScale when the instrument is in the Stop state.

**Return Format** The query returns an integer.

## :WAVeform:YREFerence?

**Syntax** :WAVeform:YREFerence?

**Description** Queries the vertical reference position of the currently selected channel source in the Y direction.

**Remarks** The returned value is a fixed one 128.

**Return Format** The query returns 128.

**:WAVEform:START**

**Syntax** :WAVEform:START <sta>

:WAVEform:START?

**Description** Sets or queries the start position of waveform data reading.

| Parameter | Name  | Type    | Range                                                                                                                              | Default |
|-----------|-------|---------|------------------------------------------------------------------------------------------------------------------------------------|---------|
|           | <sta> | Integer | NORMAL: 1 to 1,000<br>MAX: 1 to the number of effective points on the current screen<br>RAW: 1 to the current maximum memory depth | 1       |

**Remarks** When reading the waveform data in the internal memory, the actual settable ranges of the start point and stop point of a reading operation are related to the memory depth of the oscilloscope and the return format of the waveform data currently selected.

**Return Format** The query returns an integer.

**Example** :WAVEform:START 100 /\*Sets the start point to 100.\*/  
:WAVEform:START? /\*The query returns 100.\*/\*

**:WAVEform:STOP**

**Syntax** :WAVEform:STOP <stop>

:WAVEform:STOP?

**Description** Sets or queries the stop position of waveform data reading.

| Parameter | Name   | Type    | Range                                                                                                                              | Default |
|-----------|--------|---------|------------------------------------------------------------------------------------------------------------------------------------|---------|
|           | <stop> | Integer | NORMAL: 1 to 1,000<br>MAX: 1 to the number of effective points on the current screen<br>RAW: 1 to the current maximum memory depth | 1,000   |

**Remarks** When reading the waveform data in the internal memory, the actual settable ranges of the start point and stop point of a reading operation are related to the memory depth of the oscilloscope and the return format of the waveform data currently selected.

**Return Format** The query returns an integer.

**Example** :WAVEform:STOP 500 /\*Sets the stop point to 500.\*/  
:WAVEform:STOP? /\*The query returns 500.\*/\*

**:WAVEform:PREamble?**

**Syntax** :WAVEform:PREamble?

**Description** Queries all the waveform parameters.

**Return Format** The query returns 10 waveform parameters, separated by commas.

<format>,<type>,<points>,<count>,<xincrement>,<xorigin>,<xreference>,<yincrement>,<yorigin>,<yreference>

Wherein,

<format>: indicates 0 (BYTE), 1 (WORD), or 2 (ASC).



<type>: indicates 0 (NORMal), 1 (MAXimum), or 2 (RAW).  
<points>: an integer ranging from 1 to 50,000,000.  
<count>: indicates the number of averages in the average sample mode. The value of <count> parameter is 1 in other modes.  
<xincrement>: indicates the time difference between two neighboring points in the X direction.  
<xorigin>: indicates the start time of the waveform data in the X direction.  
<xreference>: indicates the reference time of the waveform data in the X direction.  
<yincrement>: indicates the step value of the waveforms in the Y direction.  
<yorigin>: indicates the vertical offset relative to the "Vertical Reference Position" in the Y direction.  
<yreference>: indicates the vertical reference position in the Y direction.

**Example** :WAVEform:PREamble?

```
/*The query returns  
0,0,1000,1,1.000000E-8,-5.000000E-6,0.000000E-12,4.000000E-03,0,128.*/
```



## Chapter 3 Programming Examples

This chapter illustrates how to control the MSO8000 series digital oscilloscope by programming in Excel, LabVIEW, Visual Basic, and Visual C++. These instances are programmed based on Virtual Instrument Software Architecture (VISA) library.

### Contents in this chapter:

- ◆ [Programming Preparations](#)
- ◆ [Excel Programming Example](#)
- ◆ [LabVIEW Programming Example](#)
- ◆ [Visual Basic Programming Example](#)
- ◆ [Visual C++ Programming Example](#)

## Programming Preparations

Before programming, you need to prepare the following tasks:

Install Ultra Sigma (PC) software. You can log in to the **RIGOL** official website ([www.rigol.com](http://www.rigol.com)) to download the software. Then install the software according to the installation wizard. After Ultra Sigma is installed successfully, NI-VISA library will be completely installed automatically. In this manual, the default installation path is C:\Program Files\IVI Foundation\VISA.

In the manual, the oscilloscope communicates with the PC via the USB interface. Connect the USB Device interface on the rear panel of the oscilloscope to the PC by using the USB cable. After the oscilloscope is properly connected to the PC, power on the instrument to start it. In this case, "Found New Hardware Wizard" dialog box appears on the PC. Please install "USB Test and Measurement Device (IVI)" according to the instructions.

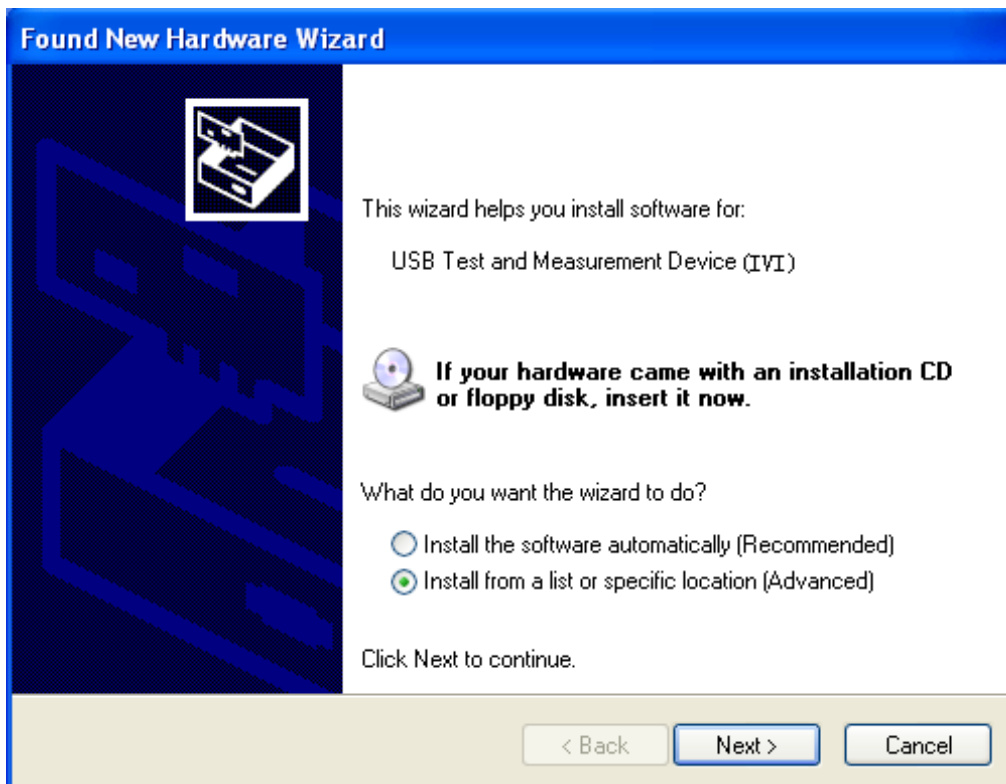

By now, the programming preparations are complete. The following parts will make a detailed introduction about the programming examples in Excel, LabVIEW, Visual Basic, and Visual C++.

## Excel Programming Example

**Program used in this instance:** Microsoft Excel 2007

**Function realized in this example:** send the \*IDN? command and read the instrument information.

1. Open a new Macro-enabled Excel file and name it "MSO8000\_Demo\_Excel.xlsm".
2. Run the MSO8000\_Demo\_Excel.xlsm file. Click **File**→**Options** at the upper-left corner of the Excel file to open the interface as shown in the figure below. Click **Customize Ribbon** at the left, check **Developer** and click **OK**. At this point, the Excel menu bar displays the **Developer** menu.

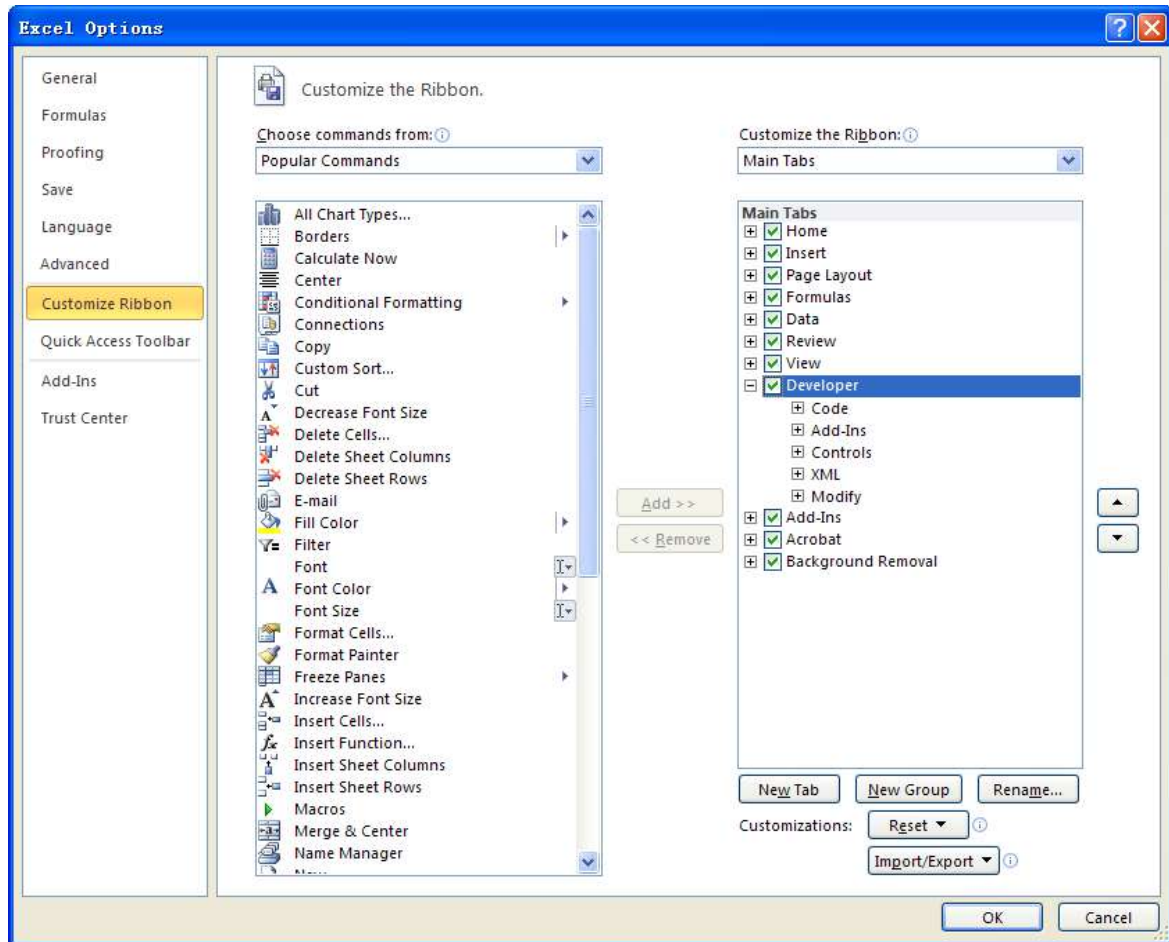

3. Enter a device resource descriptor into a cell of the file as shown in the figure below. For example, the device resource descriptor is USB0::0x1AB1::0x0514::DS8B200112345::INSTR. Input it into SHEET1.CELLS(1,2) (i.g. the B1 cell in Sheet1). Click the **Developer** menu and select the **Visual Basic** option to open the Microsoft Visual Basic.

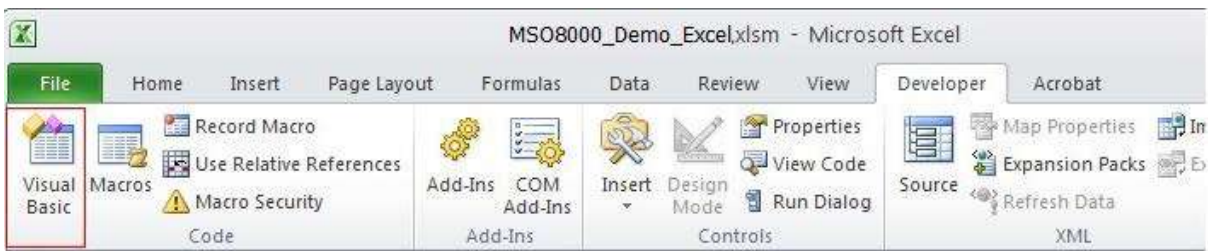
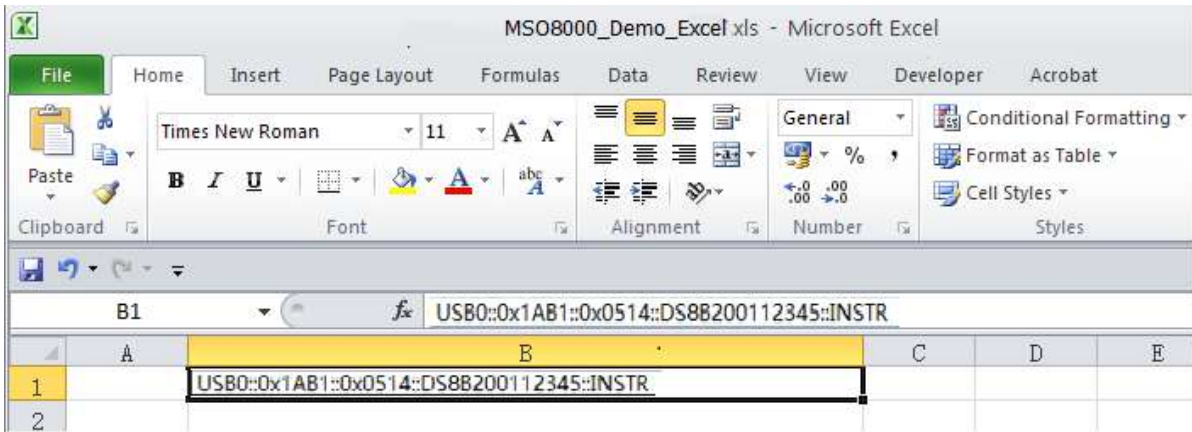

4. Click **Tools(T)** in the Microsoft Visual Basic menu bar and select **References**.



In the displayed dialog box, select **VISA Library**, and click **OK** to refer to VISA Library.

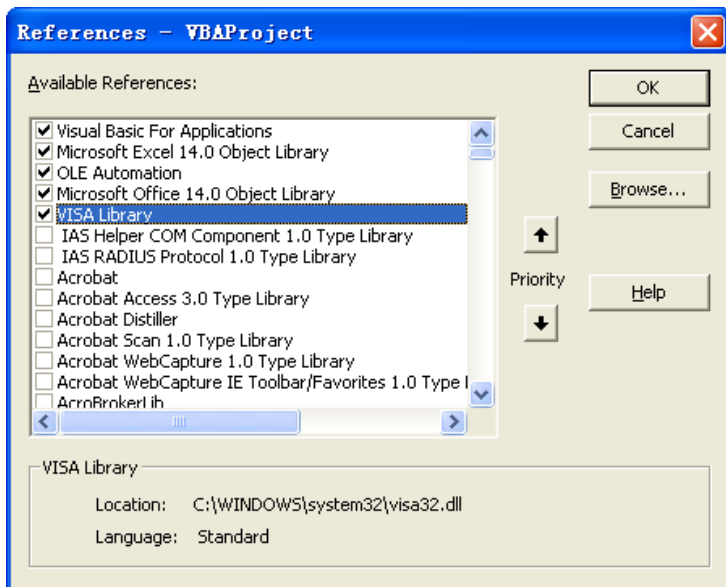

**Remarks:**  
If you cannot find VISA Library in the left section of the above dialog box, please follow the method below to find it.  
(1) Make sure that your PC has installed the NI-VISA library.  
(2) Click **Browse...** at the right section to search visa32.dll from C:\WINDOWS\system32, as shown in the figure below.

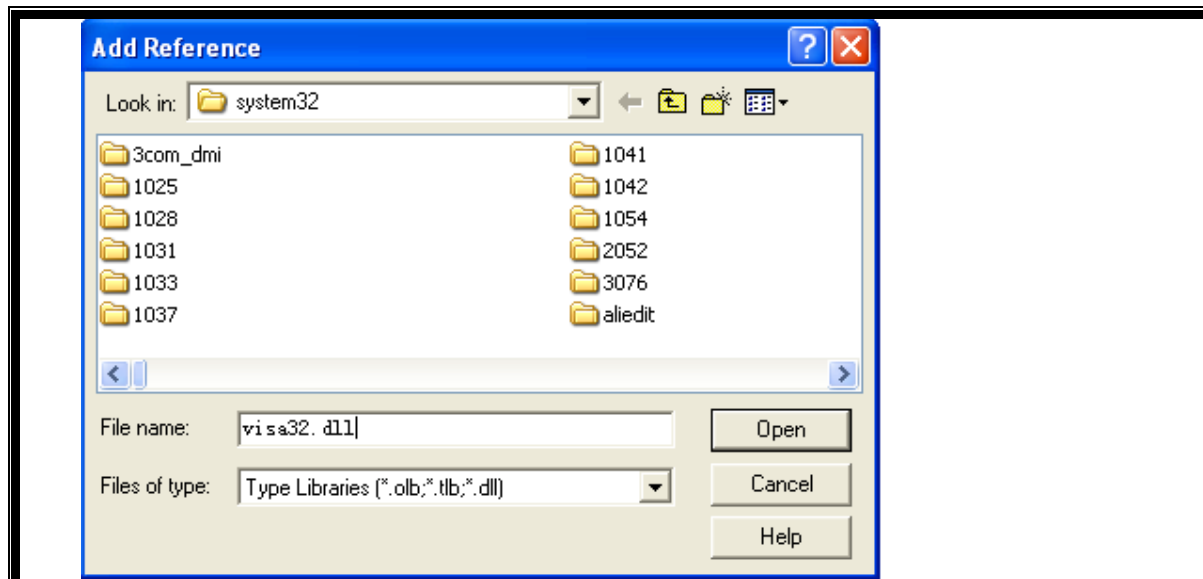

- Click **View Code** under **Developer** menu to enter the interface of Microsoft Visual Basic. Add the following codes and save it.

**Note:** If the Excel file created in Step 2 does not enable the Macros, a prompt message "The following features cannot be saved in macro-free workbooks" will be displayed. In this case, please save the file as a macro-enabled file type (filename with a suffix of ".xlsm").

Sub QueryIdn()

```
Dim viDefRm As Long
Dim viDevice As Long
Dim viErr As Long
Dim cmdStr As String
Dim idnStr As String * 128
Dim ret As Long
```

'Turn on the device, and the device resource descriptor is in CELLS(1,2) of SHEET1'  
 viErr = visa.viOpenDefaultRM(viDefRm)  
 viErr = visa.viOpen(viDefRm, Sheet1.Cells(1, 2), 0, 5000, viDevice)

'Send request, read the data, and the return value is in CELLS(2,2) of SHEET1'  
 cmdStr = "\*IDN?"  
 viErr = visa.viWrite(viDevice, cmdStr, Len(cmdStr), ret)  
 viErr = visa.viRead(viDevice, idnStr, 128, ret)  
 Sheet1.Cells(2, 2) = idnStr

'Turn off the device'  
 visa.viClose (viDevice)  
 visa.viClose (viDefRm)

End Sub

- Add the button control. Click **Insert** under the **Developer** menu, and select a button control under the **Form Controls** menu item and put it into the Excel cell. At this time, the **Macro** dialog box is displayed, select "Sheet1.QueryIdn" and click **OK**.

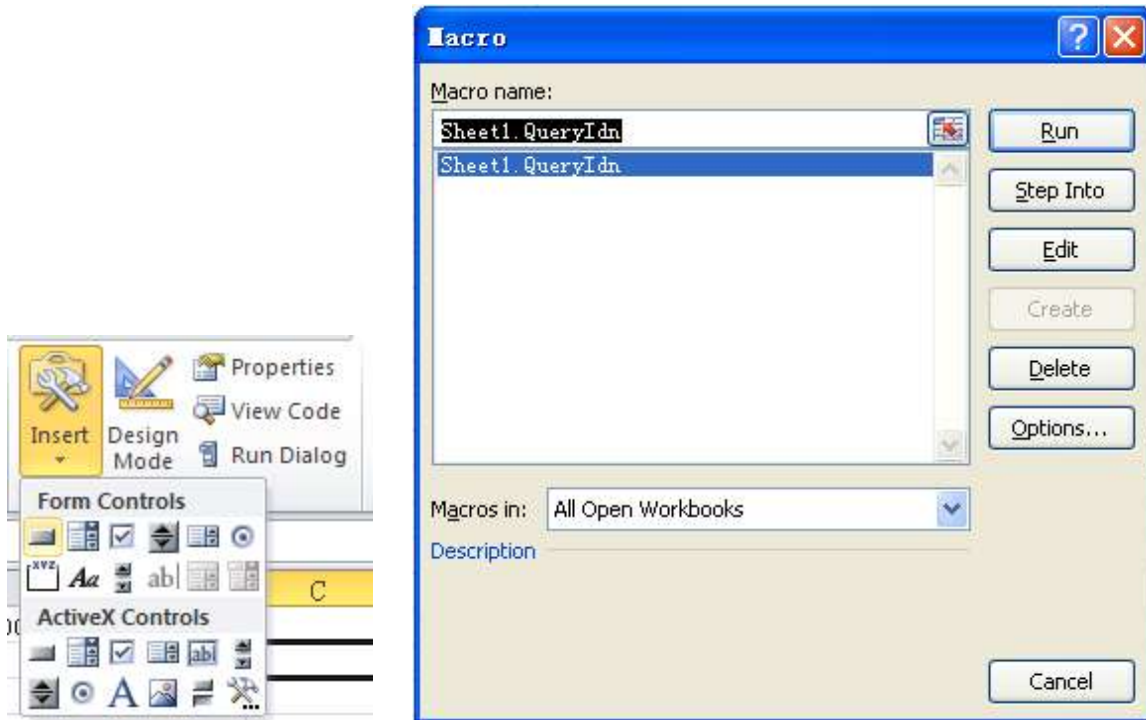

The default name of the button is "Button1". Right-click the button and select **Edit Text** in the pop-up menu to change the button name to "\*IDN?".

7. Click the "\*IDN?" button to send request and read data. The returned value is in CELLS(2,2) of SHEET1.



## LabVIEW Programming Example

Program used in this instance: LabVIEW2010

Function realized in this example: read the waveform data of CH1 on the screen.

1. Run LabVIEW, create a VI file and name it as MSO8000\_Demo.
2. Add controls and create the front panel as shown in the figure below.

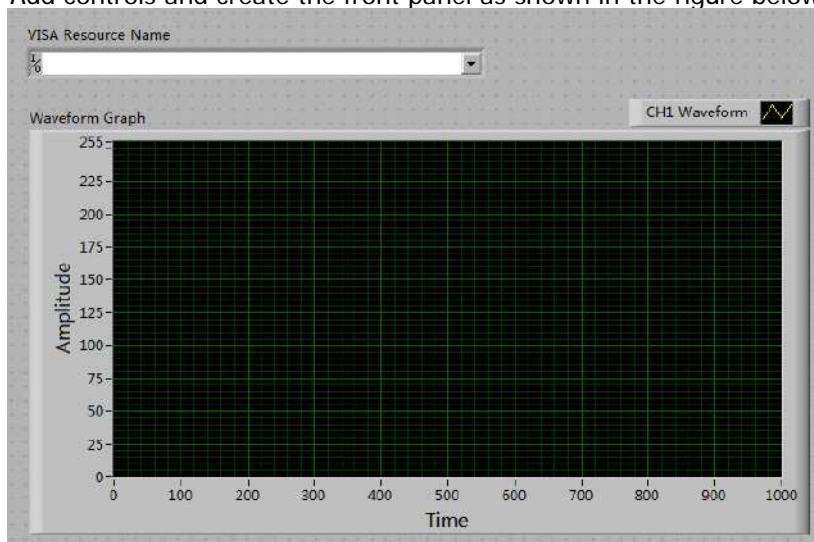

3. Open the **Block Diagram** interface. Click **Instrument I/O** → **VISA**. Add the following functions: VISA Open, VISA Read, VISA Write, and VISA Close.

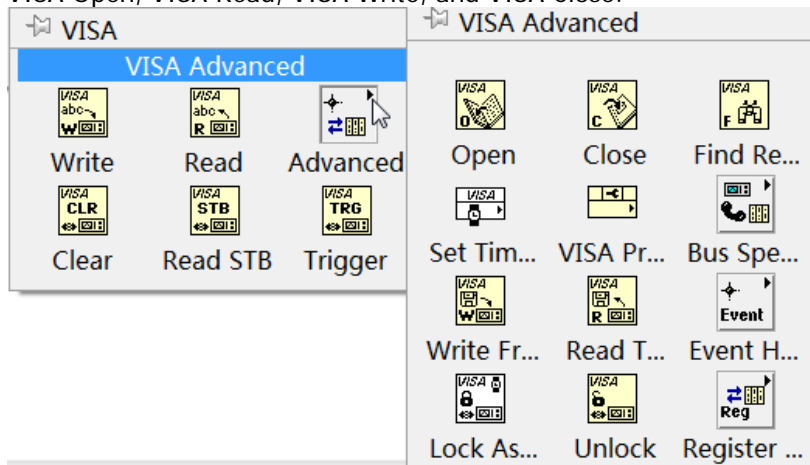

4. Change the default **Asynchronous** to **Synchronous**.

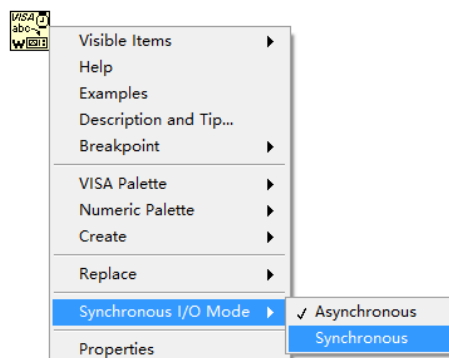

- Connect the **VISA resource name** with the **VISA Open**. Then, connect the VISA resource name outputs of all the functions with the **VISA resource name** and connect the error output with the error input, as shown in the figure below.

VISA Resource Name



- Add string constant in the write buffer areas of the VISA Write function and input the following instructions in the figure below. Waveform data is read through the VISA Read function which requires users to input the total number of bytes to be read. In this example, the total number of bytes of waveform data to be read is less than 2048. Use the VISA Close function to close the VISA resource after the VISA operation is finished.

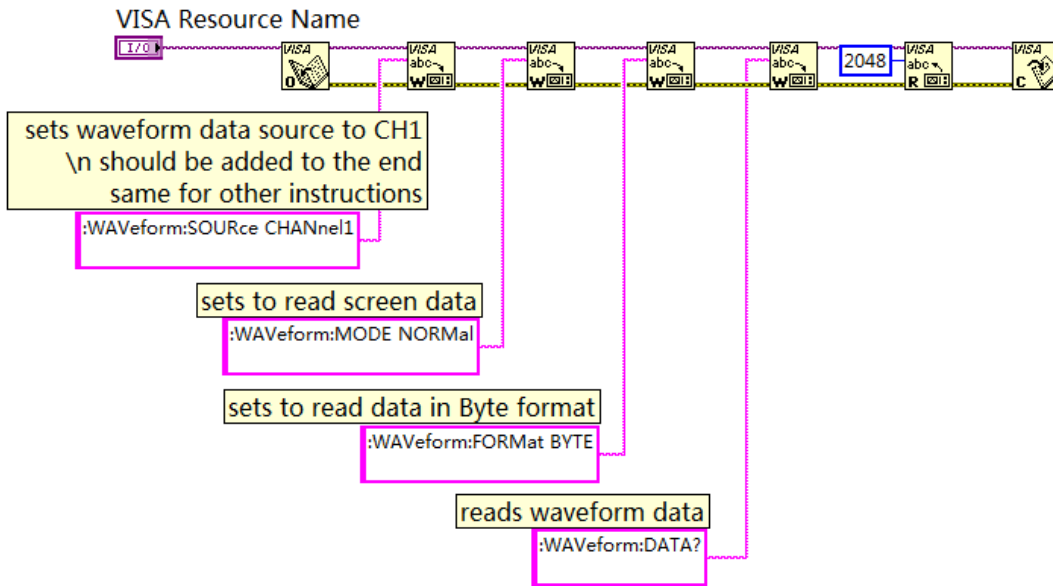

- The data format is TMC header + waveform data points + terminator. The TMC header is in #NXXXXXX format, wherein, # is the TMC header denoter, N represents that there are N bytes following. The length of the waveform data points is described in ASCII character, and the terminator represents the ending of the communication. For example, for #9000001000XXXX, 9 bytes are used to describe the length of the data, 000001000 represents the length of the waveform data (namely 1000 bytes). Use the following block diagram to obtain the number of bytes that the TMC header occupies. Ignore the TMC header and delete the terminator at the end of the waveform data, and transfer the waveform data to the byte data and display it on the waveform diagram controls.

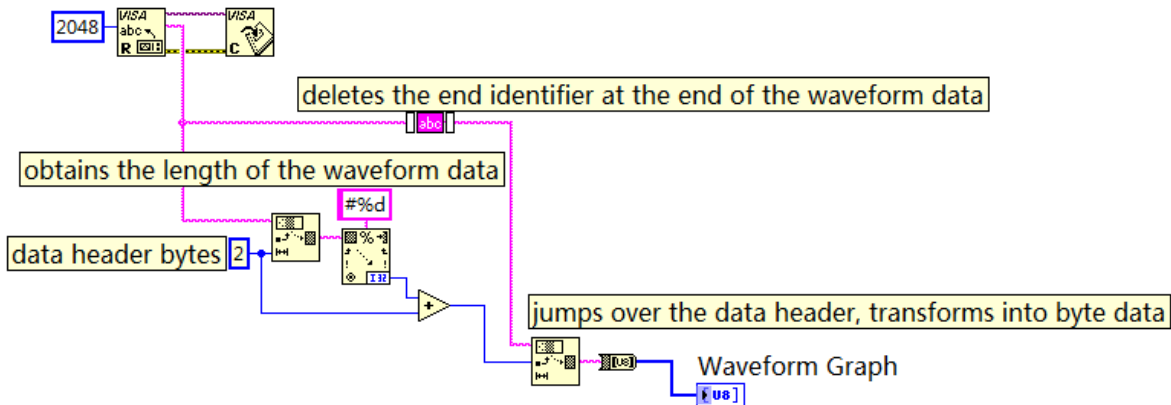

The available functions used in the above block diagram as as follows:

### String Subset

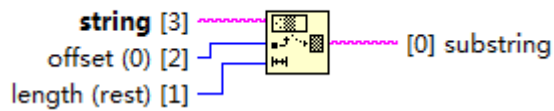

Used to obtain the TMC header "#N". After obtaining the number of bytes that the TMC header occupies, ignore the data header to obtain the waveform data strings.

### Scan From String

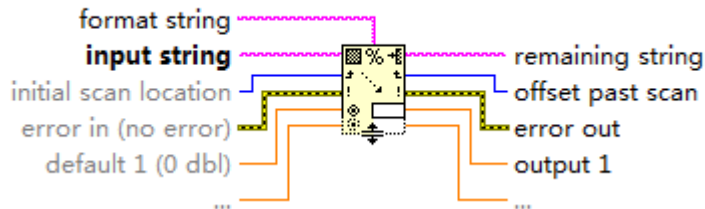

Used to obtain the waveform data length bytes.

### Trim Whitespace.vi (4803)

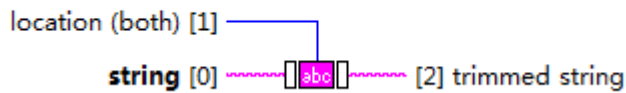

Used to delete the terminator at the end of the waveform data.

### String To Byte Array



Used to transfer waveform data strings to the byte group.

8. The complete program block diagram is as shown in the figure below.

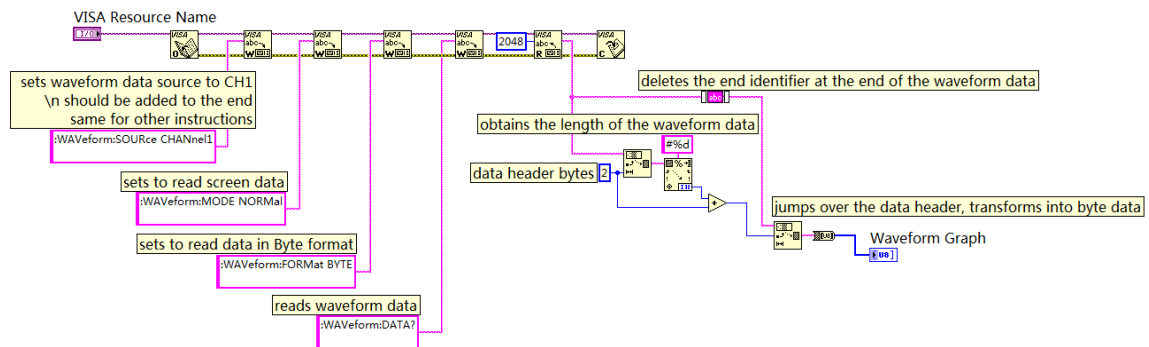

9. Select the device resource from the **VISA Resource Name** list box and run the program.

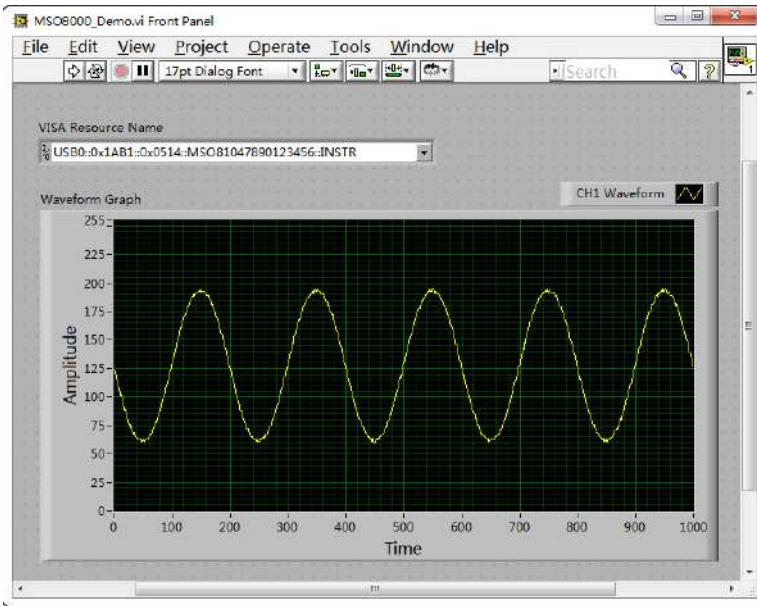

## Visual Basic Programming Example

**Program used in this example:** Visual Basic 6.0

**Function realized in this example:** control the on/off state of any channel.

Enter the Visual Basic 6.0 programming environment, and perform the following procedures.

1. Build a standard application program project (Standard EXE), and name it "Demo".
2. Click **Project** → **Add Module** to open the **Add Module** dialog box. In the dialog box, click the **Existing** tab to search for the visa32.bas file in the "include" folder under the NI-VISA installation path and add the file.

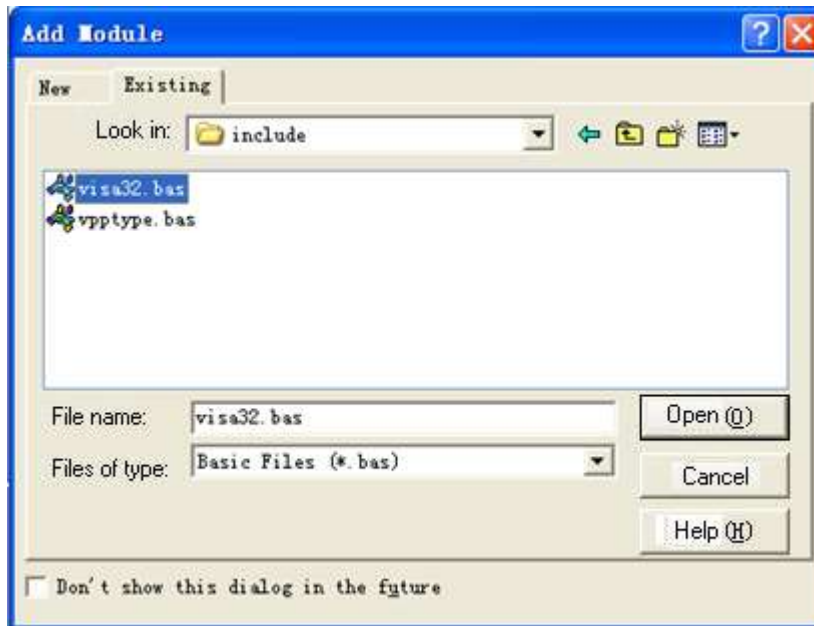

3. In the **Demo** dialog box, add four buttons to represent CH1 to CH4 respectively. Add four Labels (Label1(0), Label1(1), Label1(2) and Label1(3)) to represent the statuses of CH1 to CH4 respectively (when the channel is enabled, it displays the color of the channel; when the channel is disabled, it displays gray), as shown in the figure below.

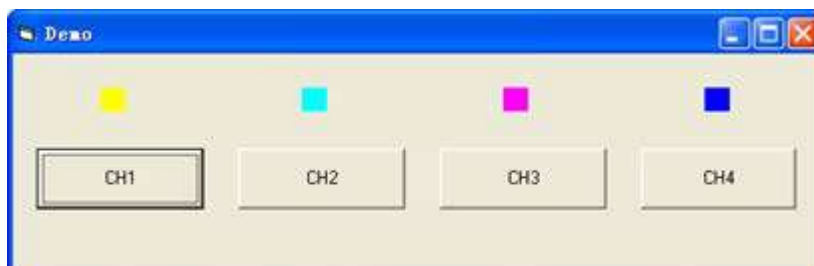

4. Click **Project** → **Project1 Properties** to open the **Project1 – Project Properties** dialog box. In the dialog box, click on the **General** tab and select **Form1** from the drop-down list under **Startup Object**.
5. Double-click **CH1** to enter the programming environment. Add the following codes to control CH1-CH4. The codes of CH1 are as shown below; the codes of the other channels are similar.

```
Dim defrm As Long
Dim vi As Long
Dim strRes As String * 200
Dim list As Long
Dim nmatches As Long
Dim matches As String * 200 ' Reserve the obtained device number
Dim s32Disp As Integer
' Obtain the usb resource of visa
Call viOpenDefaultRM(defrm)
Call viFindRsrc(defrm, "USB?* ", list, nmatches, matches)
' Turn on the instrument
Call viOpen(defrm, matches, 0, 0, vi)
' Send a command to query the status of CH1
Call viVPrintf(vi, ":CHAN1:DISP?" + Chr$(10), 0)
' Obtain the status of CH1
Call viVScanf(vi, "%t", strRes)
s32Disp = CInt(strRes)
If (s32Disp = 1) Then
' Send the setting command
Call viVPrintf(vi, ":CHAN1:DISP 0" + Chr$(10), 0)
Label1(0).ForeColor = &H808080 'Gray
Else
Call viVPrintf(vi, ":CHAN1:DISP 1" + Chr$(10), 0)
Label1(0).ForeColor = &HFFFF& 'Yellow
End If
' Close the resource
Call viClose(vi)
Call viClose(defrm)
```

6. Save and run the project to obtain a single exe program for demo. When the oscilloscope is correctly connected to the PC, you can control the on/off status of any channel.

## Visual C++ Programming Example

**Program used in this example:** Visual C++ 6.0

**Function realized in this example:** search for the instrument address, connect to the instrument, send and read commands.

Enter the Visual C++ 6.0 programming environment, and perform the following procedures.

1. Create a MFC project based on a dialog box.
2. Click **Project** → **Settings** to open the Project Setting dialog box. In the dialog box, click the **C/C++** tab, select **Code Generation** from the drop-down list under **Category**. Choose **Debug** **Multithreaded DLL** from the drop-down list under **Use run-time library**. Click **OK** to close the dialog box.

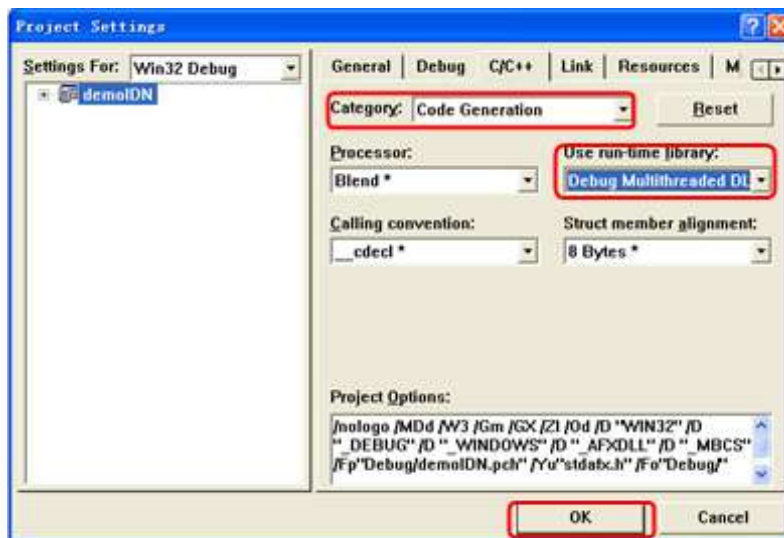

3. Click **Project** → **Settings** to open the **Project Setting** dialog box. In the dialog box, click the **Link** tab, add **visa32.lib** under **Object/library modules**, then click **OK** to close the dialog box.

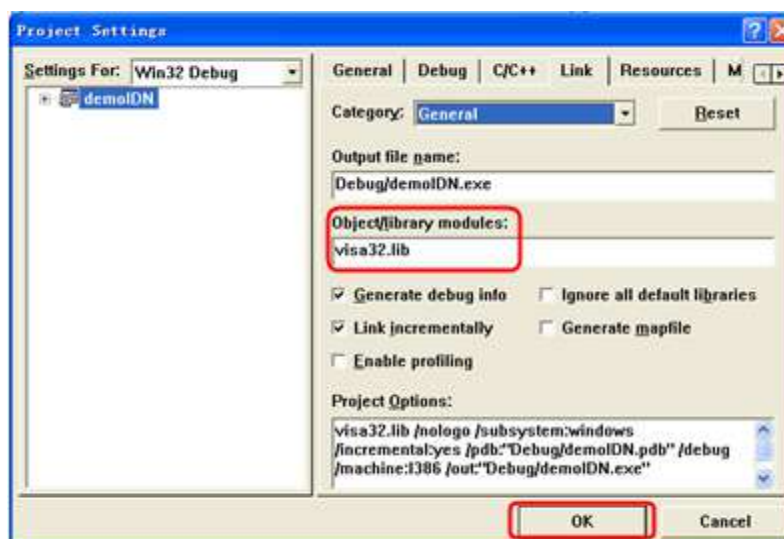



- 4. Click **Tools** → **Options** to open the **Options** dialog box. Then, click the **Directories** tab. Select **Include files** from the drop-down list under **Show directories for**. Double click the empty space under **Directories** to enter the specified path of Include files: C:\Program Files\IVI Foundation\VISA\WinNT\include. Click **OK** to close the dialog box. Select **Library files** from the drop-down list under **Show directories for**. Double-click the empty space under **Directories** to enter the specified path of Library files: C:\Program Files\IVI Foundation\VISA\WinNT\lib\msc. Click **OK** to close the dialog box.

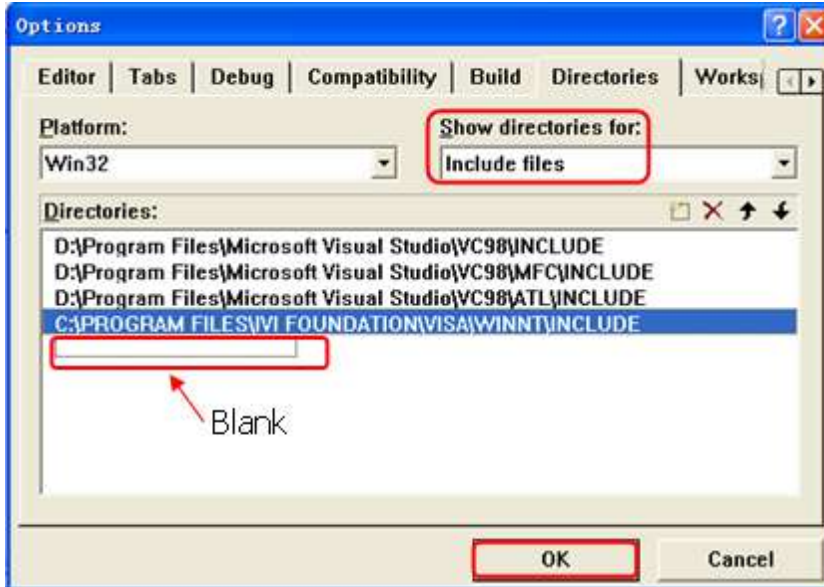

**Note:** By now, VISA library has been added.

- 5. Add the **Text**, **Combo Box**, **Button**, and **Edit Box** controls. The layout interface for adding controls is as follows:



- 6. Modify the control attributes.
  - 1) Name **Text** as "Command".
  - 2) Open the **Data** item in **Combo Box** attribute and input \*IDN? Manually.
  - 3) Open the **General** item in **Edit Box** attribute and select **Disabled**.
  - 4) Name **Button** as **Send and Read**.



7. Add the variables **m\_combox** and **m\_receive** to the **Combo Box** and **Edit Box** controls respectively.

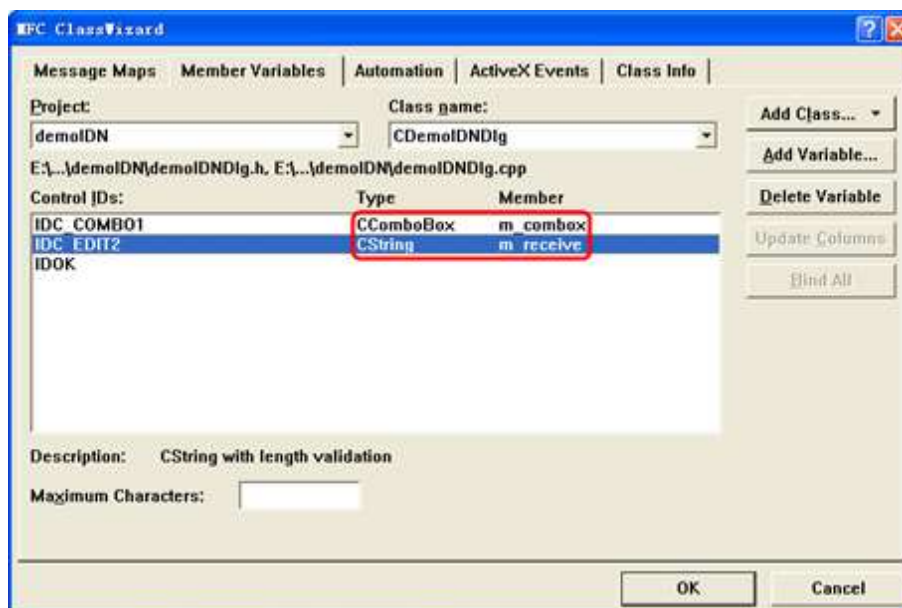
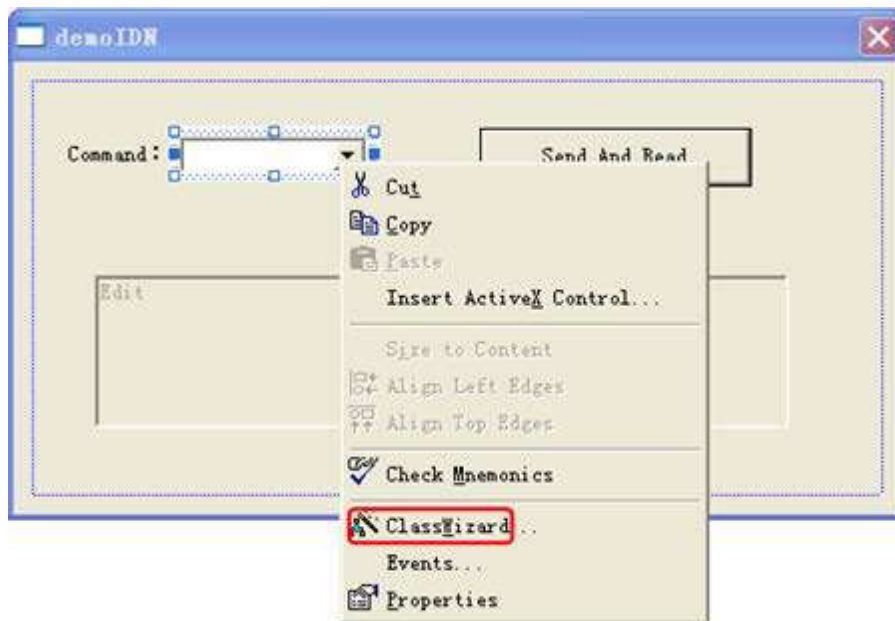

8. Add codes.  
Double-click **Send and Read** to enter the programming environment. Declare the **#include <visa.h>** of the VISA library in the header file and then add the following codes:

```
ViSession defaultRM, vi;
char buf [256] = {0};
CString s,strTemp;
char* stringTemp;
```

```
ViChar buffer [VI_FIND_BUFLen];
ViRsrc matches=buffer;
ViUInt32 nmatches;
ViFindList list;
```

```
viOpenDefaultRM (&defaultRM);  
//Acquire the USB resource of VISA  
viFindRsrc(defaultRM, "USB?* ", &list,&nmatches, matches);  
viOpen (defaultRM,matches,VI_NULL,VI_NULL,&vi);  
  
//Send the command received  
m_combox.GetLBText(m_combox.GetCurSel(),strTemp);  
strTemp = strTemp + "\n";  
stringTemp = (char*)(LPCTSTR)strTemp;  
viPrintf (vi,stringTemp);  
  
//Read the results  
viScanf (vi, "%t\n", &buf);  
  
//Display the results  
UpdateData (TRUE);  
m_receive = buf;  
UpdateData (FALSE);  
viClose (vi);  
viClose (defaultRM);
```

9. Save, compile, and run the project to obtain a single exe file. When the oscilloscope is correctly connected to the PC, enter a command (for example, \*IDN?) and click **Send and Read** to execute the command. Then, the reading results will be returned.

